

V
A
I
S
H
A
N
A
V
S
U
R
G
I
C
A
L



**General Surgical
Instruments**

Vaishanav Surgial Co.

Following the 21st century vision of becoming a true global leader who can make its Customers worldwide through its quality products and services. We are dedicated to manufacturing and marketing instruments which provide practical Solutions to real life problems, And meet the needs of our customers. We insist on high quality, efficient manufacturing Teamwork, and integrity, growing from our deep respect and honour for god, our Employees, our vendors, our customers and all our other stakeholders.

We stand behind every product we offer. Each of us, from the production department To the sales department makes customer satisfaction a top priority.

The careful management of people and projects ensures we continue to enjoy our Reputation for providing excellent quality services to our customers. The most important part of our philosophy is to work in partnership with clients and This requires, in our view, direct contact between our clients and us from the word go.

We aim:

- >> To listen to our customers and exceed their expectations, ensuring they are completely Satisfied with our products, services and support so that they will continue working with us.
- >> To continue expanding our research programs in progressive technologies.
- >> To secure international recognition by adopting a global rather than local perspective And by achieving excellence in the quality of our instruments.
- >> To continue building our excellent team of top professionals through controlled expansion,

Diagnostic Instruments	2 – 4	01
Probes, Suction Instruments	5, 6	01
Scissors	8 – 20	02
Scalpels & Knives	22 – 24	03
Dressing & Tissue Forceps	26 – 40	04
Sponge Forceps	42 – 44	05
Hemostatic Forceps	46 – 62	06
Needle Holders, Suture	64 – 76	07
Bandage and Plaster Instruments	78 – 82	08
Intestinal, Rectal	84 – 94	09
Gynecology	96 – 120	10
Orthopedic Instruments	122 – 156	11

Retractors	158 – 190
Cardiovascular Instruments	192 – 206
Ear Instruments	208 – 218
Laryngoscopes	220 – 230
Dermatology	232 – 234
Sterilization	236 – 240
Thoracic Instruments	242 – 248
Neurosurgery	250 – 260
Urology Instruments	262 – 270
Nasal Instruments	272 – 282
Mouth & Throat Instruments	284 – 291
Alphabetical Index	293 – 298
Numerical Index	299 – 303

DIAGNOSTICS & SUCTION INSTRUMENTS





1/2

BUCK
SF-01-10001
18 cm / 7"

Reversible Head



1/2

BABINSKY
SF-01-10002
22 cm / 8 3/4"



1/2

DEJRINE
SF-01-10003
21 cm / 8 1/4"

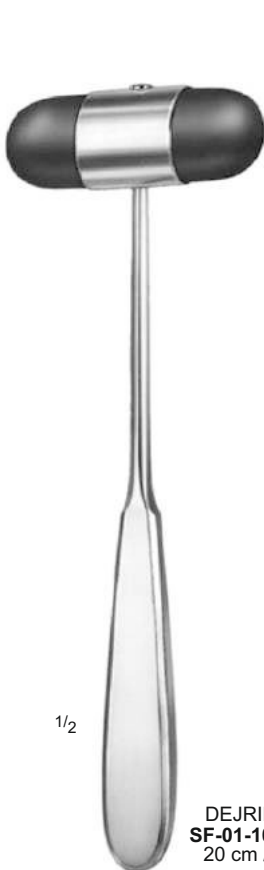

1/2

DEJRINE
SF-01-10004
20 cm / 8"

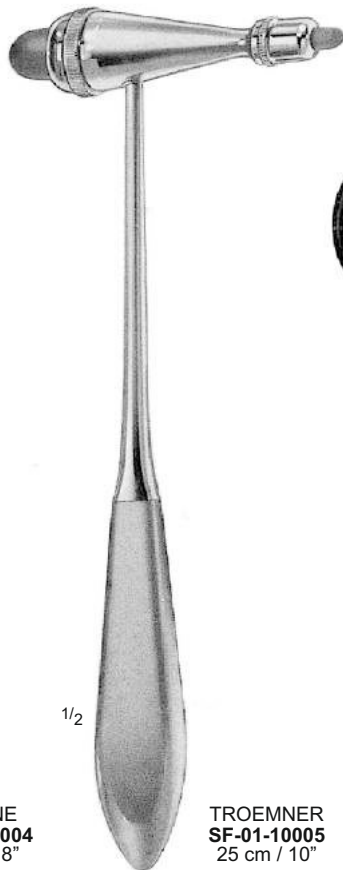

1/2

TROEMNER
SF-01-10005
25 cm / 10"



1/2

BERLINER
SF-01-10006
20 cm / 8"



1/2

TAYLOR
SF-01-10007
20 cm / 8"



PINARD
SF-01-10008
15 cm / 6"



1/2

WARTENBERG
SF-01-10009
18 cm / 7"



1/2

PROFESSIONAL
SF-01-10010
19 cm / 7 1/2"



ANEROID
SPHYGMOMANOMETER
SF-01-10011

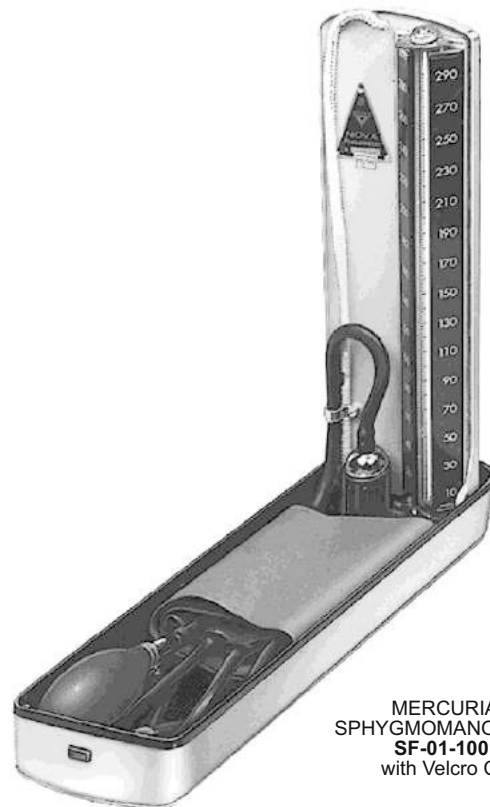

MERCURIAL
SPHYGMOMANOMETER
SF-01-10012
with Velcro Cuff



ZIEGLER (COMPLETE)
SF-01-10013



CASTROVIEJO
SF-01-10014
8.5 cm / 3 1/4"

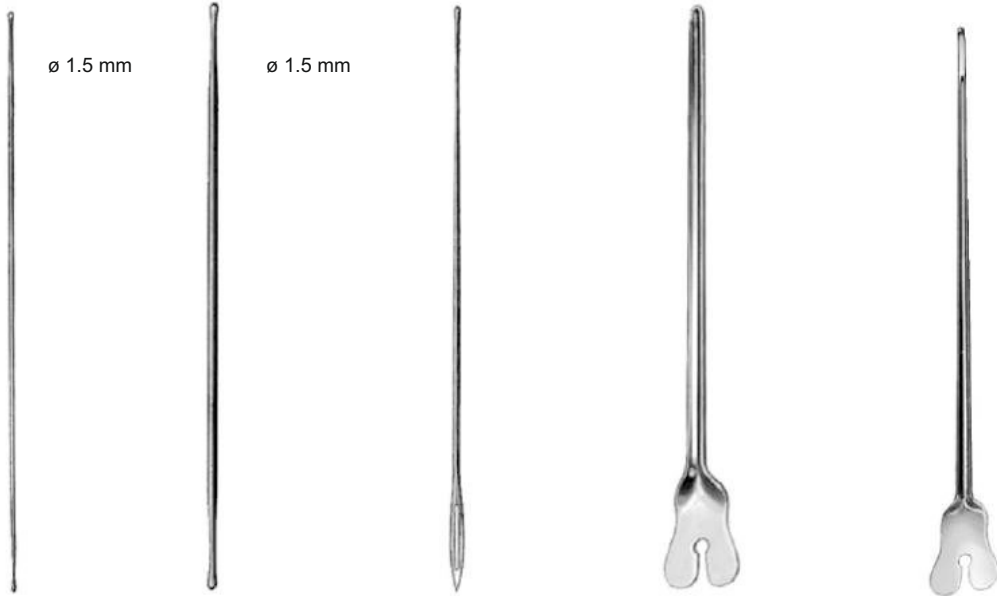

NELATON

14.5cm / 5 1/2"	SF-01-10015	SF-01-10019	SF-01-10023	SF-01-10027	-
16 cm / 6 1/4"	SF-01-10016	SF-01-10020	SF-01-10024	SF-01-10028	SF-01-10031
18 cm / 7"	SF-01-10017	SF-01-10021	SF-01-10025	SF-01-10029	-
20 cm / 8"	SF-01-10018	SF-01-10022	SF-01-10026	SF-01-10030	-

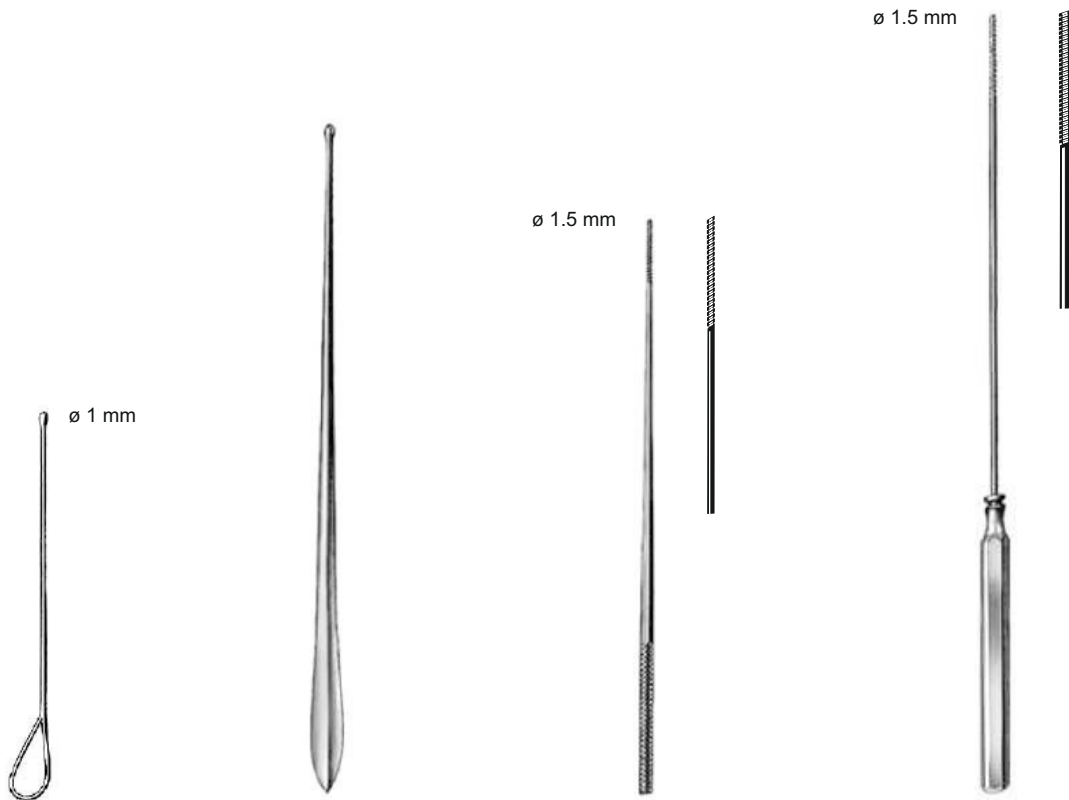

STACKE
SF-01-10032
10.5 cm / 4 1/4"

MARTYLE
SF-01-10033 - 14.5 cm / 5 1/2"
SF-01-10034 - 16 cm / 6 1/4"

FARREL (FROHN)
SF-01-10035 - 12 cm / 4 3/4", ø 0.9 mm
SF-01-10036 - 14.5 cm / 5 1/2", ø 0.9 mm
SF-01-10037 - 16 cm / 6 1/4", ø 1.1 mm

SF-01-10038 - 12 cm / 4 3/4"
SF-01-10039 - 14 cm / 5 1/2"
SF-01-10040 - 16 cm / 6 1/4"
SF-01-10041 - 18 cm / 7"

6 mm



SF-01-10042

10 mm



SF-01-10043



POOLE
22 cm / 8 3/4"

6 mm



SF-01-10044

8 mm



SF-01-10045



POOLE
22 cm / 8 3/4"



YANKAUER
SF-01-10047

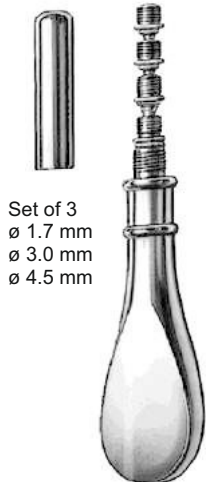

Set of 3
ø 1.7 mm
ø 3.0 mm
ø 4.5 mm

UNIVERSAL
SF-01-10046



12.5 cm / 5" 18 cm / 7"
SF-01-10048 SF-01-10049



FRAZIER

12.5 cm / 5" 18 cm / 7"
SF-01-10050 SF-01-10051

SCISSOR



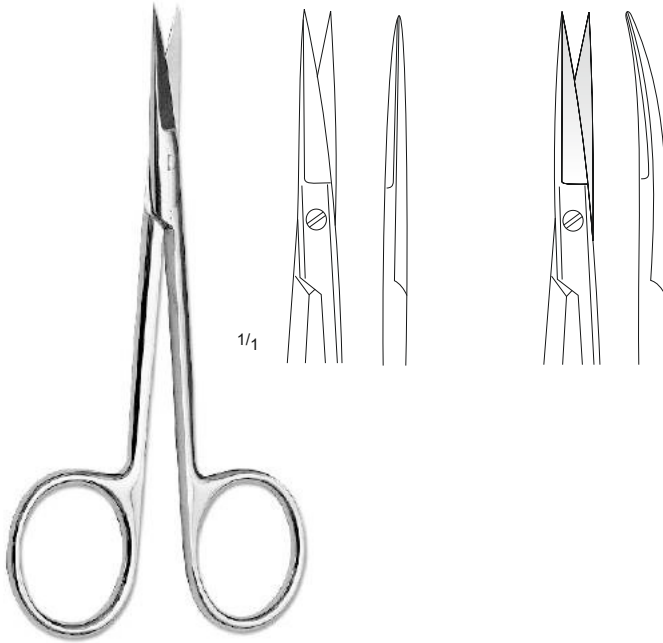

IRIS

Straight

Curved

SF-01-10052 10.5 cm / 4¹/₈" SF-01-10054

SF-01-10053 11.5 cm / 4¹/₂" SF-01-10055

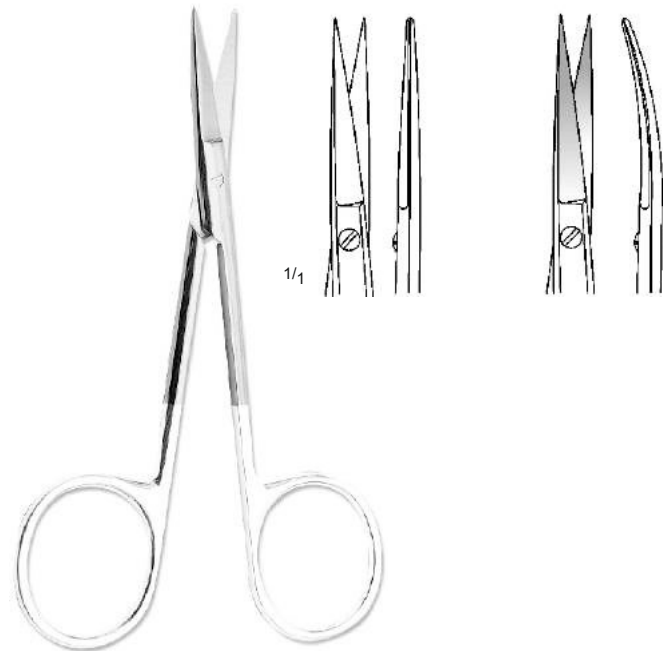

IRIS T/C

Straight

Curved

SF-01-10056 11.5 cm / 4 1/2" SF-01-10057

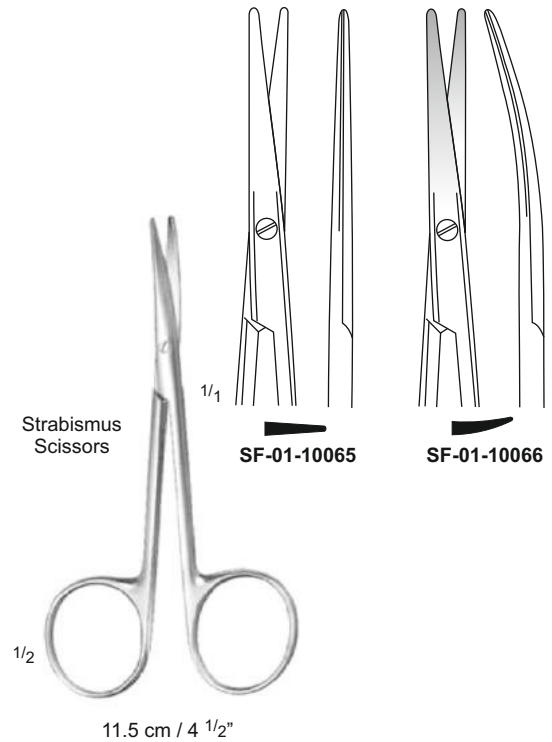
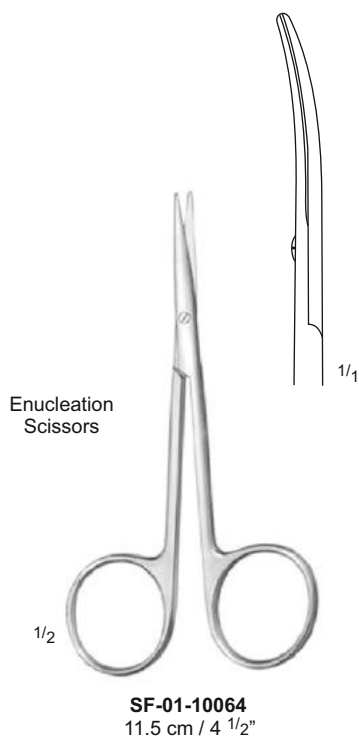
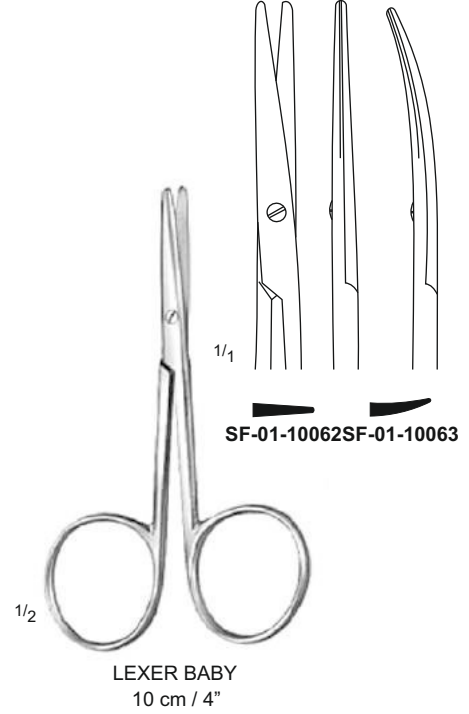
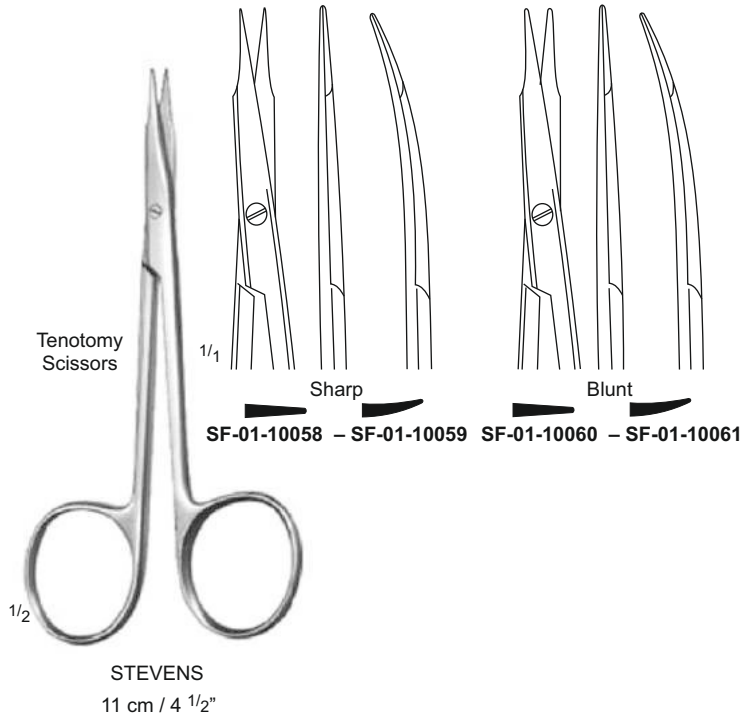

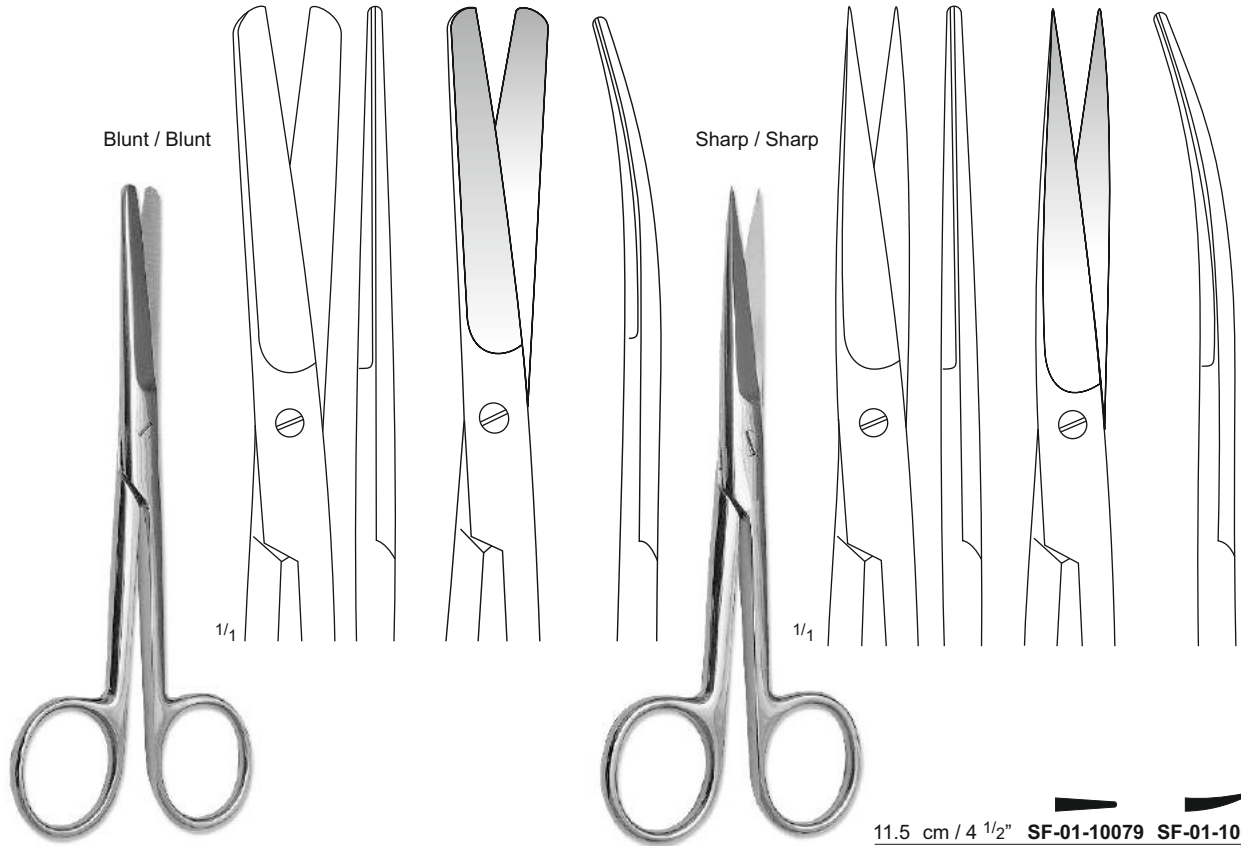

11.5 cm / 4 1/2"	SF-01-10067	SF-01-10073
13 cm / 5"	SF-01-10068	SF-01-10074
14.5cm / 5 3/4"	SF-01-10069	SF-01-10075
15 cm / 6"	SF-01-10070	SF-01-10076
16.5cm / 6 1/2"	SF-01-10071	SF-01-10077
18.5cm / 7 1/4"	SF-01-10072	SF-01-10078

11.5 cm / 4 1/2"	SF-01-10079	SF-01-10085
13 cm / 5"	SF-01-10080	SF-01-10086
14.5 cm / 5 3/4"	SF-01-10081	SF-01-10087
15 cm / 6"	SF-01-10082	SF-01-10088
16.5 cm / 6 1/2"	SF-01-10083	SF-01-10089
18.5 cm / 7 1/4"	SF-01-10084	SF-01-10090

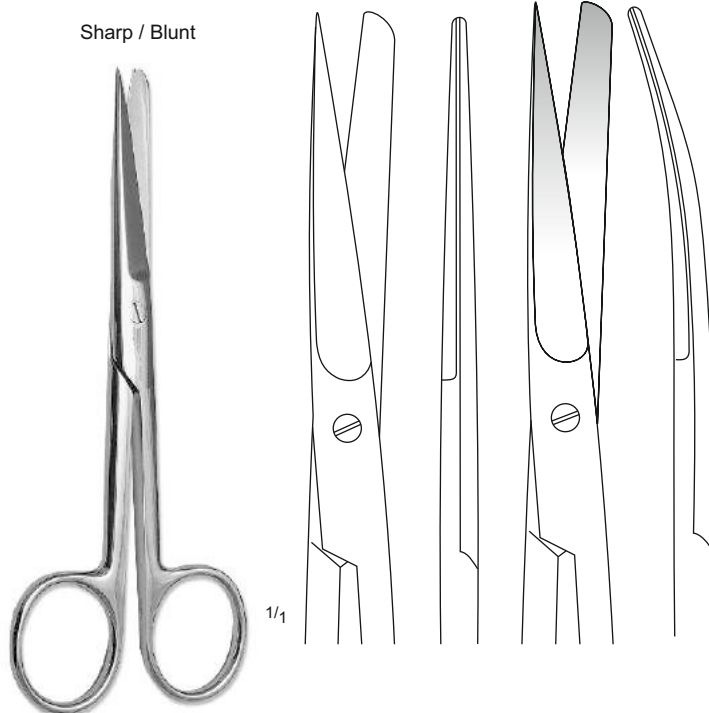



11.5 cm / 4 1/2"	SF-01-10091	SF-01-10097
13 cm / 5"	SF-01-10092	SF-01-10098
14.5 cm / 5 3/4"	SF-01-10093	SF-01-10099
15 cm / 6"	SF-01-10094	SF-01-10000
16.5 cm / 6 1/2"	SF-01-10095	SF-01-10001
18.5 cm / 7 1/4"	SF-01-10096	SF-01-10002



MAYO

1/1



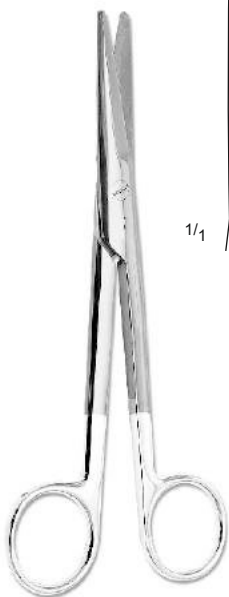



Straight	SF-01-10003	SF-01-10005	SF-01-10007	SF-01-10009	
Curved	SF-01-10004	SF-01-10006	SF-01-10008	SF-01-10010	
	14 cm / 5 1/2"	15.5 cm / 6 1/8"	17 cm / 6 3/4"	23 cm / 9"	

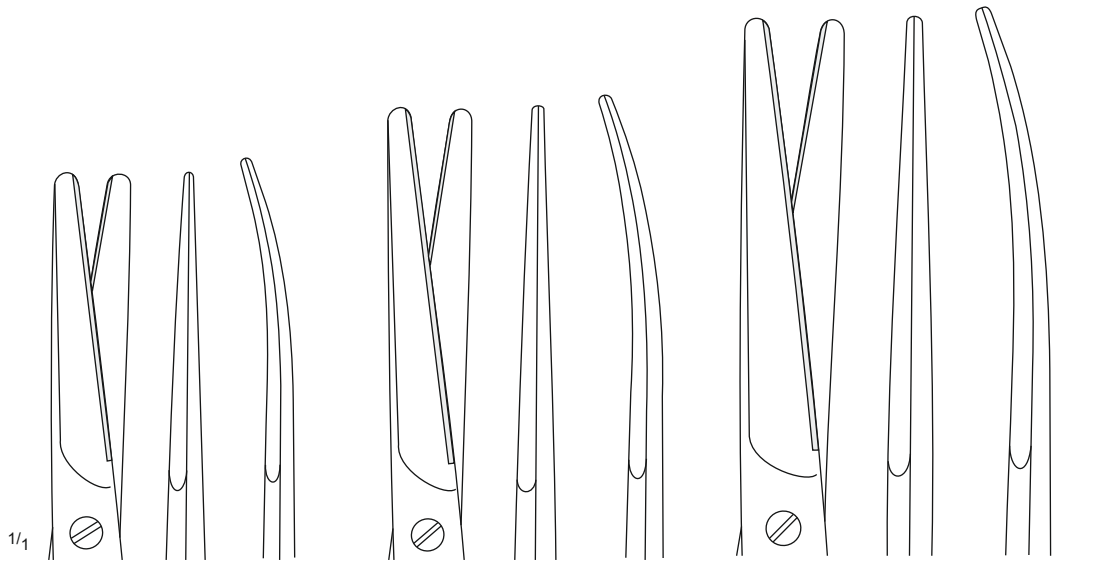

MAYO, T/C

1/1



					
SF-01-10011	SF-01-10012	SF-01-10013	SF-01-10014	SF-01-10015	SF-01-10016
14 cm / 5 1/2"		15.5 cm / 6 1/8"		17 cm / 6 3/4"	

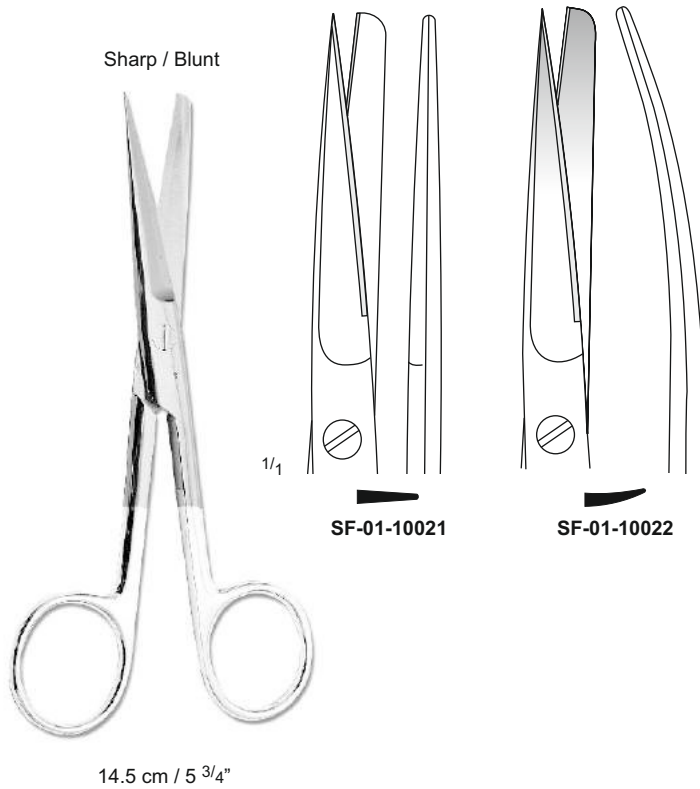
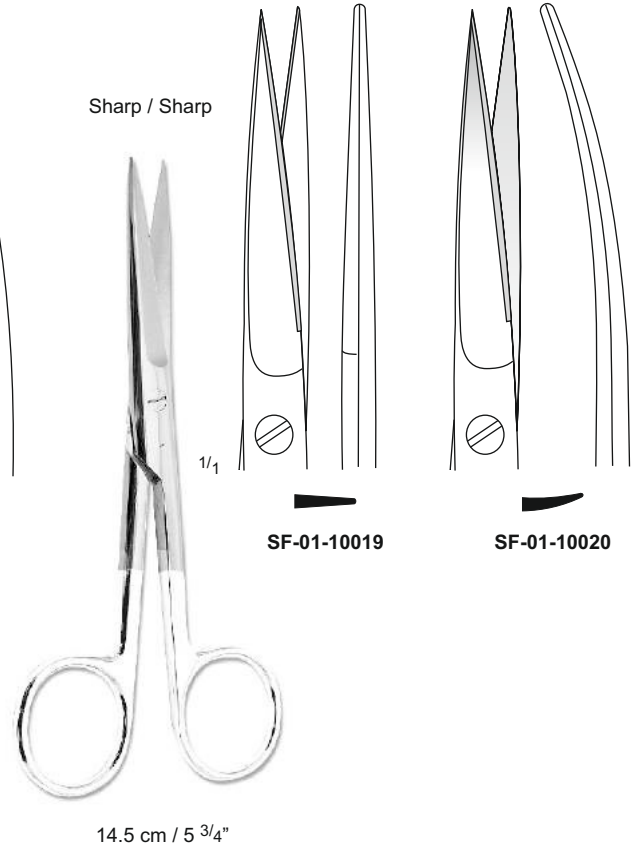
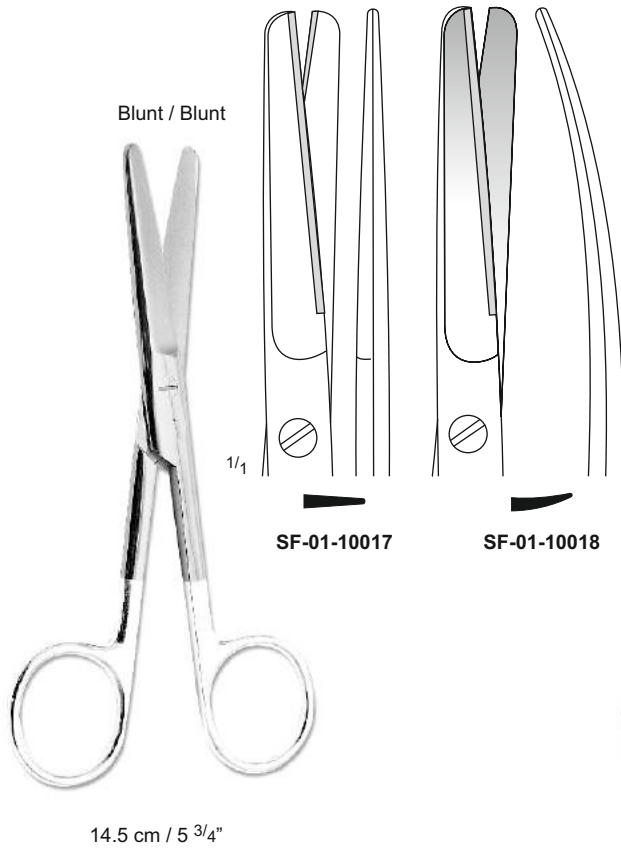



MAYO-STILLE

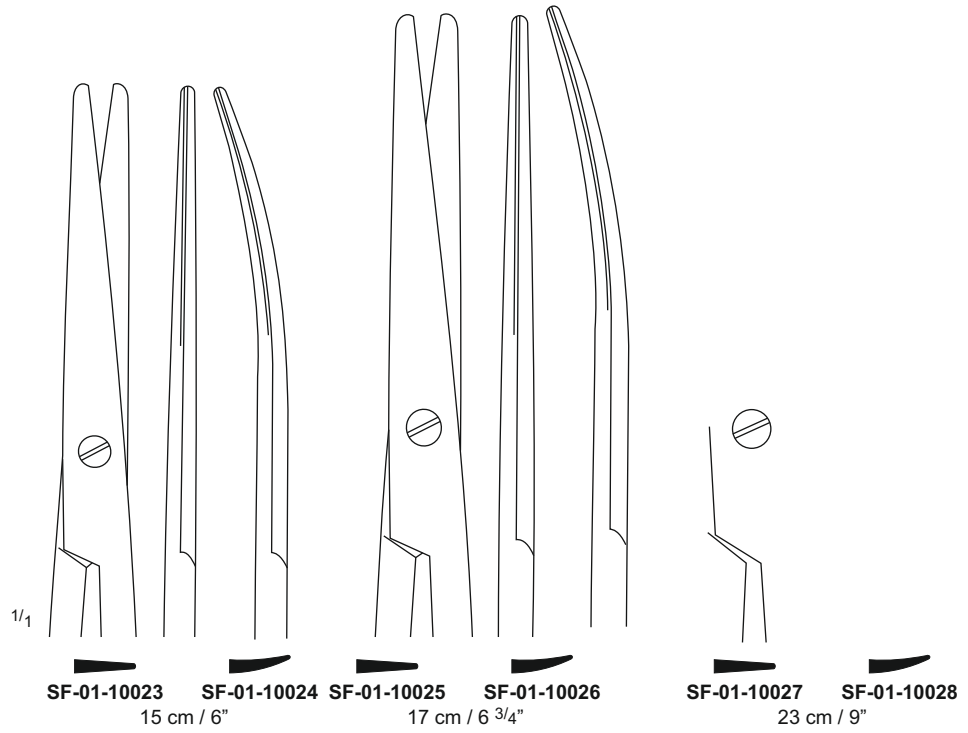

MAYO-STILLE T/C

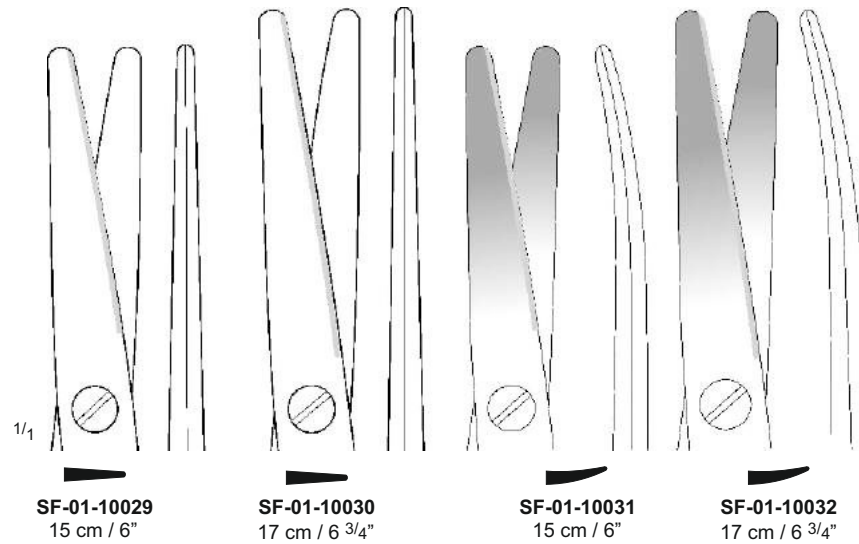

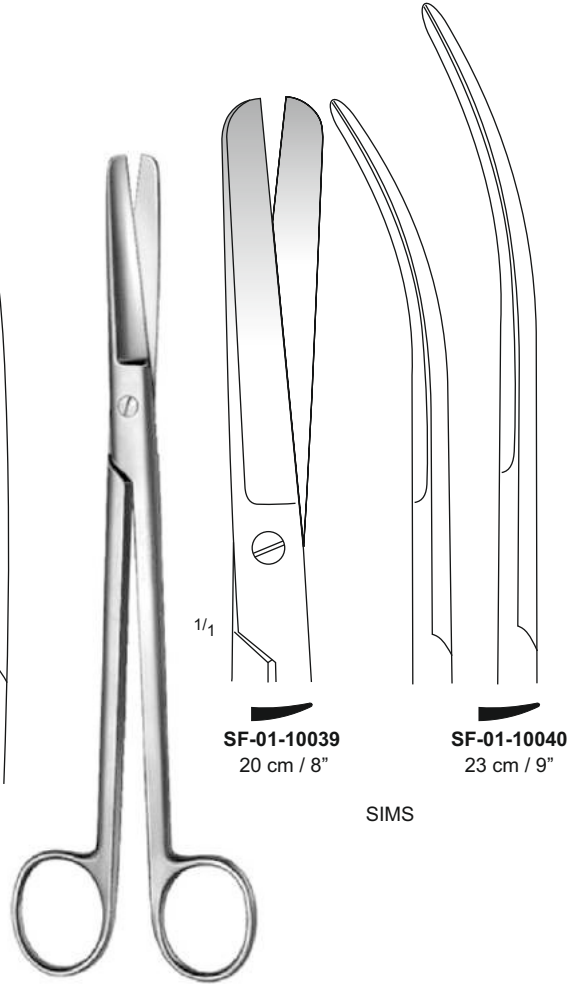
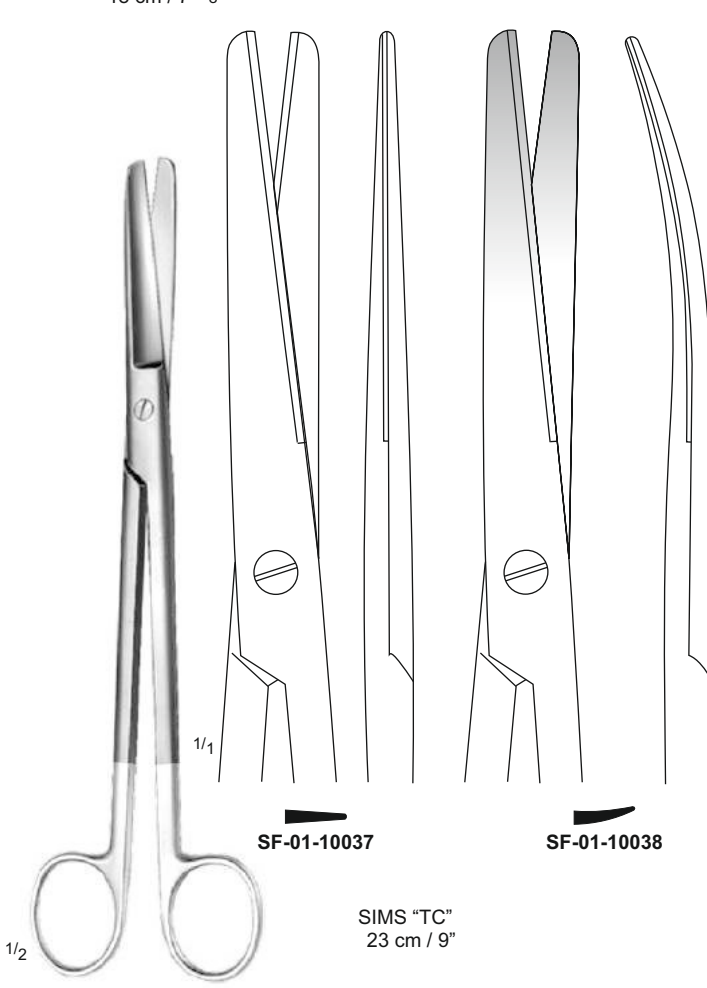
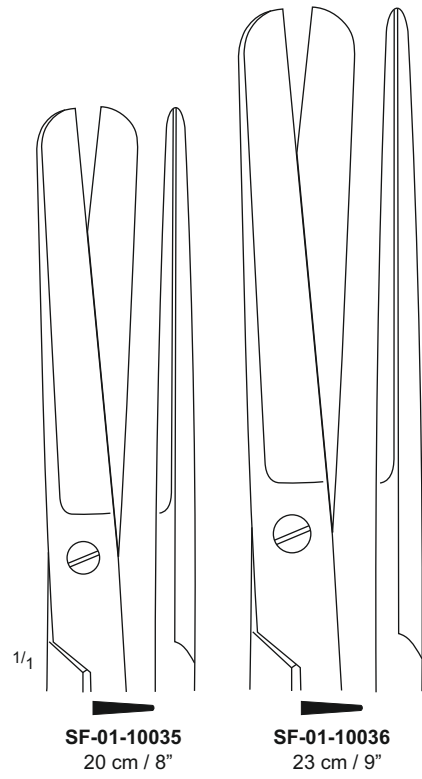

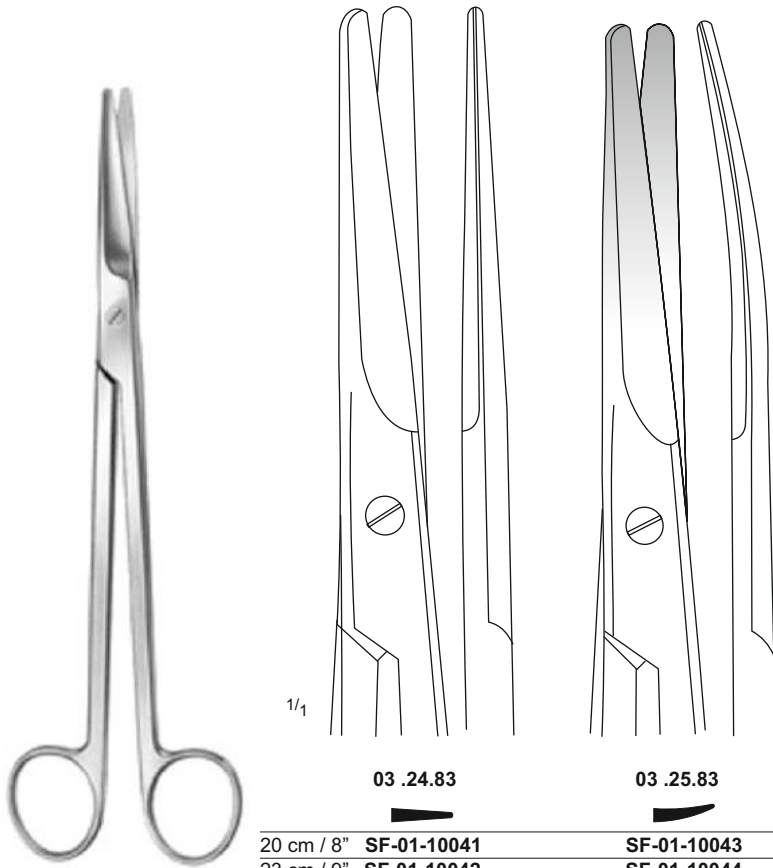

MAYO-HARRINGTON
03 .24-80 – 03 .25.83

03 .24.83

03 .25.83

20 cm / 8" SF-01-10041
23 cm / 9" SF-01-10042

SF-01-10043
SF-01-10044

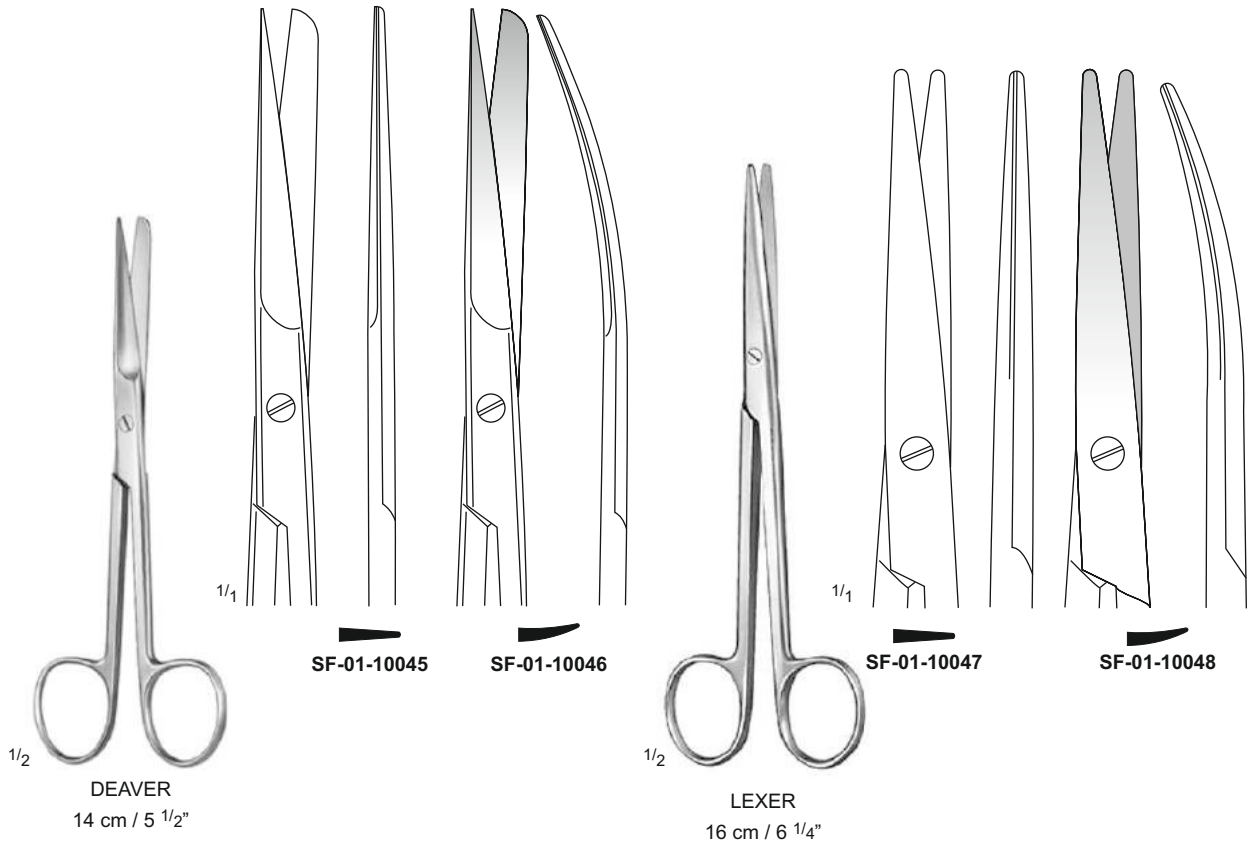

1/2
DEAVER
14 cm / 5 1/2"

1/2
LEXER
16 cm / 6 1/4"

SF-01-10045

SF-01-10046

SF-01-10047

SF-01-10048

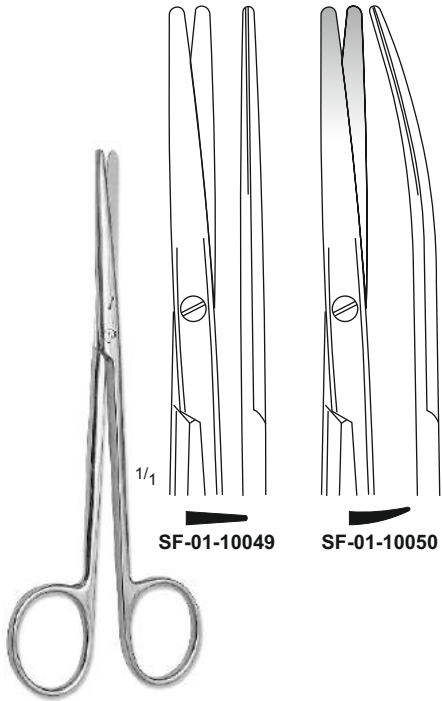

SF-01-10049

SF-01-10050

METZENBAUM
14 cm / 5 1/2"

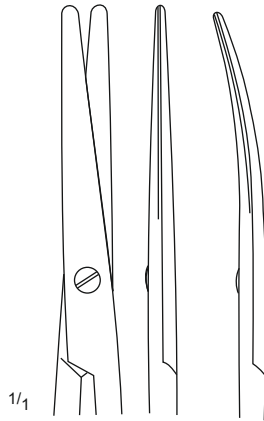

1/4

SF-01-10051

SF-01-10052

18 cm / 7"

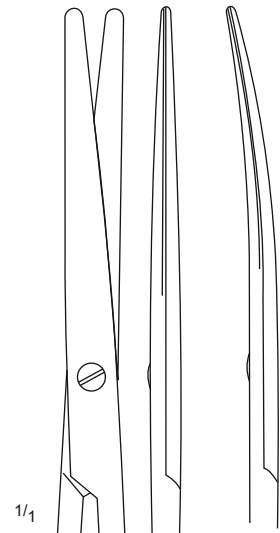

1/4

SF-01-10053

SF-01-10054

20 cm / 8"

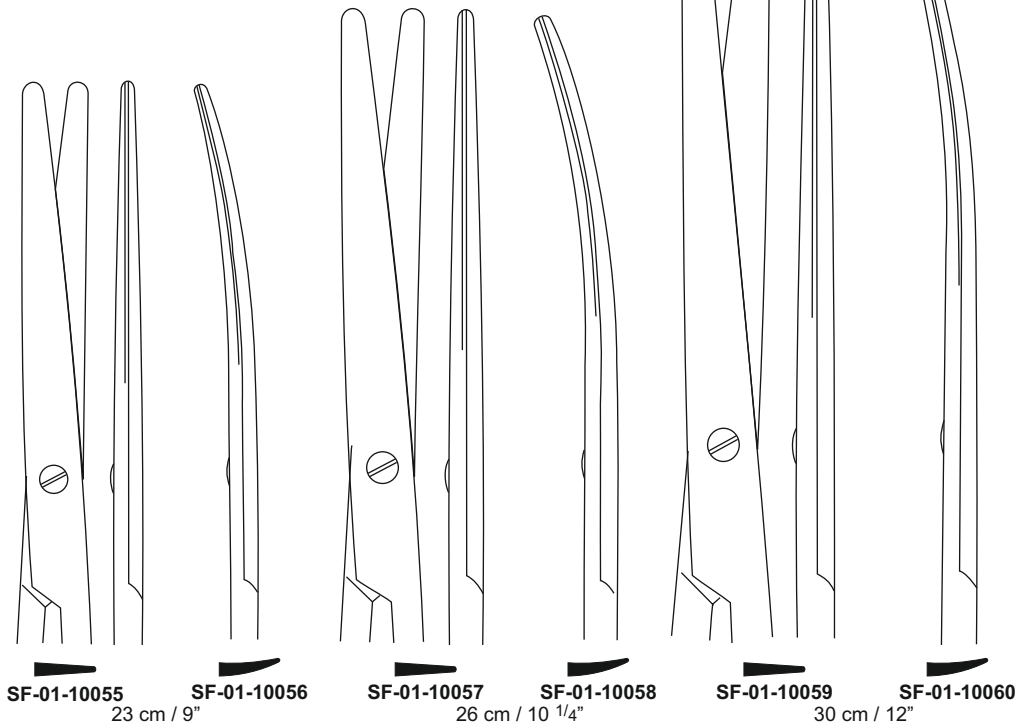

SF-01-10055

SF-01-10056

SF-01-10057

SF-01-10058

SF-01-10059

SF-01-10060

23 cm / 9"

26 cm / 10 1/4"

30 cm / 12"

METZENBAUM (NELSON)

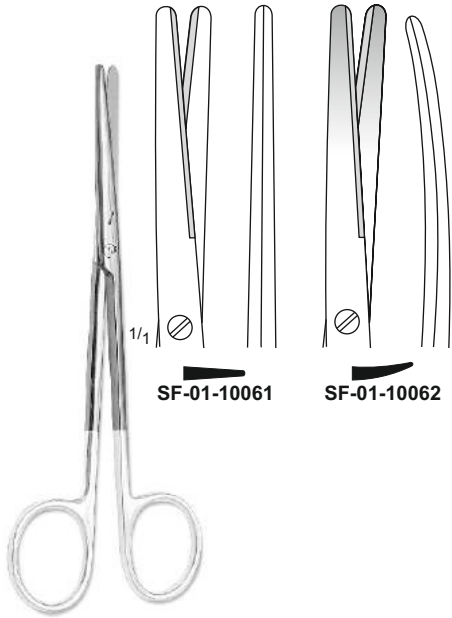

METZENBAUM, T/C
14 cm / 5 1/2"

SF-01-10061

SF-01-10062

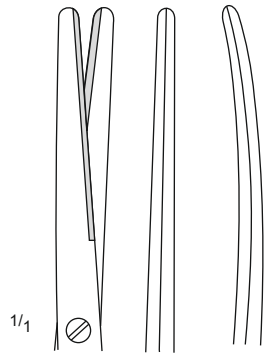

SF-01-10063
18 cm / 7"

SF-01-10064

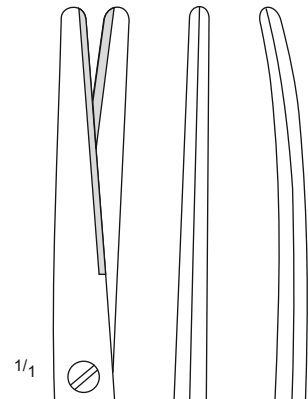

SF-01-10065
20 cm / 8"

SF-01-10066



METZENBAUM T/C
METZENBAUM (NELSON) T/C

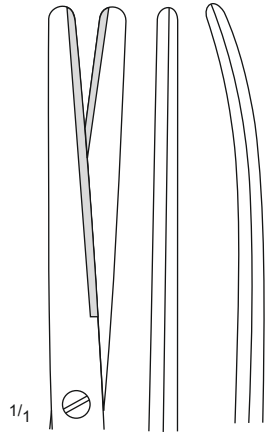

SF-01-10067 SF-01-10068
23 cm / 9"

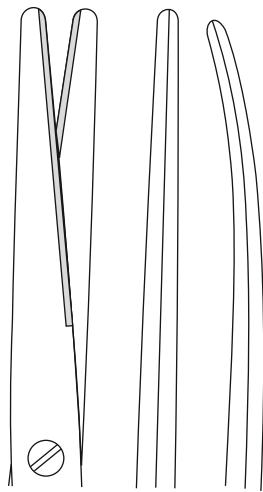

SF-01-10069 SF-01-10070
26 cm / 10 1/4"

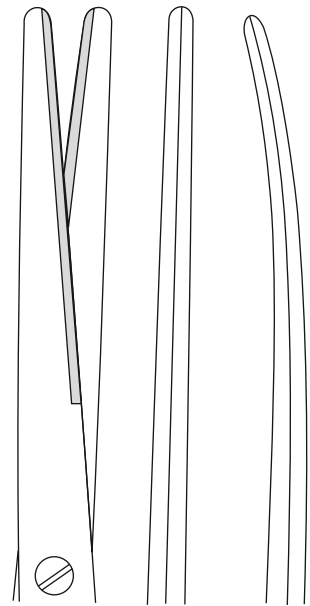

SF-01-10071 SF-01-10072
30 cm / 12"

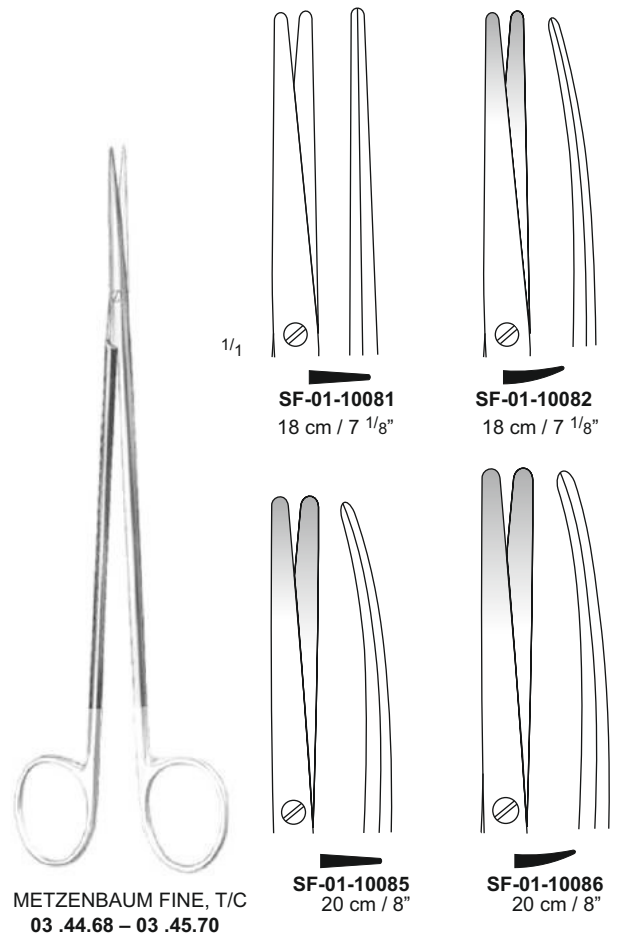
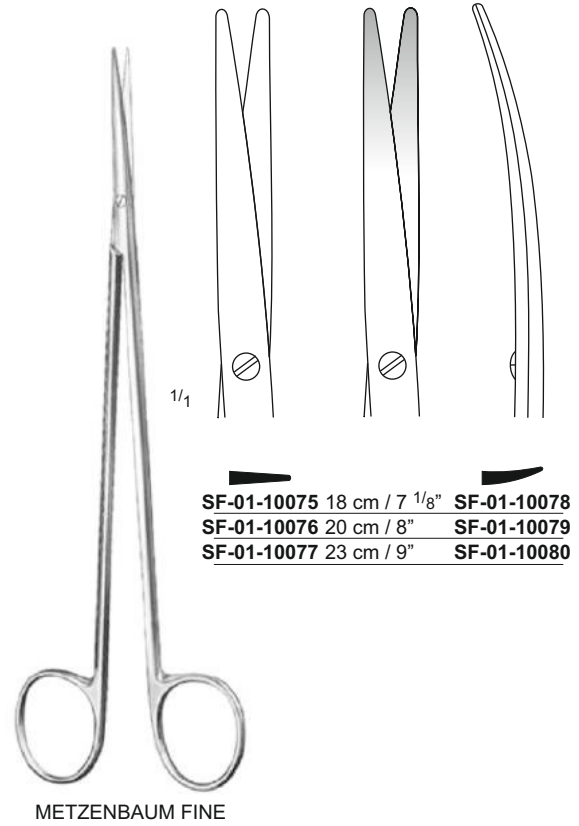
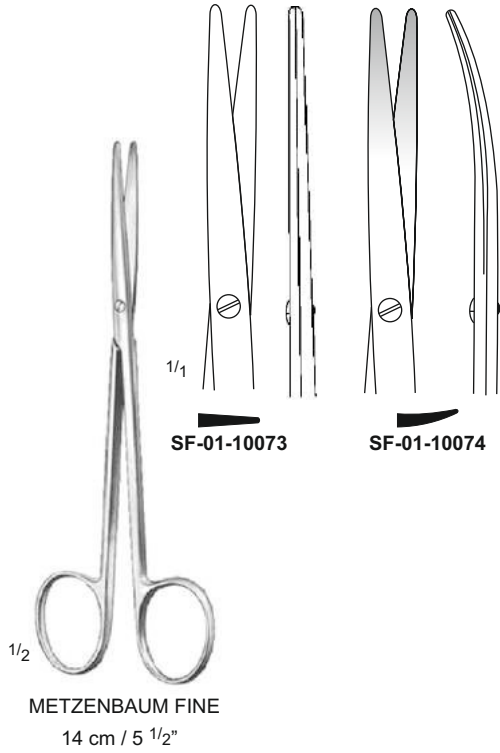

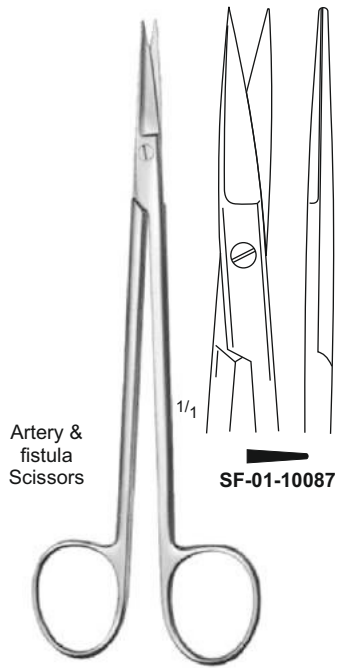

Artery & fistula Scissors

1/1

SF-01-10087

KELLY
16 cm / 6 1/4"

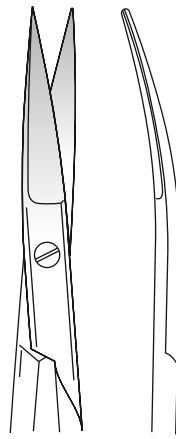

SF-01-10088

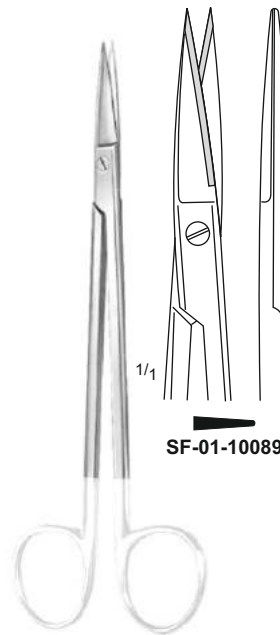

1/1

SF-01-10089

KELLY, T/C
16 cm / 6 1/4"

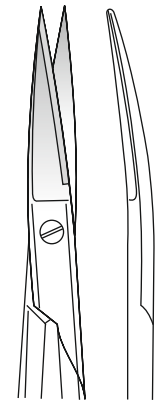

SF-01-10090

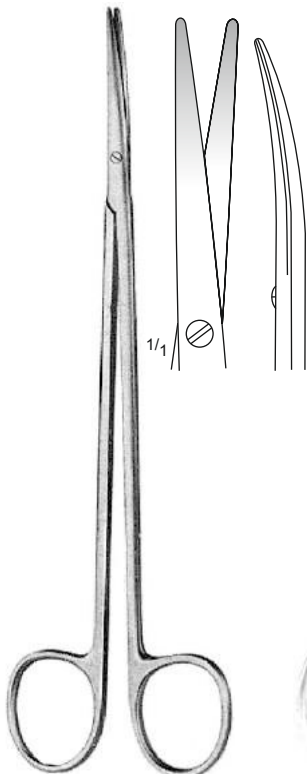

TOENNIS ADSON
SF-01-10091
18 cm / 7 1/8"

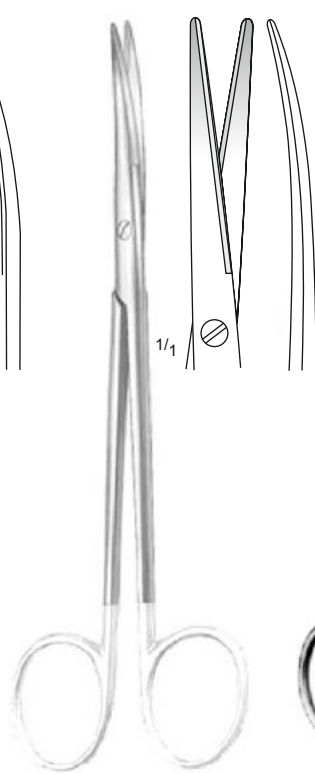

TOENNIS ADSON, T/C
SF-01-10092
18 cm / 7 1/8"

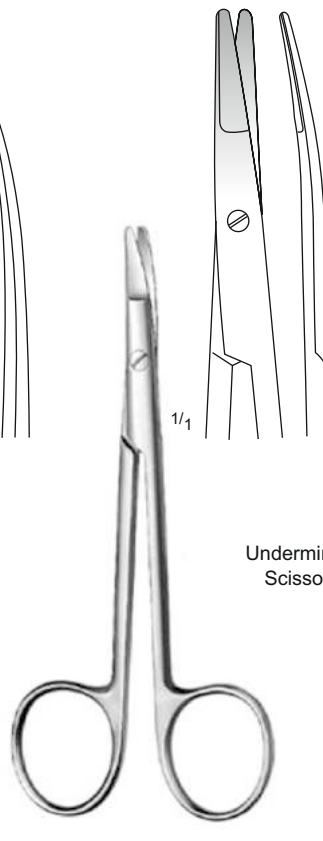

Undermining Scissors

KILNER
SF-01-10093 - 13 cm / 5 1/8"
SF-01-10094 - 15 cm / 6"

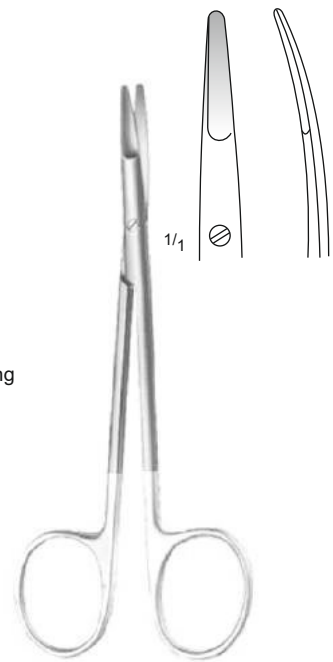

KILNER, T/C
SF-01-10095
13 cm / 5 1/8"

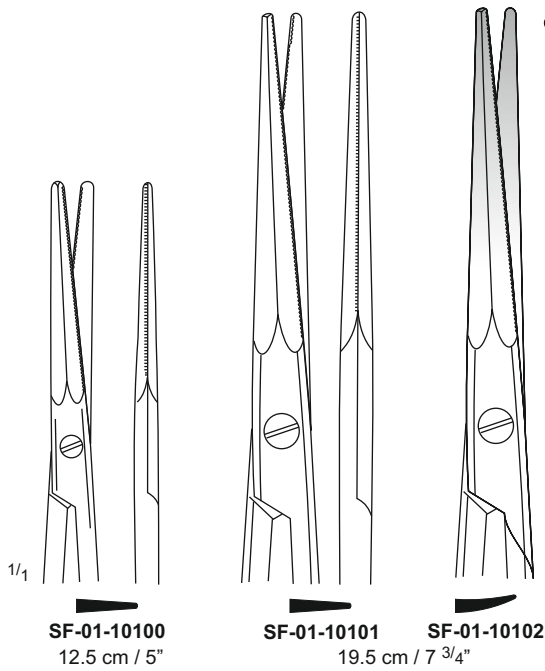
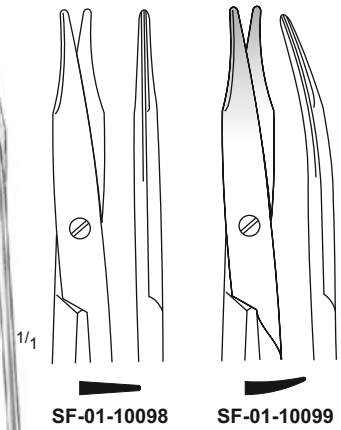
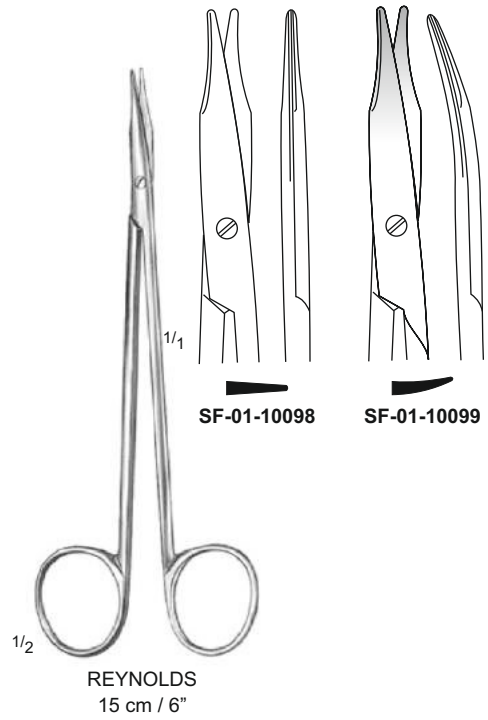
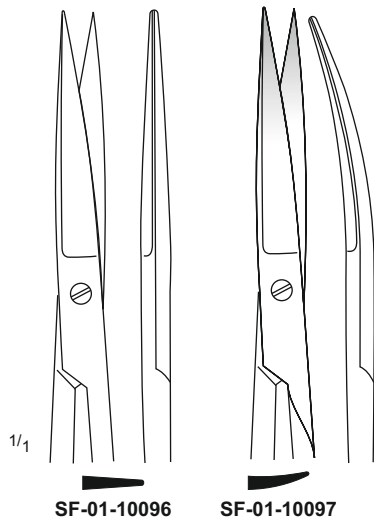

Dissecting Scissors for Plastic Surgery
Blades are outside semisharp
and inside serrated.

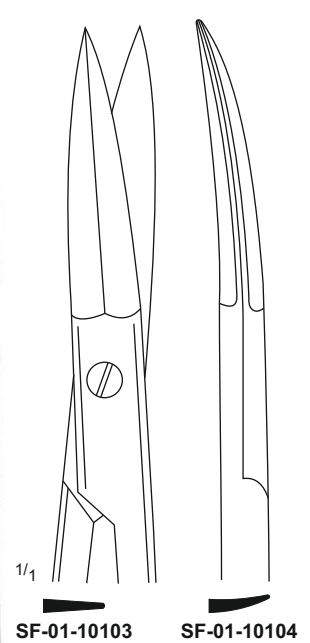
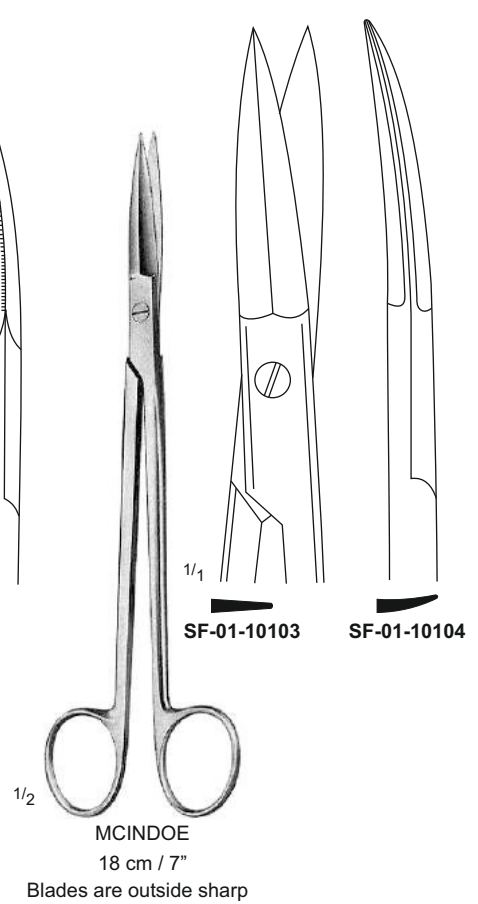

SCALPEL & KNIVES





STANDARD
SF-01-10105
No. 3



SF-01-10106
No. 07



SF-01-10107
No. 7K



SF-01-10108
No. 3L



SF-01-10109
No. 4



SF-01-10010
No. 4L

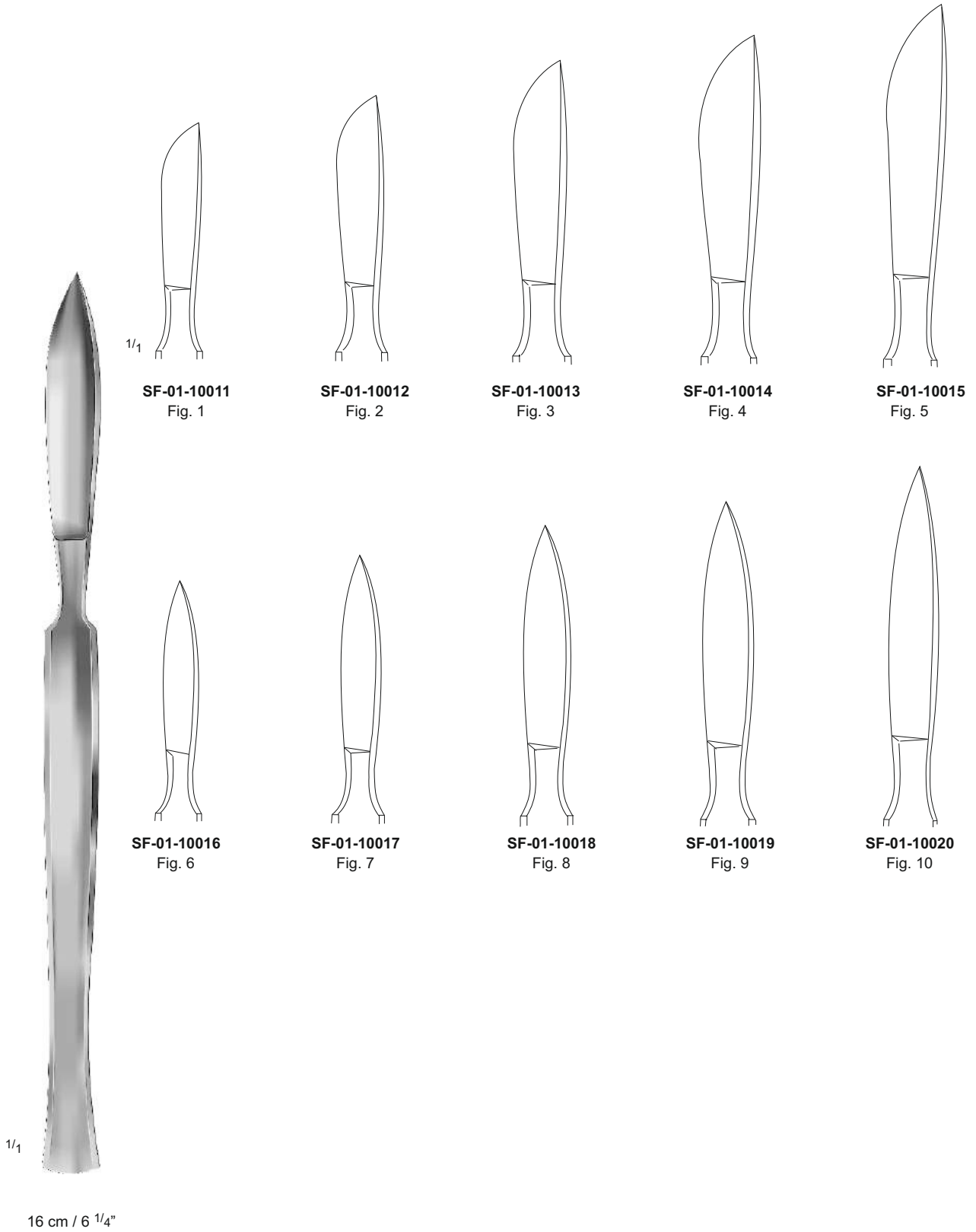



1/2

LISTON

SF-01-10021

Total Length	29 cm / 11 1/2"
Cutting Length	19 cm / 7 1/2"



1/2

LANGENBECK

SF-01-10022

Total Length	18 cm / 7"
Cutting Length	5.5 cm / 2 1/4"

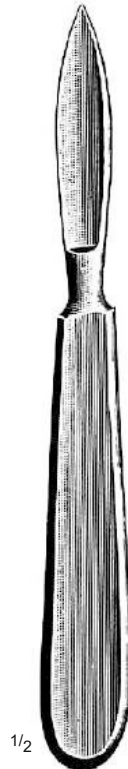

1/2



VIRCHOW

SF-01-10024	– 16 cm / 6 1/4"
SF-01-10025	– 20 cm / 8"
SF-01-10026	– 24 cm / 9 1/2"

DRESSING & TISSUE FORCEPS



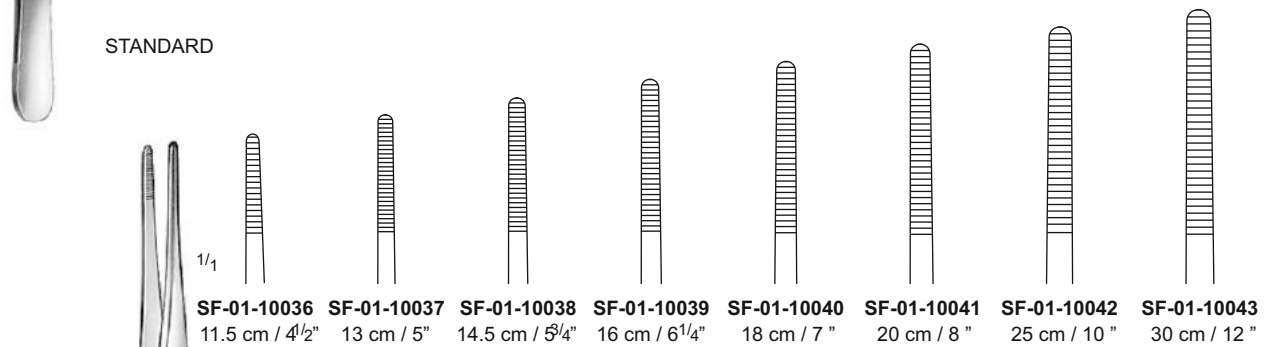
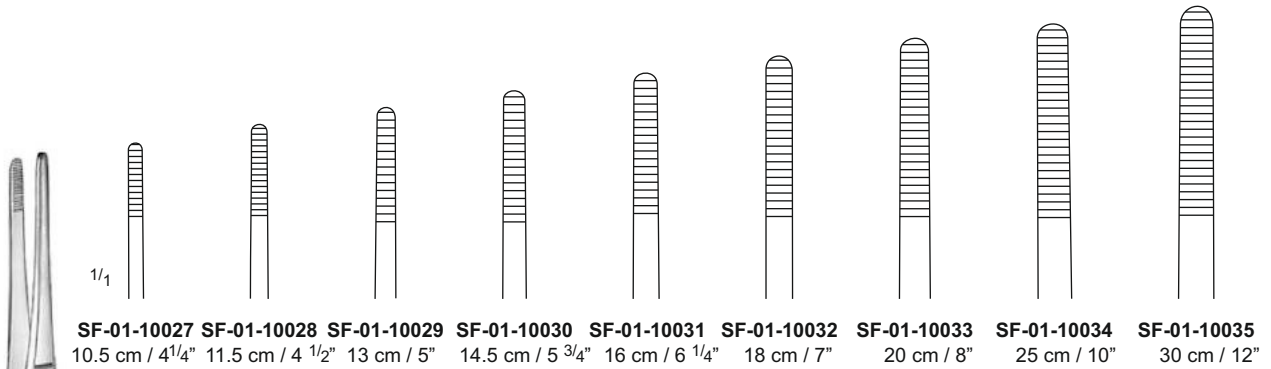

STANDARD
Narrow

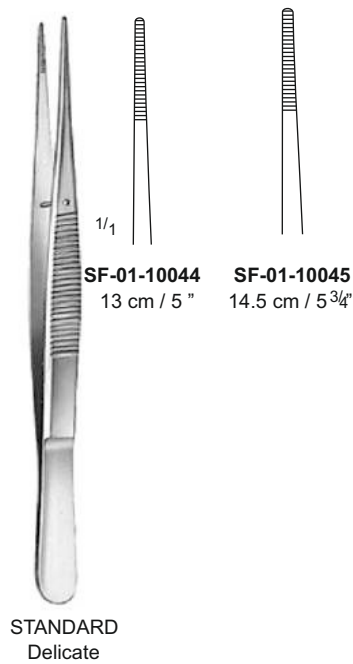

STANDARD
Delicate

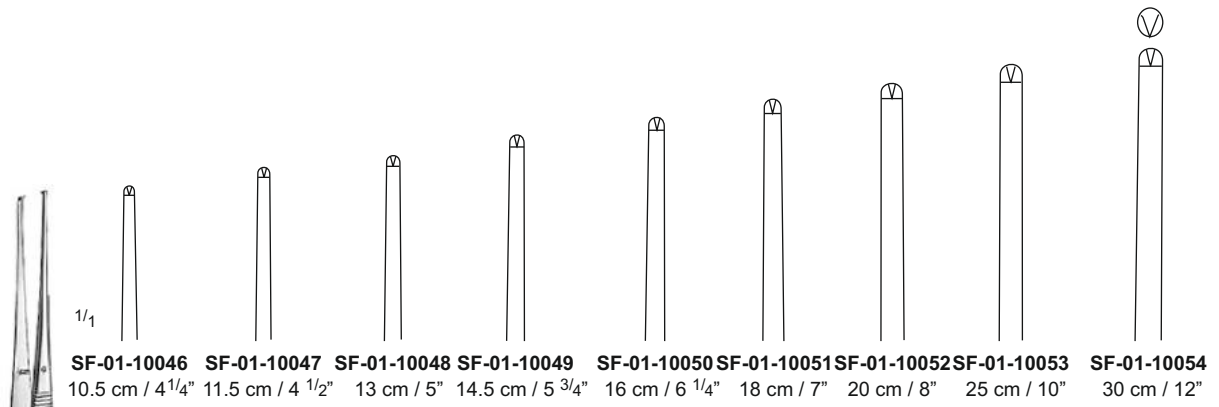

1 x 2 teeth

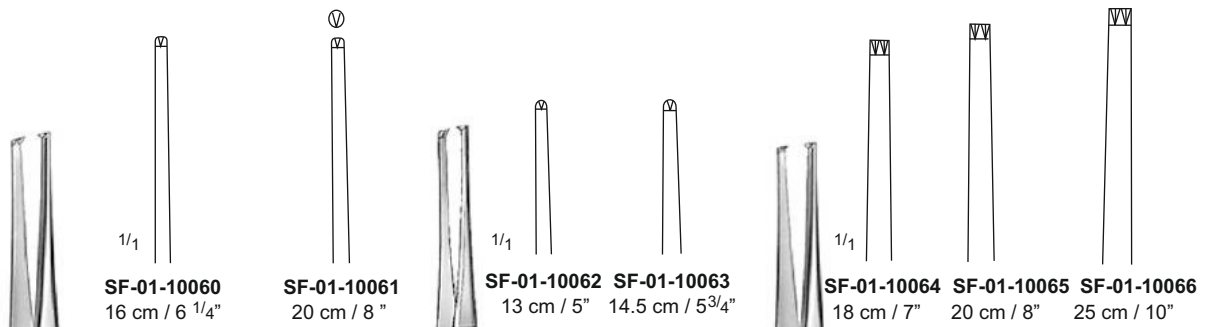

MEDIUM
1 X 2 teeth

DELICATE
1 X 2 teeth

2 x 3 teeth



1/1

SF-01-10067
14.5 cm / 5 3/4"



SF-01-10068
16 cm / 6 1/4"



1/1

SF-01-10069
13 cm / 5"



SF-01-10070
16 cm / 6 1/4"



1/1

LERCHE
SF-01-10071
15 cm / 6"
5 X 6 teeth



1/1

STONE
SF-01-10072
15 cm / 6"
5 x 6 teeth



1/1

ALDERKRUETZ



SF-01-10073
15 cm / 6"
2 x 3 teeth



SF-01-10074
20 cm / 8"
2 x 3 teeth



SF-01-10075
15 cm / 6"
4 x 5 teeth



SF-01-10076
20 cm / 8"
4 x 5 teeth



SF-01-10077
25 cm / 10"
4 x 5 teeth

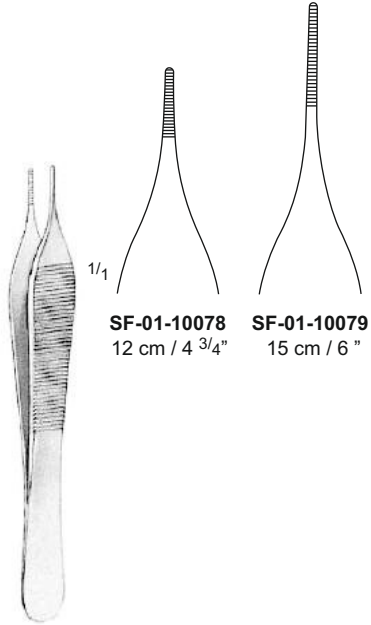

ADSON

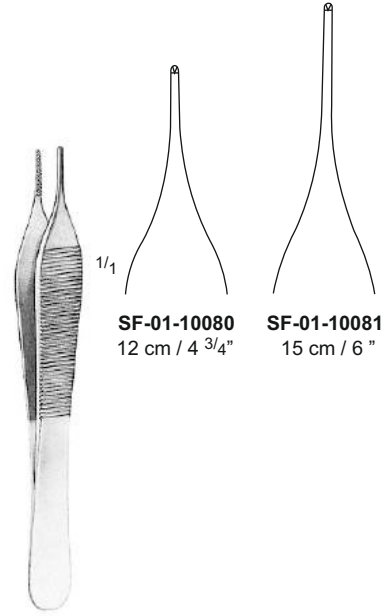

ADSON
1 x 2 teeth

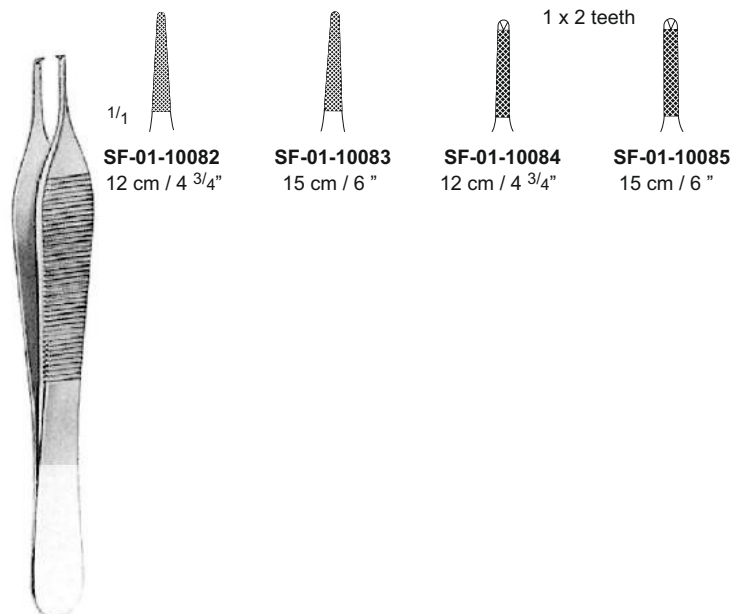

ADSON T/C

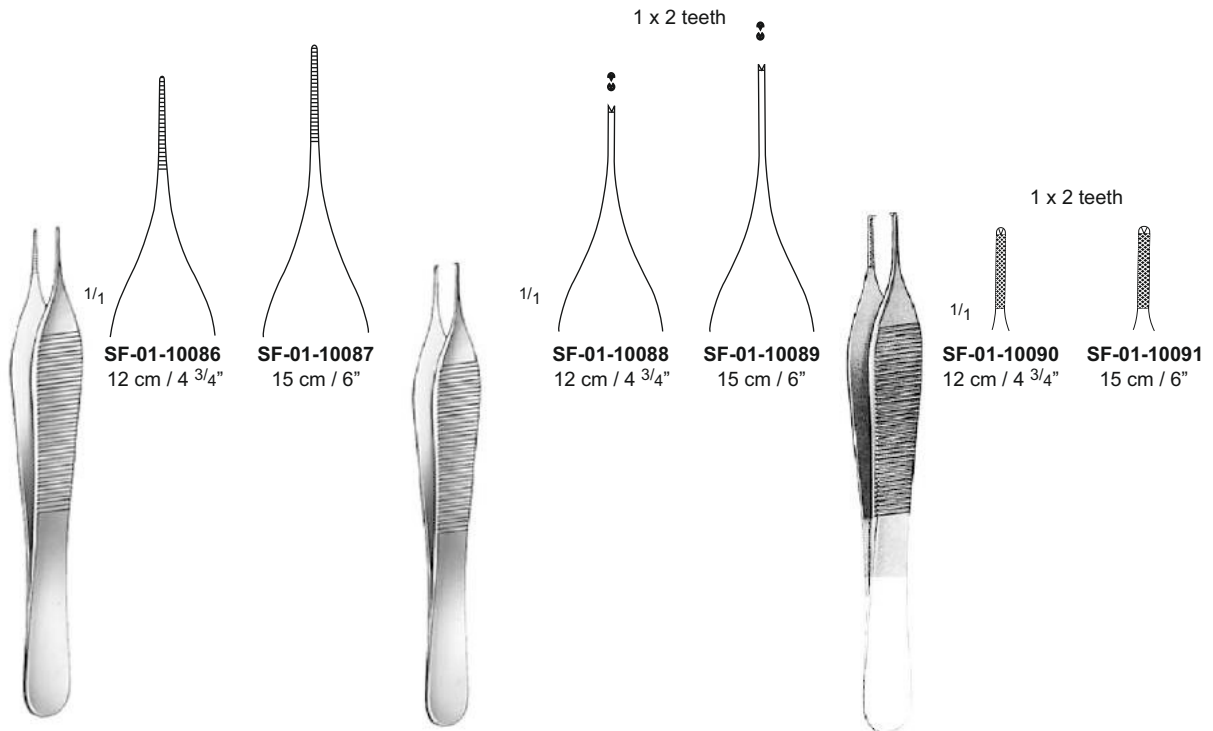

MICRO ADSON

MICRO ADSON

MICRO ADSON T/C

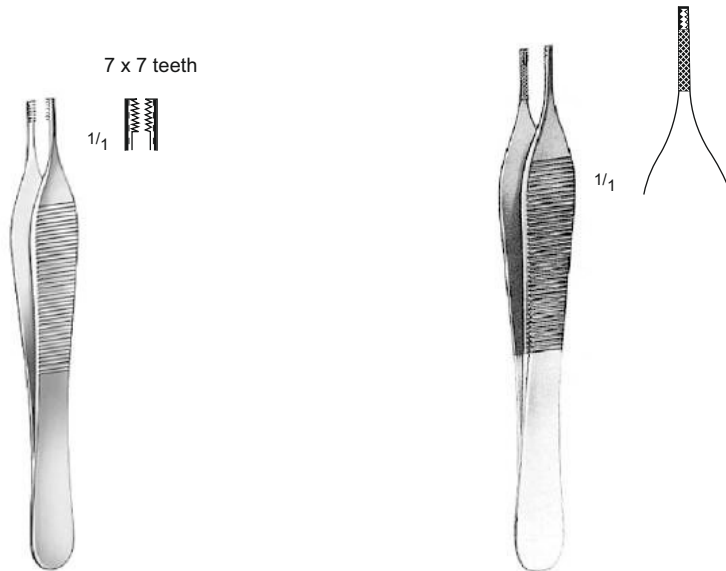

ADSON BROWN
SF-01-10092
12 cm / 4 3/4"

ADSON BROWN T/C
SF-01-10093
12 cm / 4 3/4"

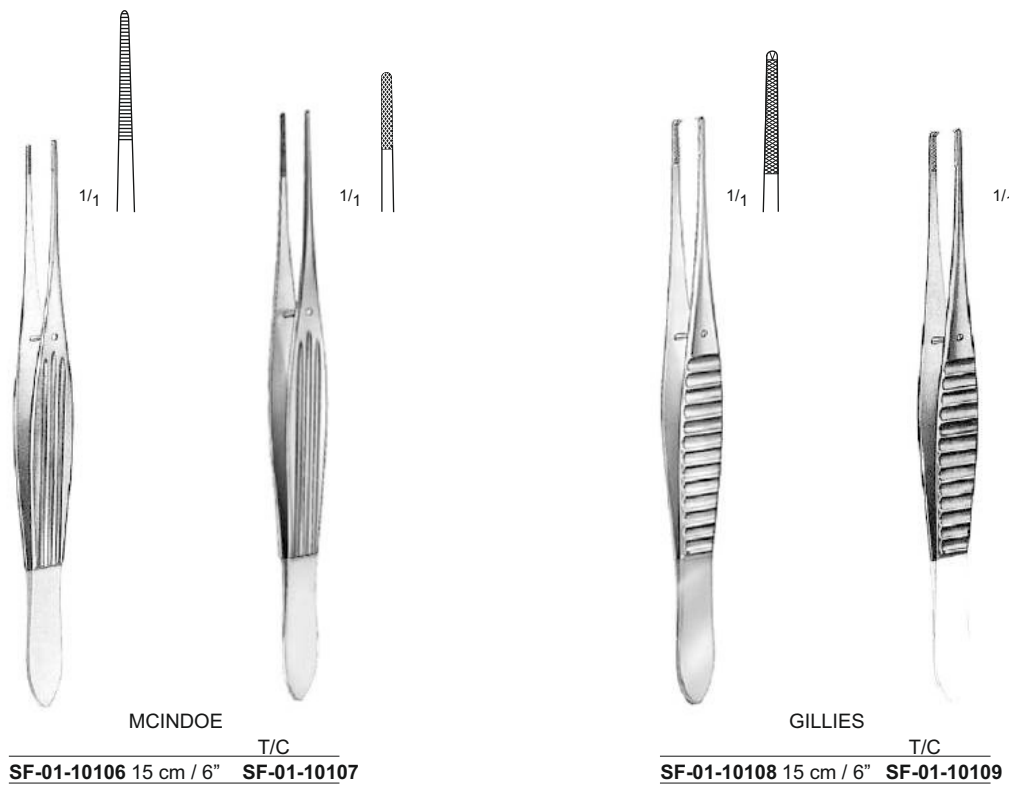
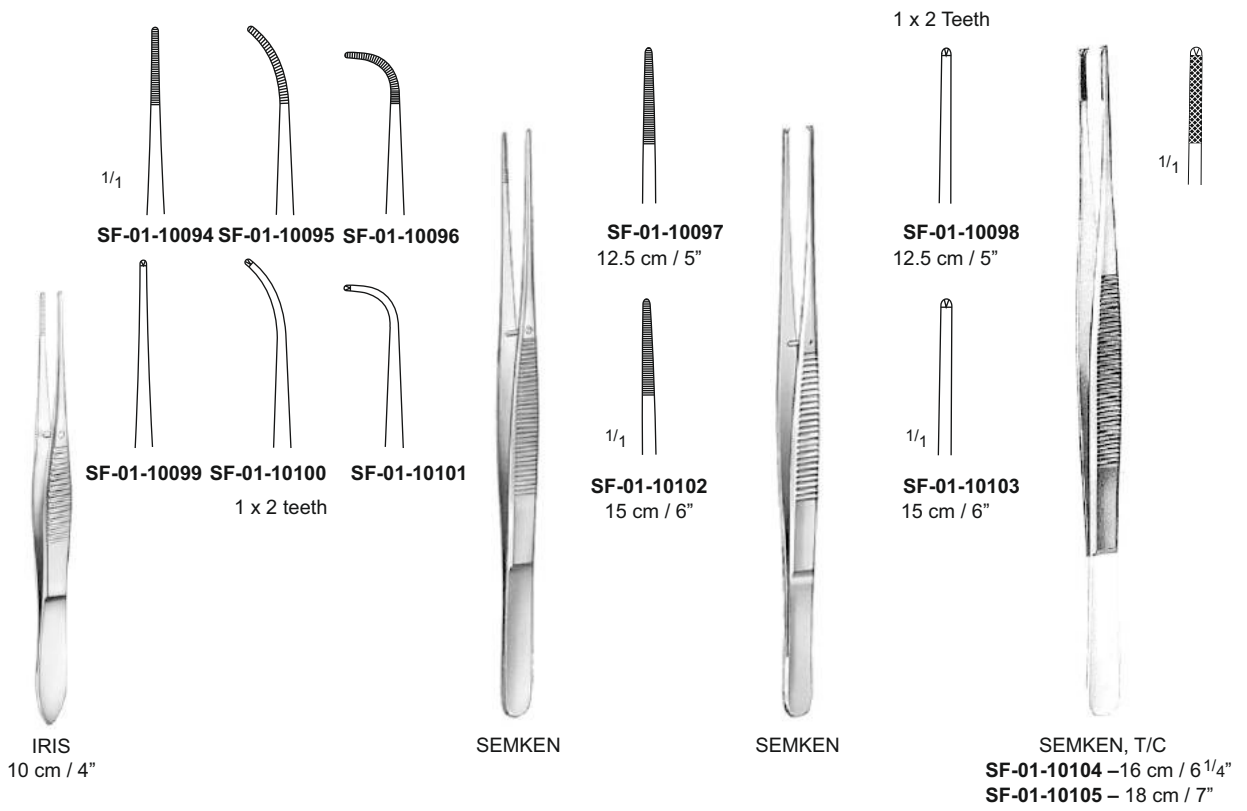

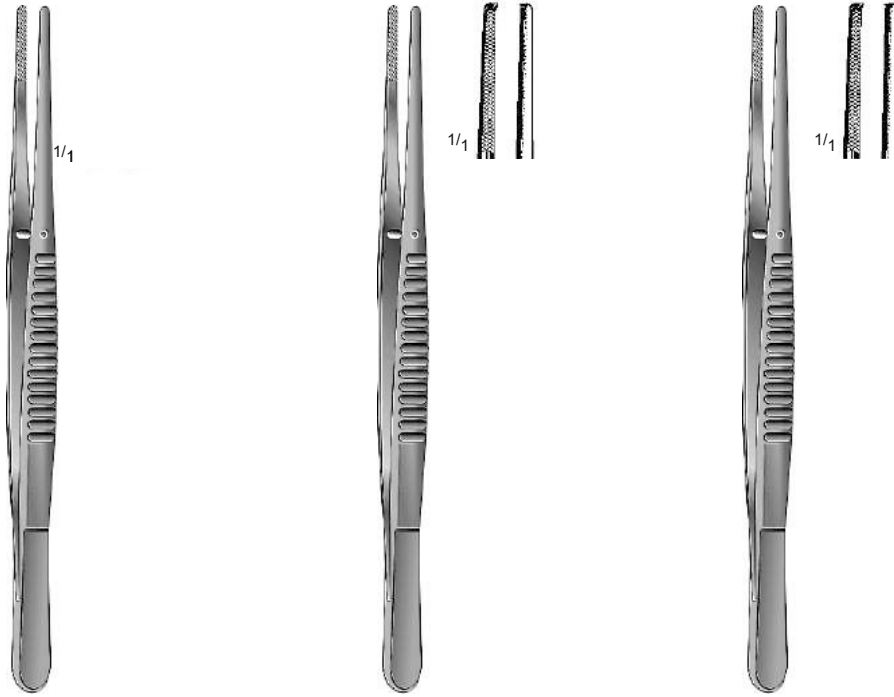

WAUGH

		1 x 2 teeth	T/C
15 cm / 6 "	SF-01-10110	SF-01-10111	SF-01-10112
20 cm / 8 "	SF-01-10113	SF-01-10114	SF-01-10115

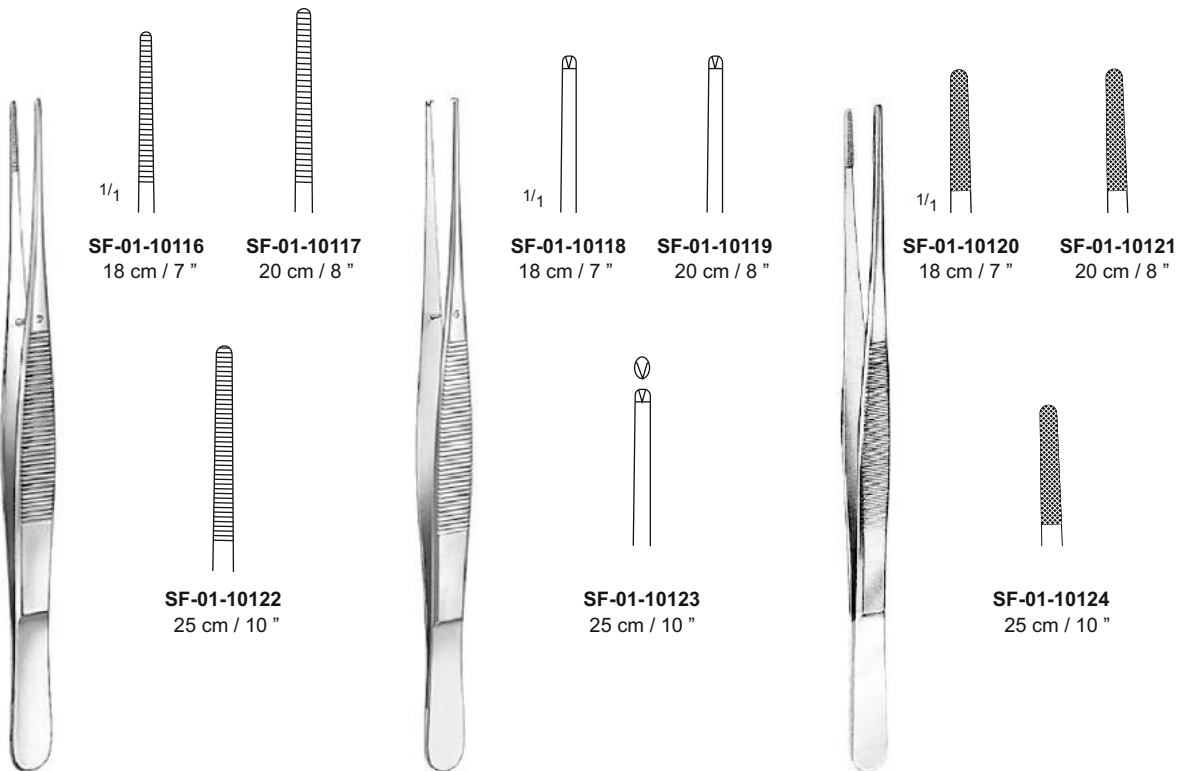

POTT SMITH
05. 39.18 – 05. 39.25

POTT SMITH
05. 41.18 – 05. 41.25
1 x 2 teeth

POTT SMITH, T/C
05. 39.68 – 05. 39.75

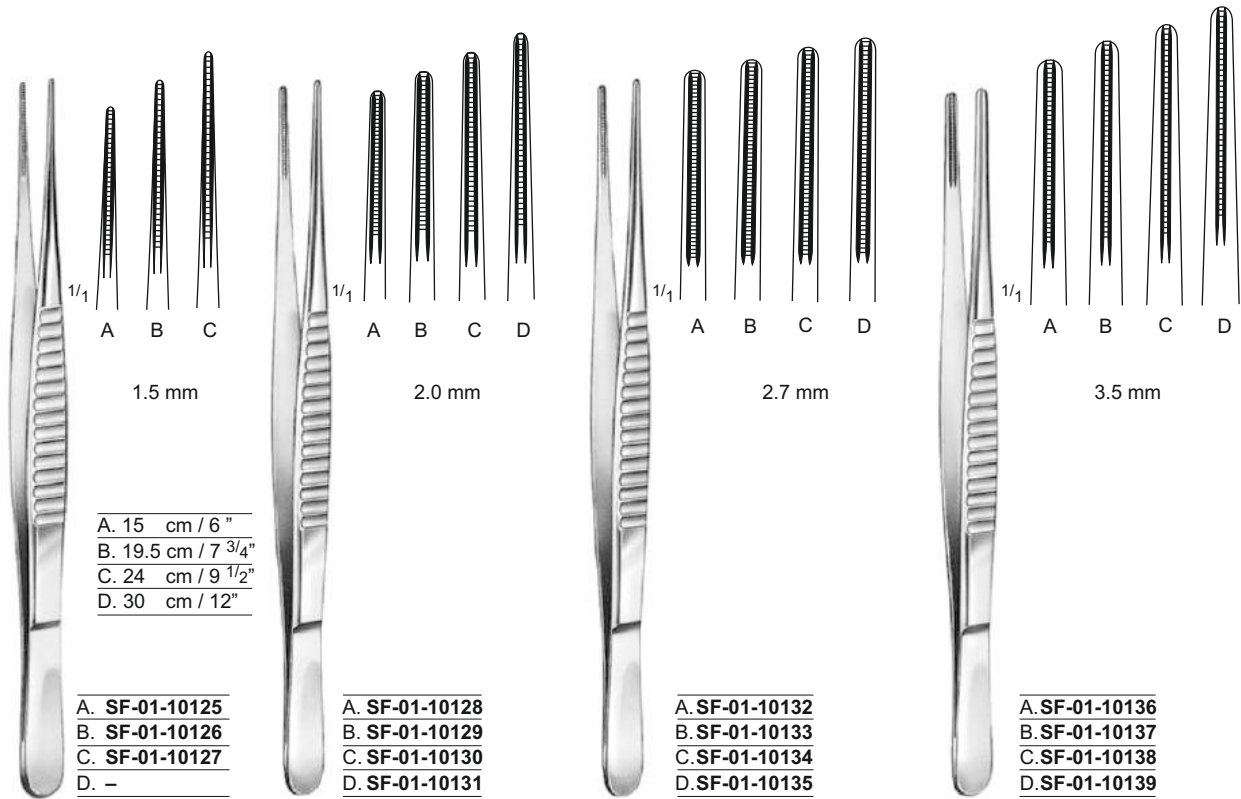

DE BACKEY

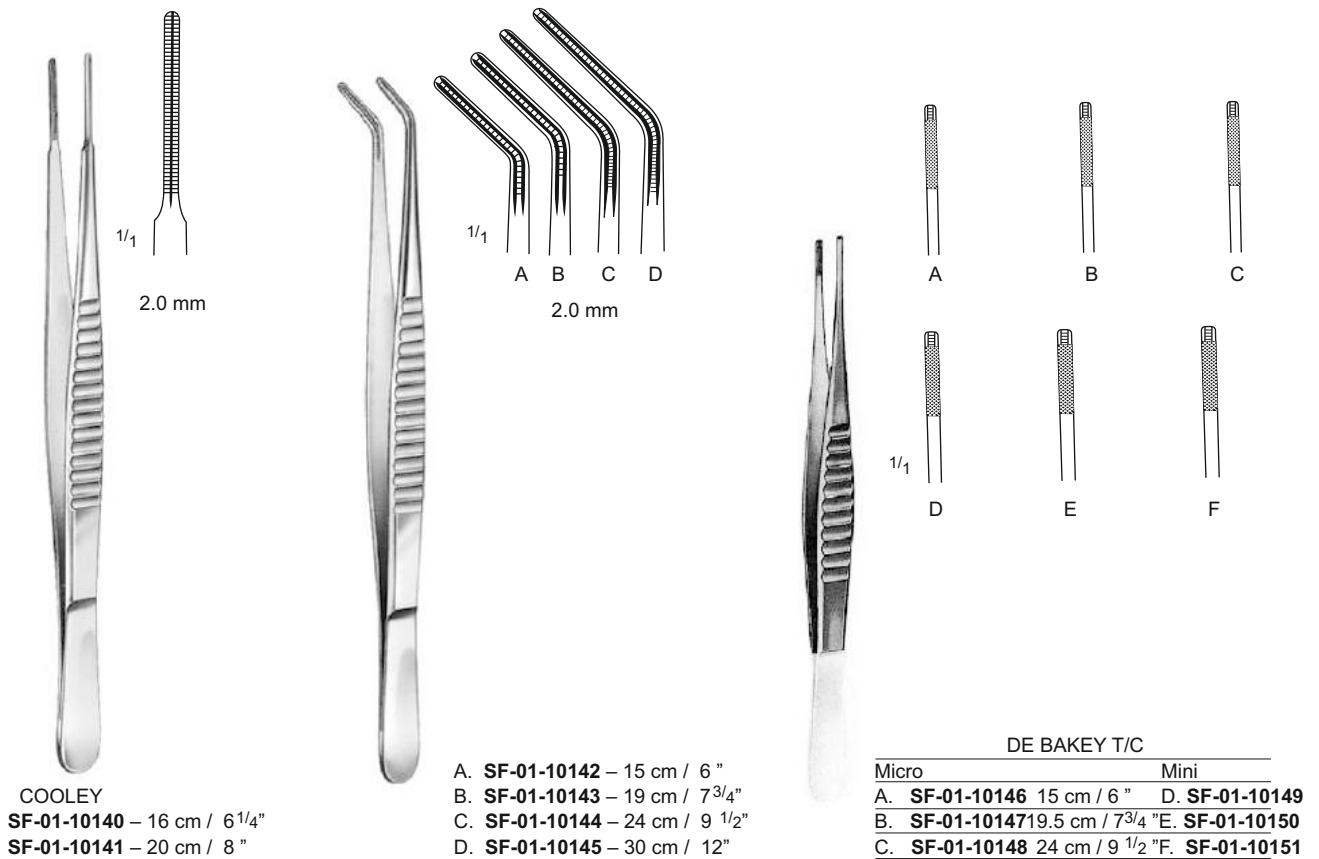

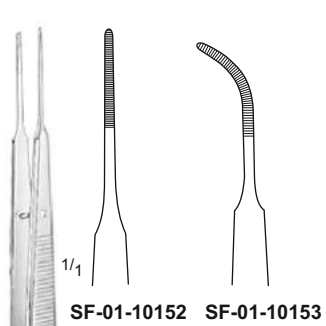

GEARLD
18 cm / 7"

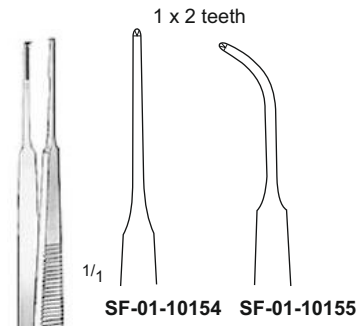

GEARLD
18 cm / 7"

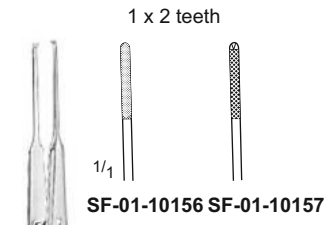

GEARLD, T/C
18 cm / 7"

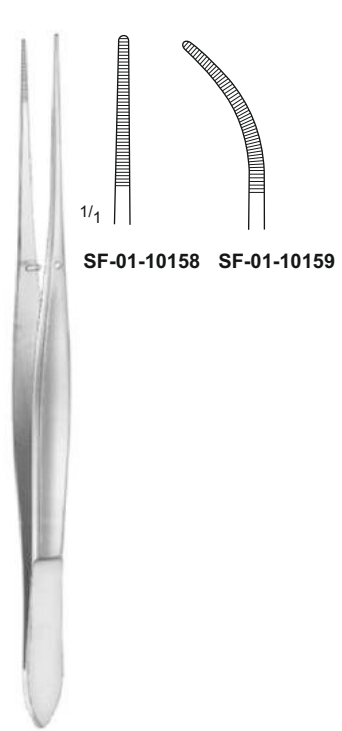

CUSHING
17.5 cm / 7"



CUSHING
SF-01-10160
17.5 cm / 7"

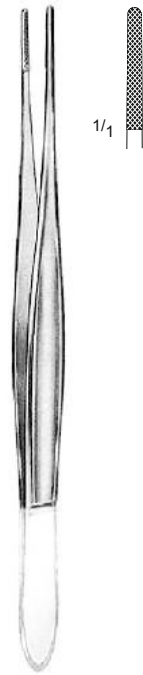

CUSHING T/C
SF-01-10161
17.5 cm / 7"

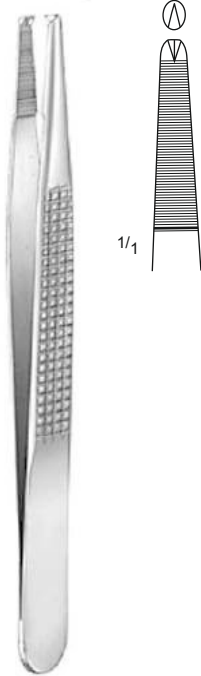

BONNEY
SF-01-10162
18 cm / 7"



BONNEY T/C
18 cm / 7"

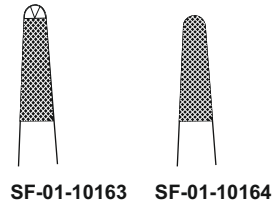

SF-01-10163 **SF-01-10164**



TAYLOR
SF-01-10165
17.5 cm / 7"



TAYLOR
SF-01-10166
17.5 cm / 7"



TAYLOR
SF-01-10167
17.5 cm / 7"



TAYLOR
SF-01-10168
17.5 cm / 7"



TAYLOR
SF-01-10169
17.5 cm / 7"



TAYLOR
SF-01-10170
17.5 cm / 7"



TAYLOR, T/C
SF-01-10171
17.5 cm / 7"

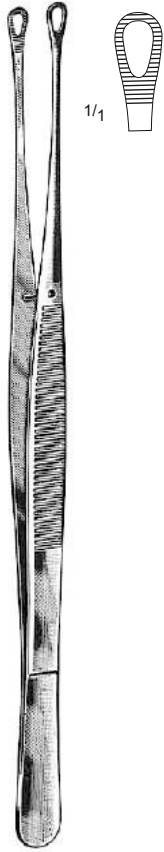

TUTTLE (SINGLEY)
SF-01-10172 – 18 cm / 7"
SF-01-10173 – 23 cm / 9"



RUSSIAN PATTERN

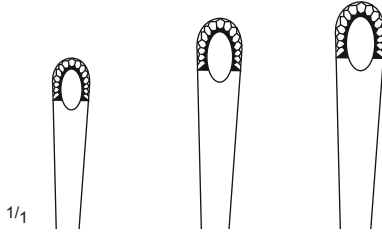

SF-01-10174 15 cm / 6" SF-01-10175 20 cm / 8" SF-01-10176 25 cm / 10"

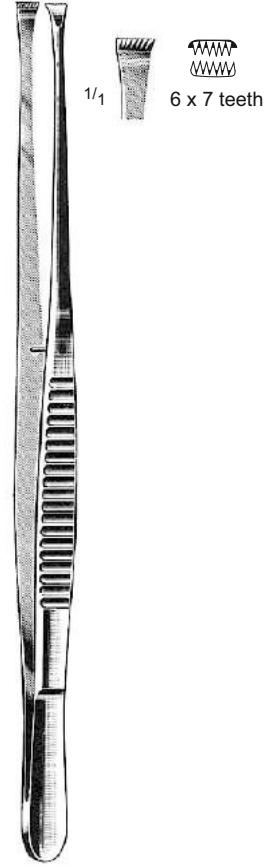

NELSON
SF-01-10177 – 15 cm / 6"
SF-01-10178 – 23 cm / 9"

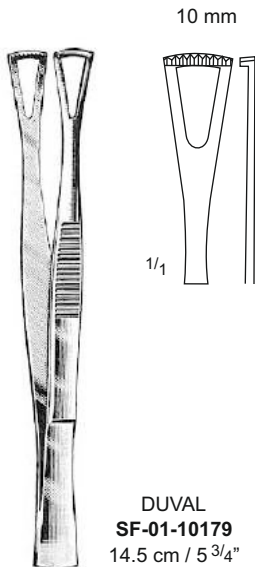

DUVAL
SF-01-10179
14.5 cm / 5 3/4"

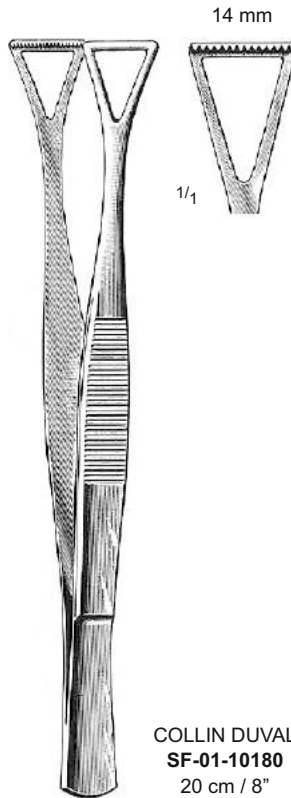

COLLIN DUVAL
SF-01-10180
20 cm / 8"

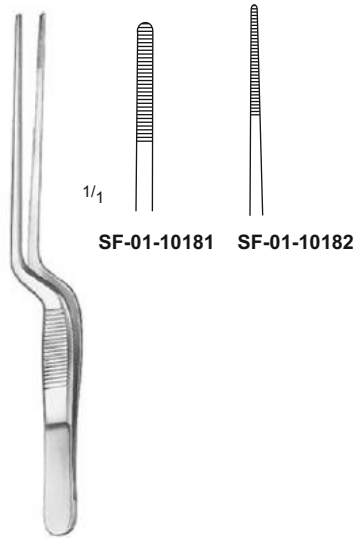

1/1

SF-01-10181 SF-01-10182

LUCAE
14 cm / 5 1/2"

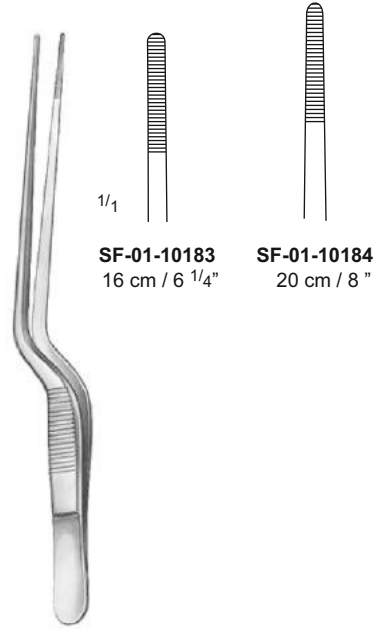

1/1

SF-01-10183 SF-01-10184
16 cm / 6 1/4" 20 cm / 8"

GRUENWALD (JANSEN)

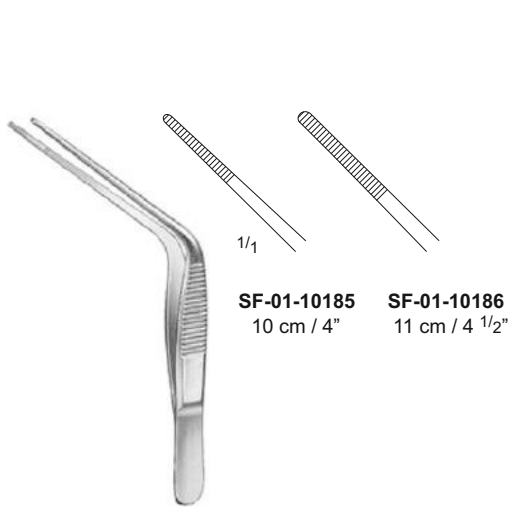

1/1

SF-01-10185 SF-01-10186
10 cm / 4" 11 cm / 4 1/2"

TROELTSCH (WILDE)

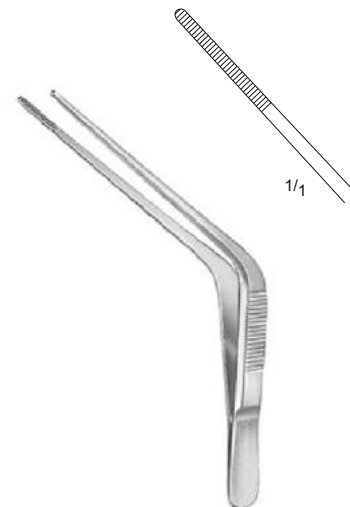

1/1

TROELTSCH (WILDE)
SF-01-10187
13 cm / 5"

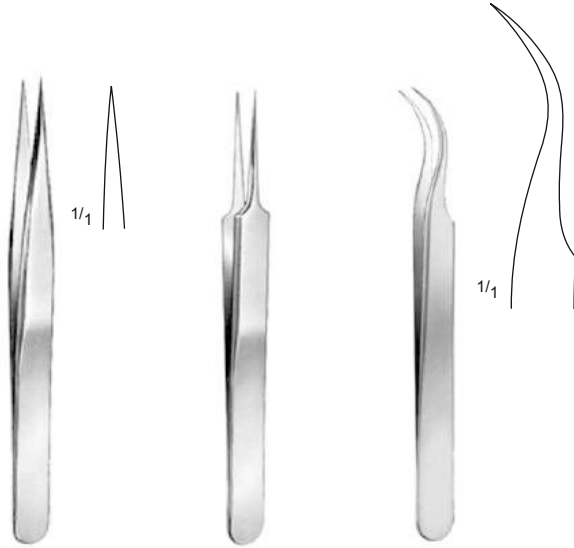

JEWELLER STYLE

SF-01-10188	SF-01-10189	SF-01-10190
No. 3	No. 5	No. 7
11.5 cm / 4 1/2"	11 cm / 4 1/4"	11.5 cm / 4 1/2"

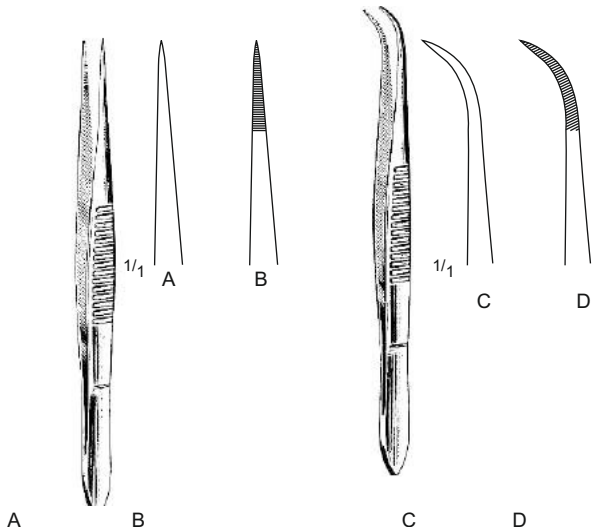

A	B	C	D
SF-01-10191	SF-01-10194	9 cm / 3 1/2"	SF-01-10197
SF-01-10192	SF-01-10195	11 cm / 4 1/2"	SF-01-10198
SF-01-10193	SF-01-10196	12.5cm / 5"	SF-01-10199
			SF-01-10201
			SF-01-10202

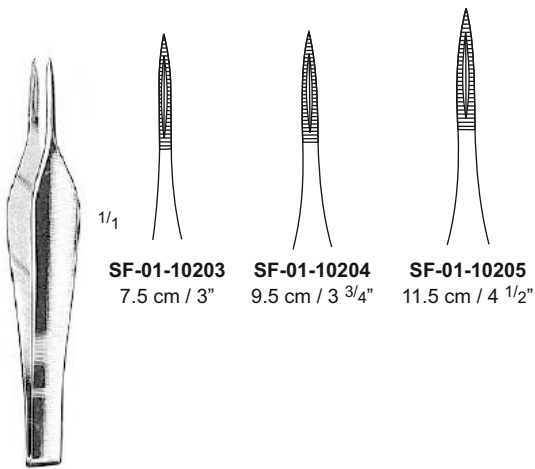

FEILCHENFELD

SF-01-10203	SF-01-10204	SF-01-10205
7.5 cm / 3"	9.5 cm / 3 3/4"	11.5 cm / 4 1/2"

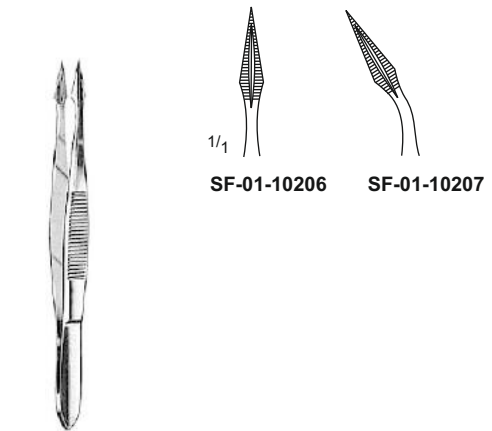

HUNTER
11 cm / 4 1/2"

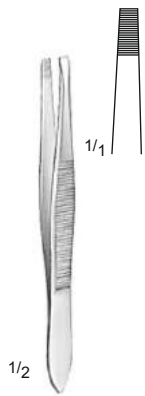

DOUGLAS
SF-01-10208
9 cm / 3 1/2"

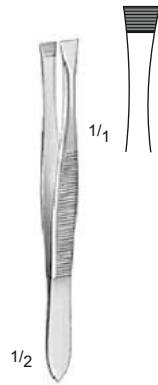

DOUGLAS
SF-01-10209
9 cm / 3 1/2"

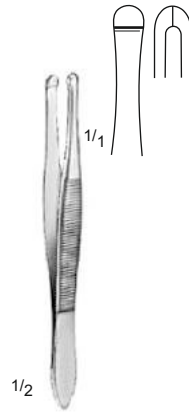

BEER
SF-01-10210
9 cm / 3 1/2"



BARRAQUER
SF-01-10211
10.5 cm / 4 1/4"



STEIGLITZ
14 cm / 5 1/2"

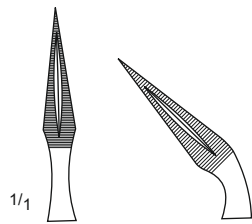

SF-01-10212

SF-01-10213



RALKS
14.5 cm / 5 1/2"

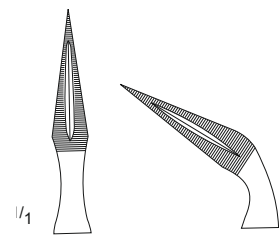

SF-01-10214

SF-01-10215

Delicate



BISHOP HARMON
SF-01-10216
8.3 cm / 3 1/4"

1 x 2 teeth

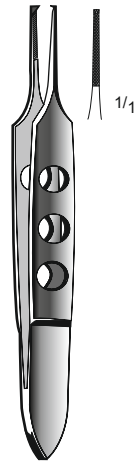

BISHOP HARMON
SF-01-10217
8.3 cm / 3 1/4"

Extremely Delicate



BISHOP HARMON
SF-01-10218
8.3 cm / 3 1/4"

1 x 2 teeth



BISHOP HARMON
SF-01-10219
8.3 cm / 3 1/4"



DESMARRES
9.5 cm / 3 3/4"

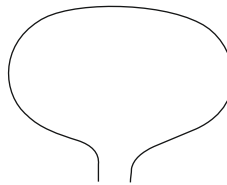

SF-01-10220

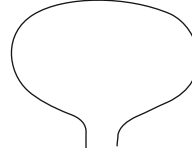

SF-01-10221



SF-01-10222

SPONGE FORCEPS



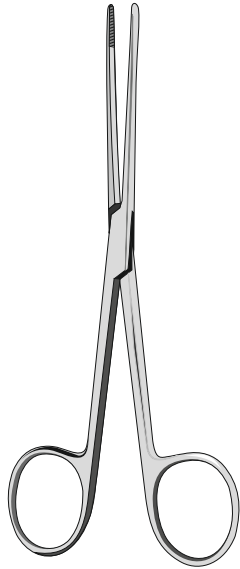

LISTER

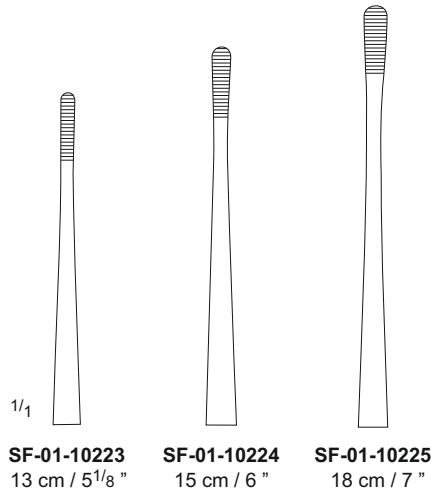

SF-01-10223
13 cm / 5 1/8"

SF-01-10224
15 cm / 6"

SF-01-10225
18 cm / 7"

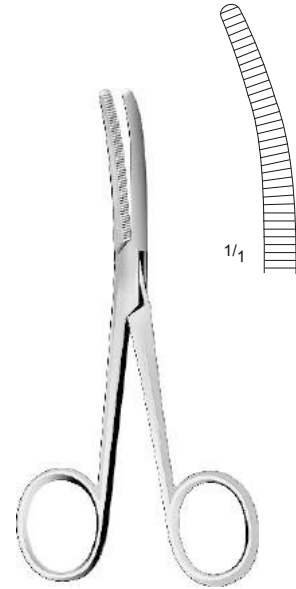

BRYANT
SF-01-10226
13 cm / 5"



GROSS MAIER

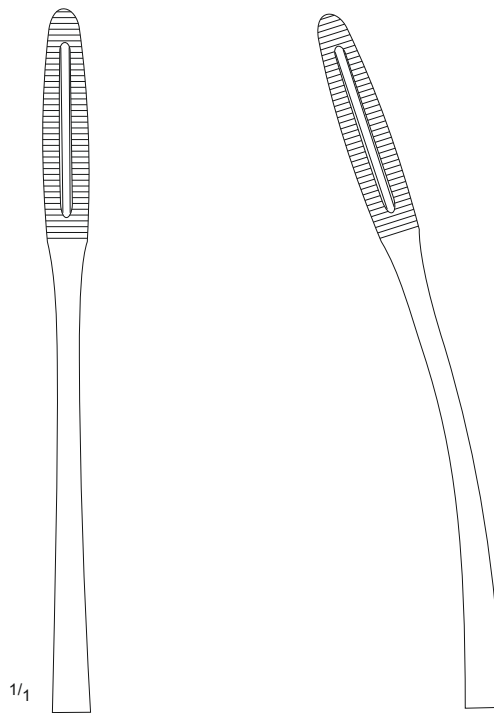

1/1

SF-01-10227	20 cm / 8"	SF-01-10230
SF-01-10228	22 cm / 8 3/4"	SF-01-10231
SF-01-10229	26 cm / 10 1/4"	SF-01-10232

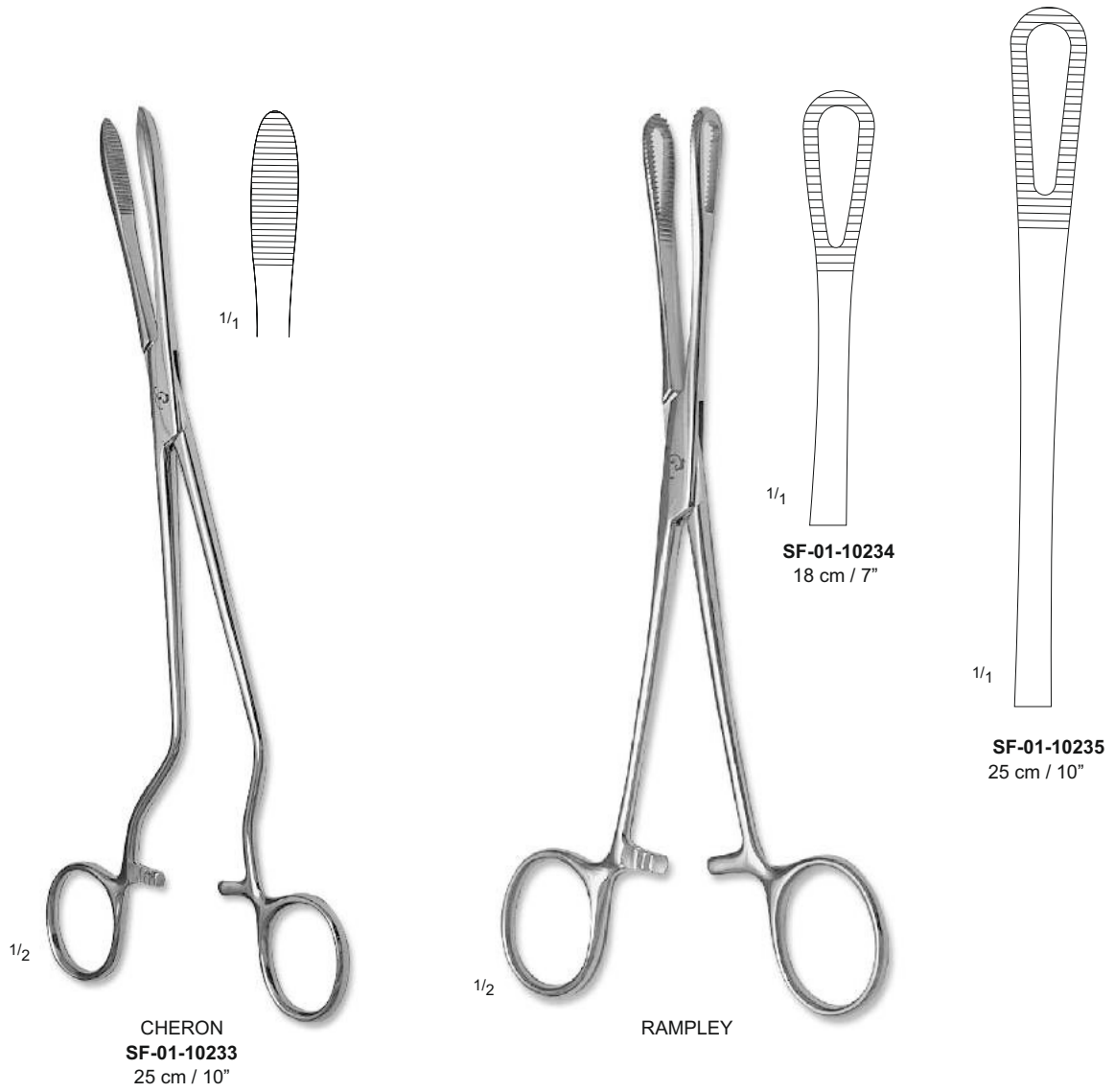

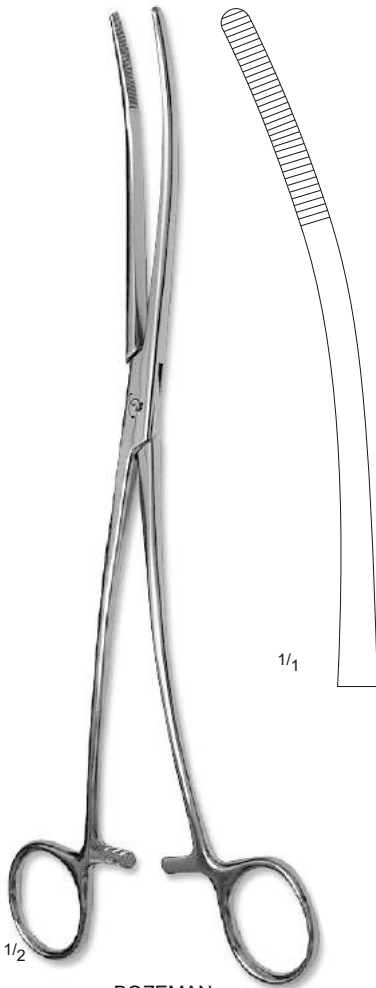

1/2

BOZEMAN
SF-01-10236
26 cm / 10 1/4"

1/1

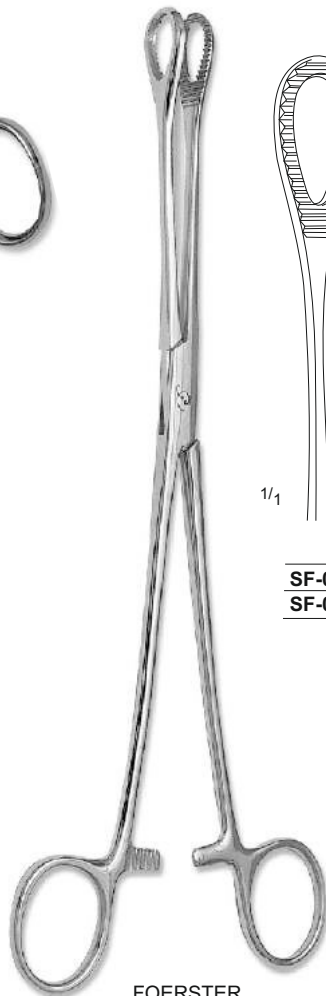

FOERSTER

1/1

SF-01-10239 - 18 cm / 7 1/8" - **SF-01-10241**
SF-01-10240 - 24 cm / 9 1/2" - **SF-01-10242**

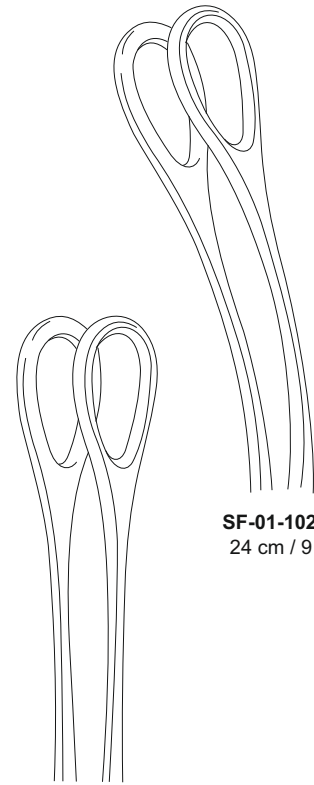

SF-01-10238
24 cm / 9 1/2"

SF-01-10237
24 cm / 9 1/2"

Hemostatic Forceps



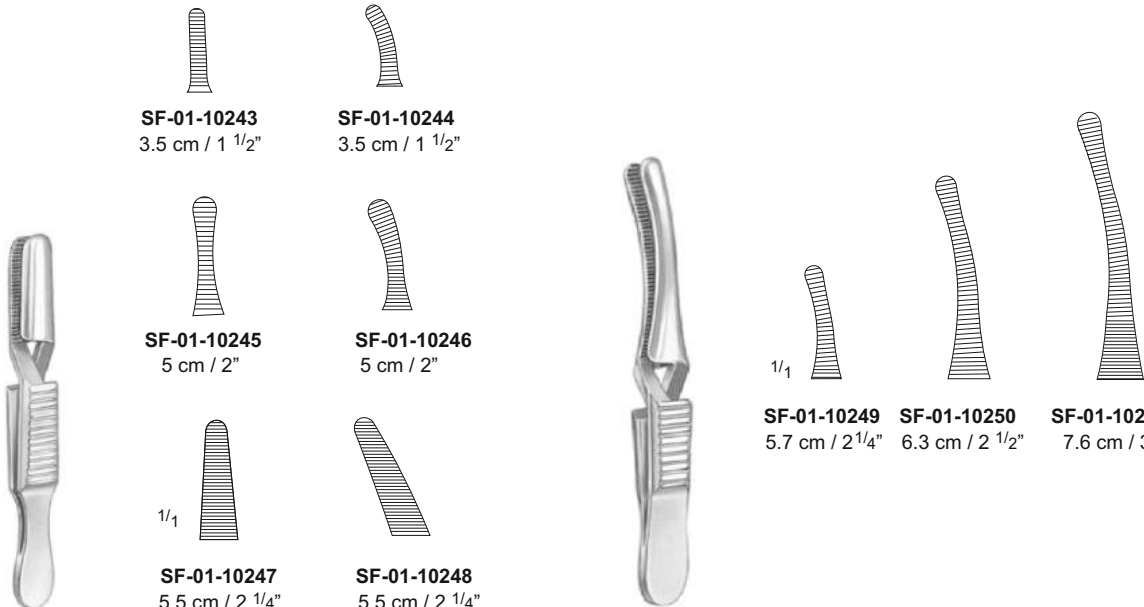

SF-01-10243
3.5 cm / 1 1/2"

SF-01-10244
3.5 cm / 1 1/2"

SF-01-10245
5 cm / 2"

SF-01-10246
5 cm / 2"

SF-01-10247
5.5 cm / 2 1/4"

SF-01-10248
5.5 cm / 2 1/4"

SF-01-10249
5.7 cm / 2 1/4"

SF-01-10250
6.3 cm / 2 1/2"

SF-01-10251
7.6 cm / 3"

DIEFFENBACH

JOHNS- HOPKINS

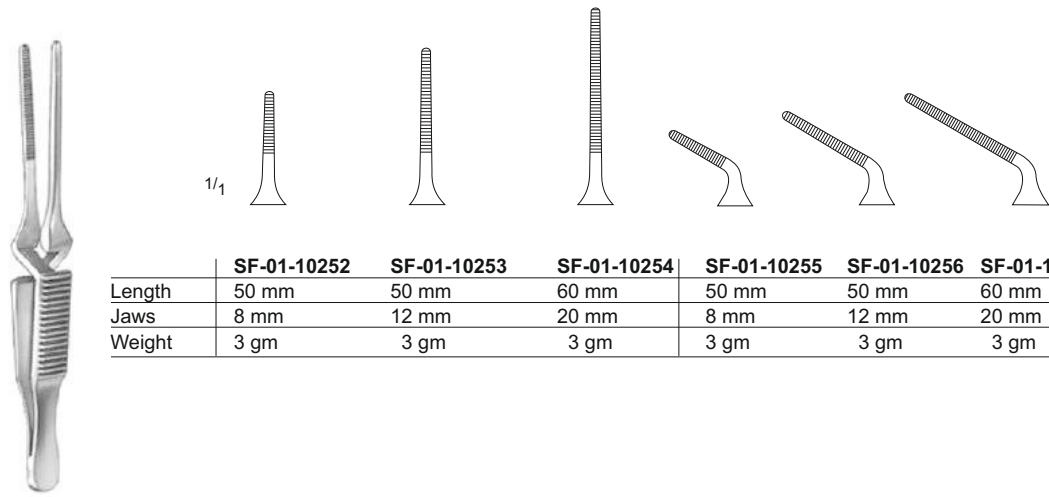

	SF-01-10252	SF-01-10253	SF-01-10254	SF-01-10255	SF-01-10256	SF-01-10257
Length	50 mm	50 mm	60 mm	50 mm	50 mm	60 mm
Jaws	8 mm	12 mm	20 mm	8 mm	12 mm	20 mm
Weight	3 gm	3 gm	3 gm	3 gm	3 gm	3 gm

DIETHRIC



HALSTEAD MOSQUITO



SF-01-10258
12.5 cm / 5"



SF-01-10259
14 cm / 5 1/2"



SF-01-10260
12.5 cm / 5"



SF-01-10261
14 cm / 5 1/2"



SF-01-10262
12.5 cm / 5"
1 x 2 teeth



SF-01-10263
14 cm / 5 1/2"
1 x 2 teeth



SF-01-10264
12.5 cm / 5"
1 x 2 teeth



SF-01-10265
14 cm / 5 1/2"
1 x 2 teeth



MICRO- HALSTEAD MOSQUITO



SF-01-10266
12.5 cm / 5"



SF-01-10267
12.5 cm / 5"



SF-01-10268
12.5 cm / 5"
1 x 2 teeth

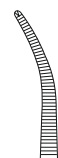

SF-01-10269
12.5 cm / 5"
1 x 2 teeth



CHAPUT
SF-01-10270
13 cm / 5"



TUFFIER
SF-01-10271
13 cm / 5"

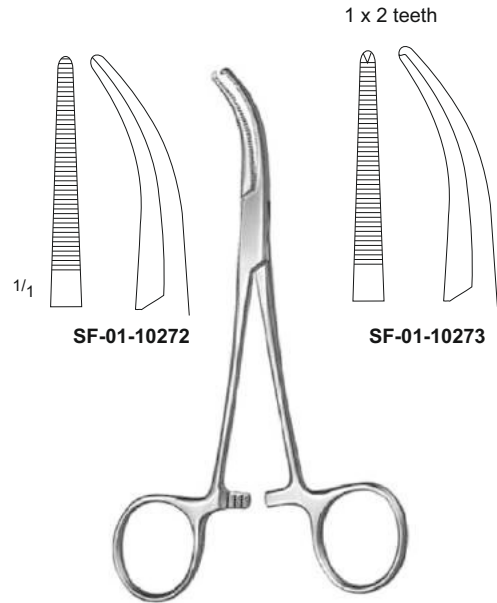

DANDY
14 cm / 5 1/2"

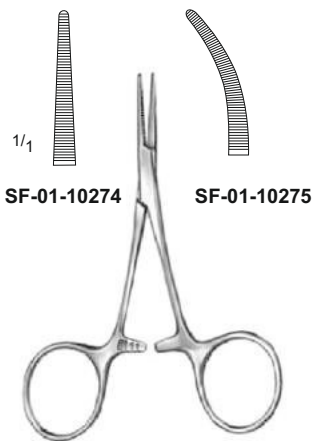

HARTMANN
(BABY MOSQUITO)
9 cm / 3 1/2"

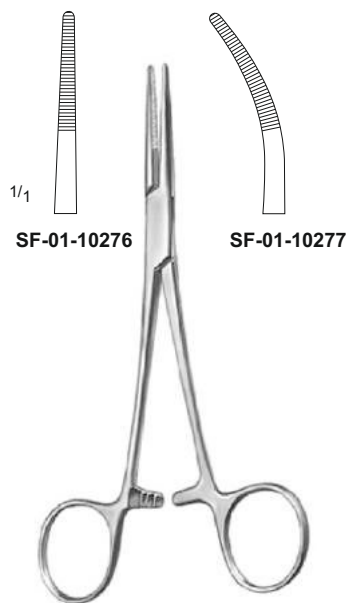

PROVIDENCE HOSPITAL
14 cm / 5 1/2"

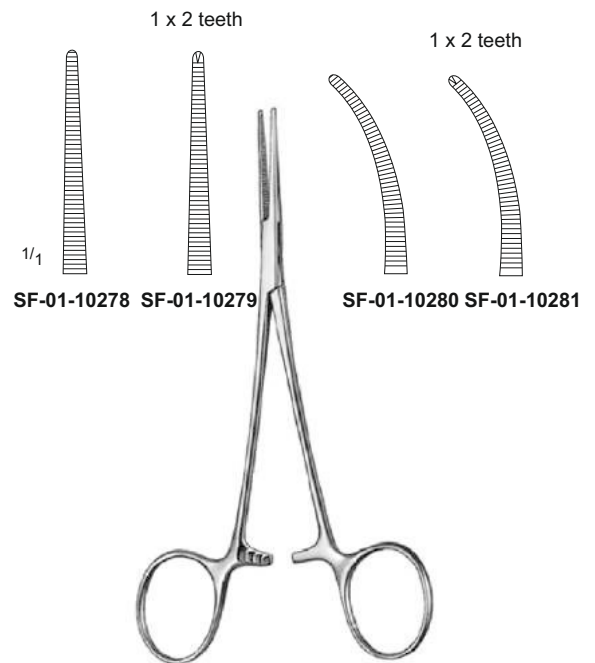

LERICHE
15 cm / 6"

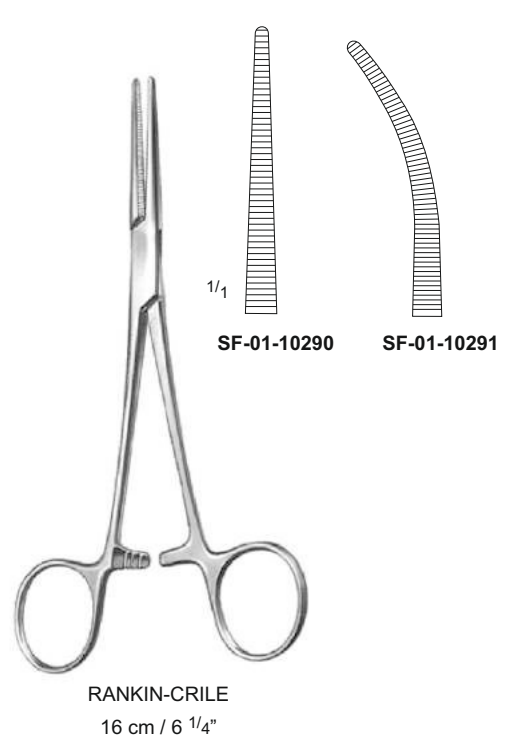
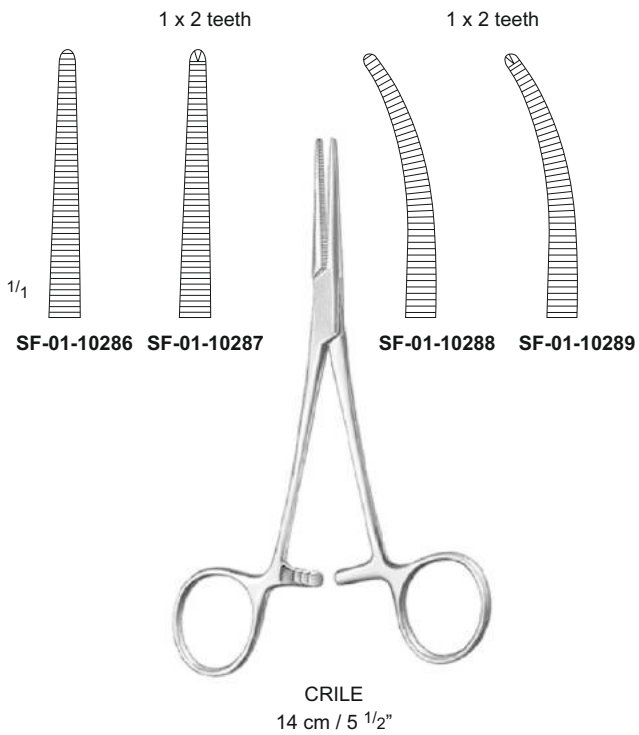
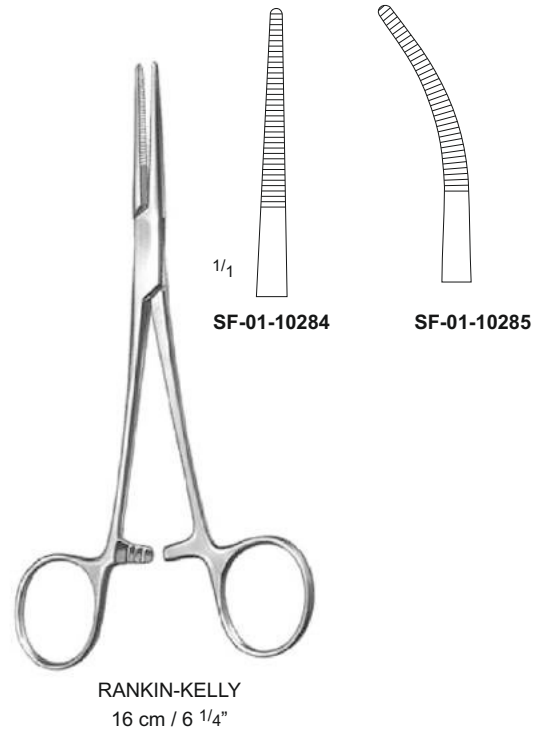
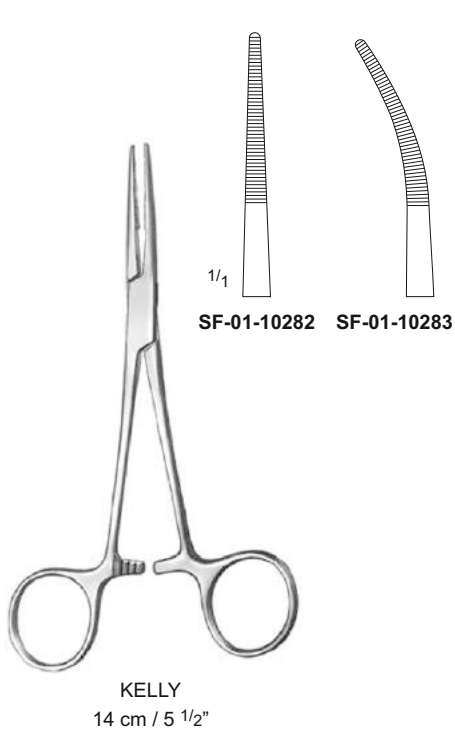

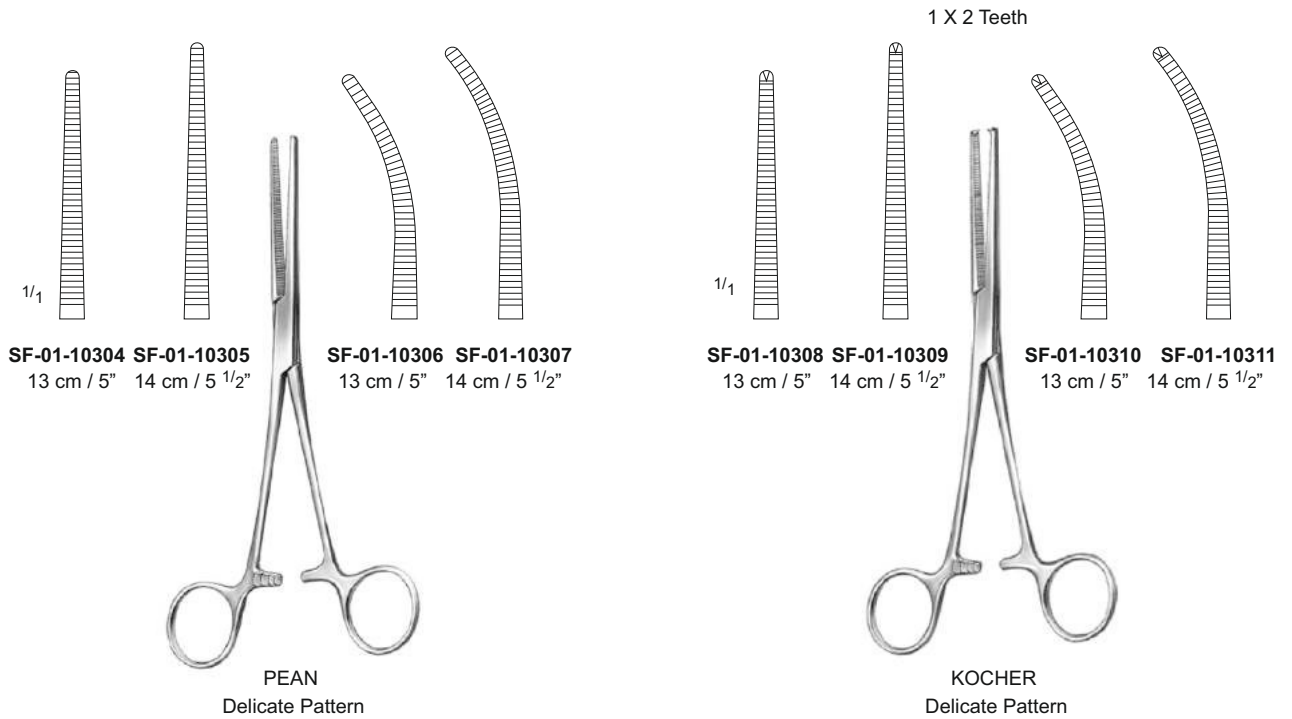
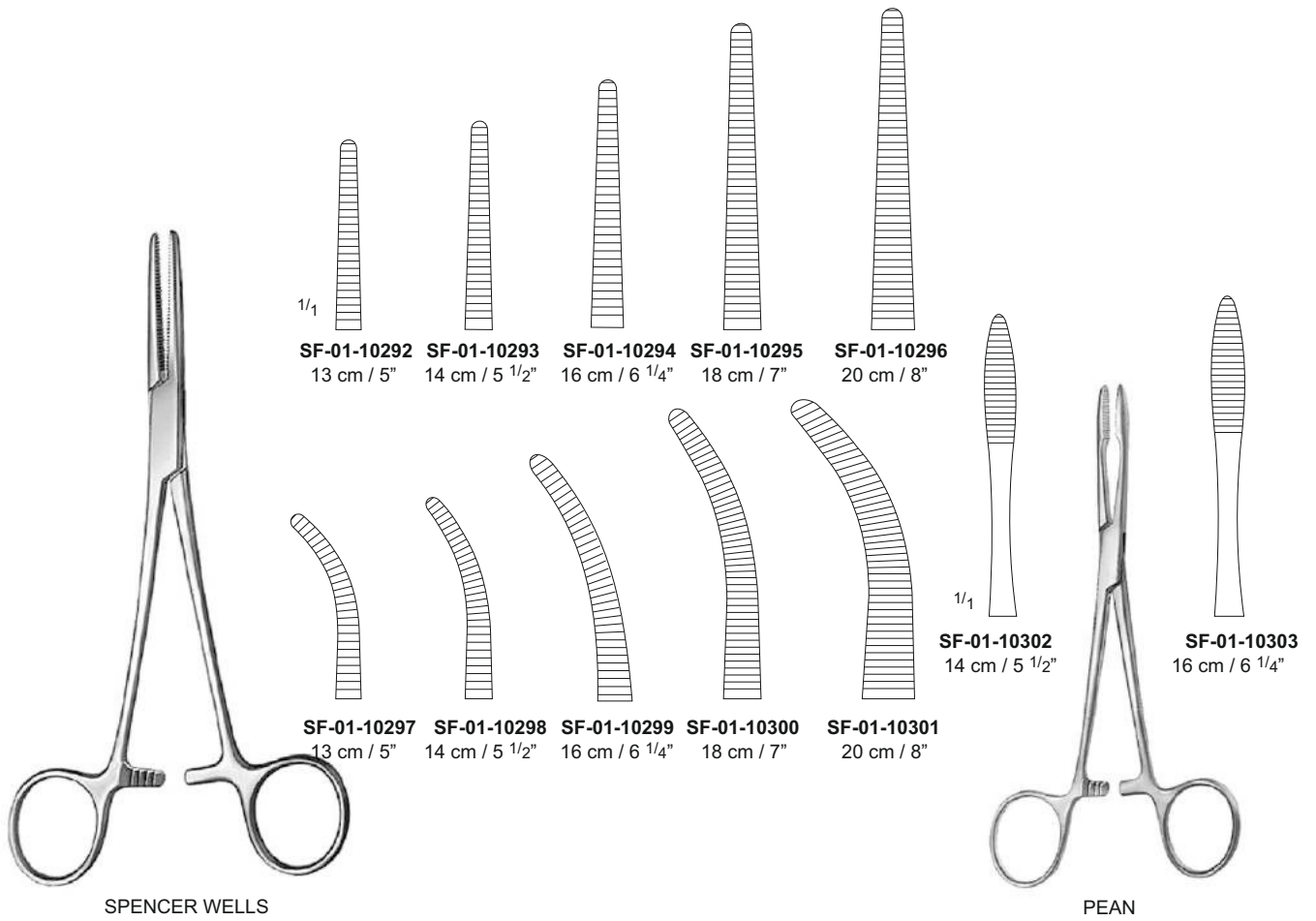

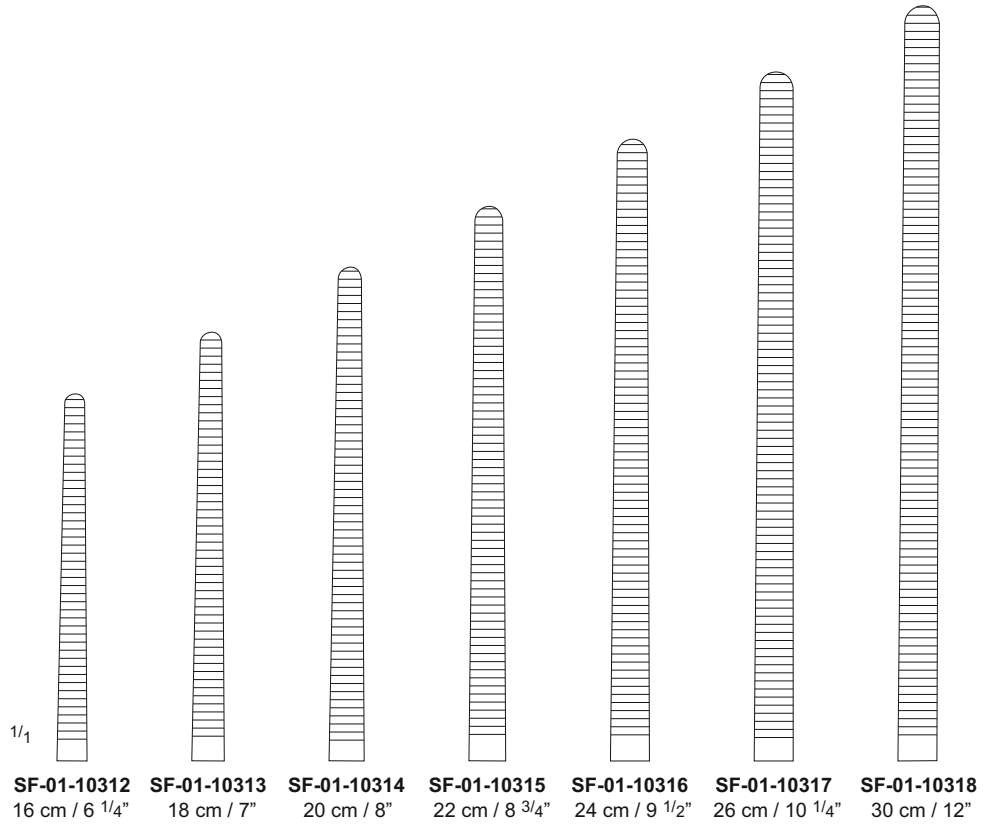

PEAN (ROCHESTER)

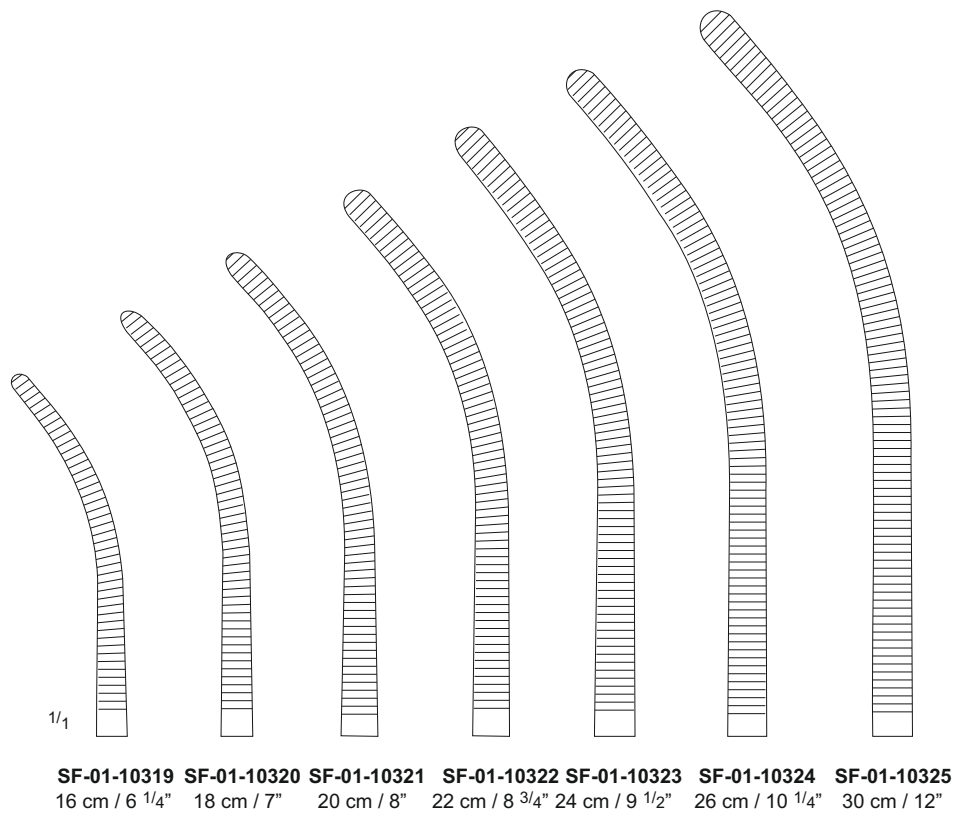

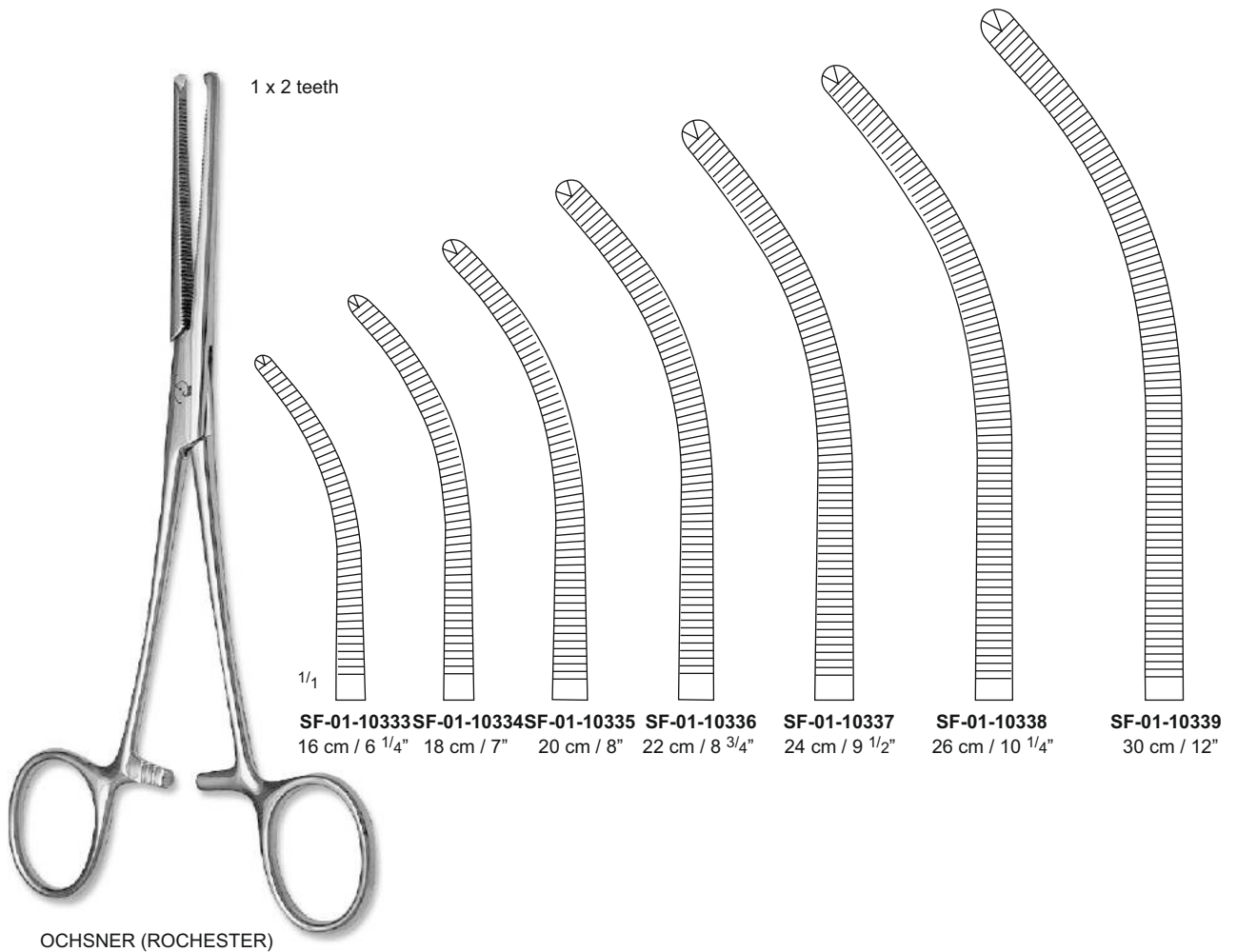
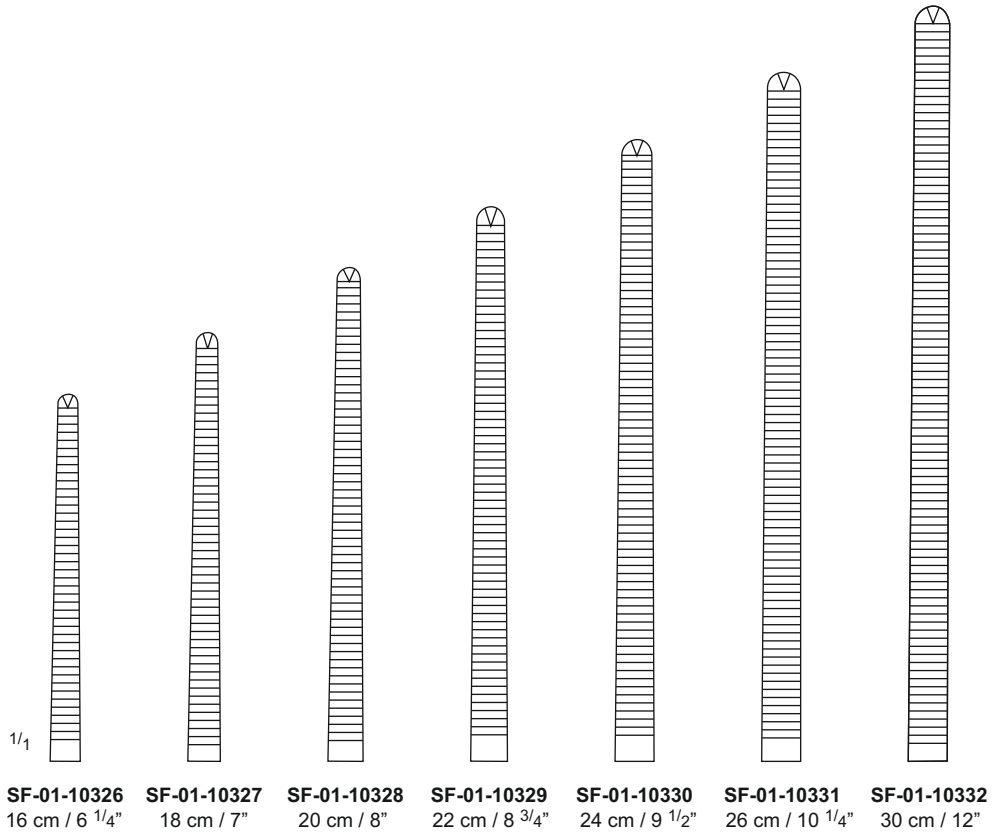



SF-01-10340
20 cm / 8"

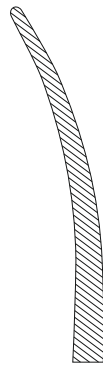

SF-01-10341



SF-01-10342
20 cm / 8"
1x2 teeth

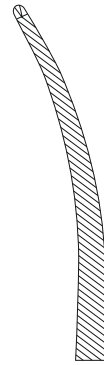

SF-01-10343



BENGOLEA

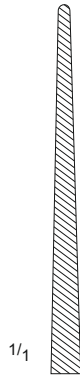

SF-01-10344
26 cm / 10 1/4"

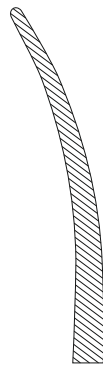

SF-01-10345



SF-01-10346
26 cm / 10 1/4"
1x2 teeth

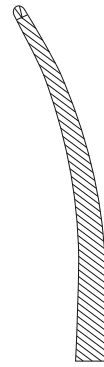

SF-01-10347

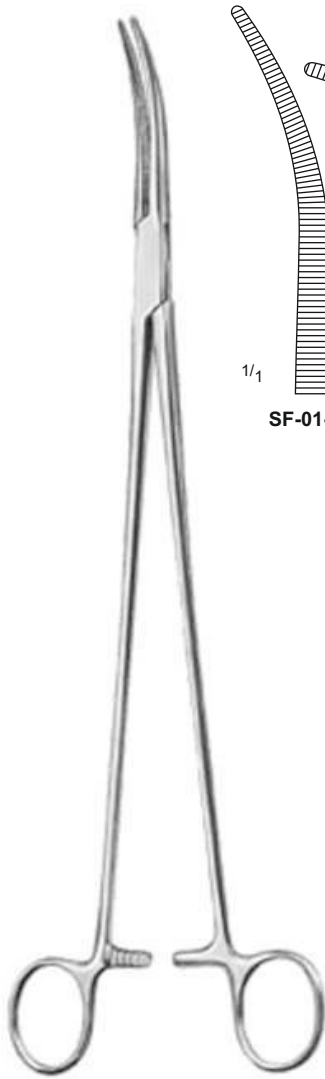

ZENKER
29.5 cm / 11 1/2"

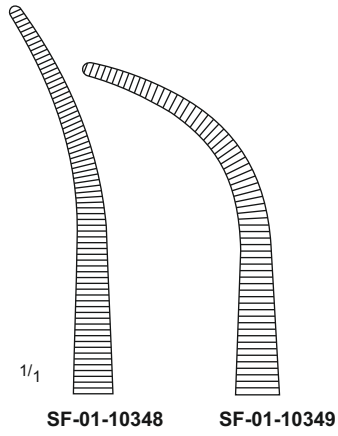

SF-01-10348

SF-01-10349

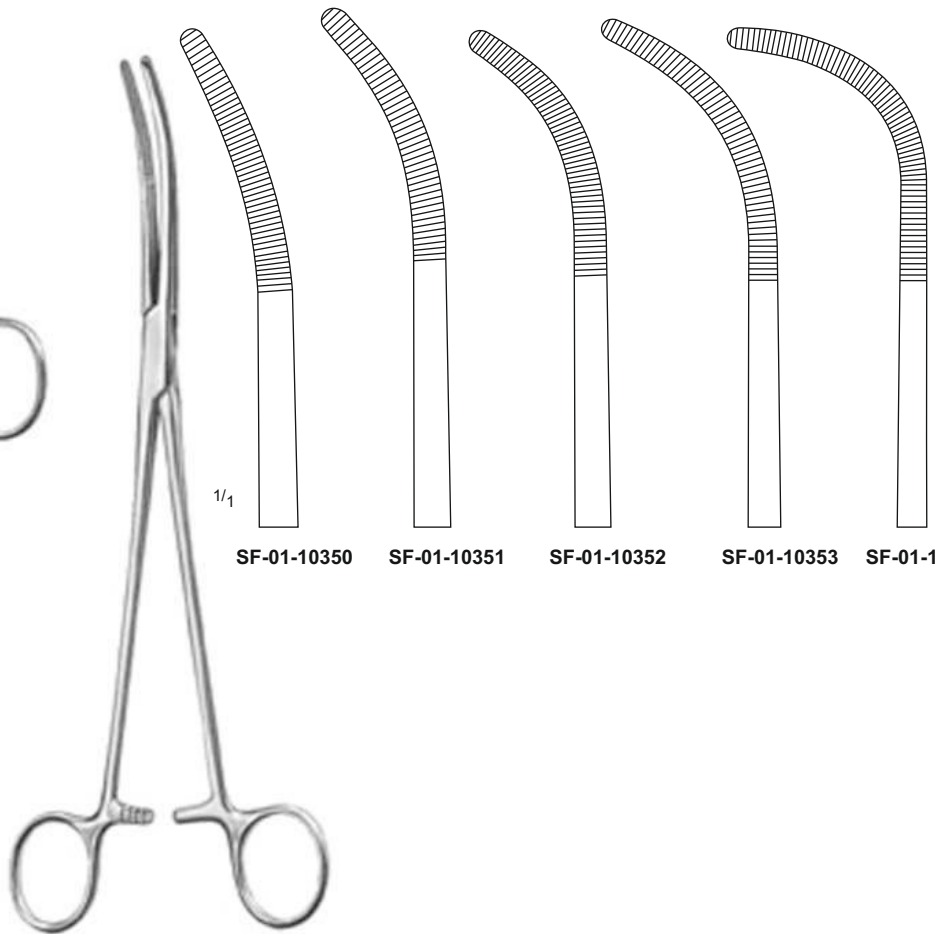

RUMEL
23 cm / 9"

SF-01-10350

SF-01-10351

SF-01-10352

SF-01-10353

SF-01-10354

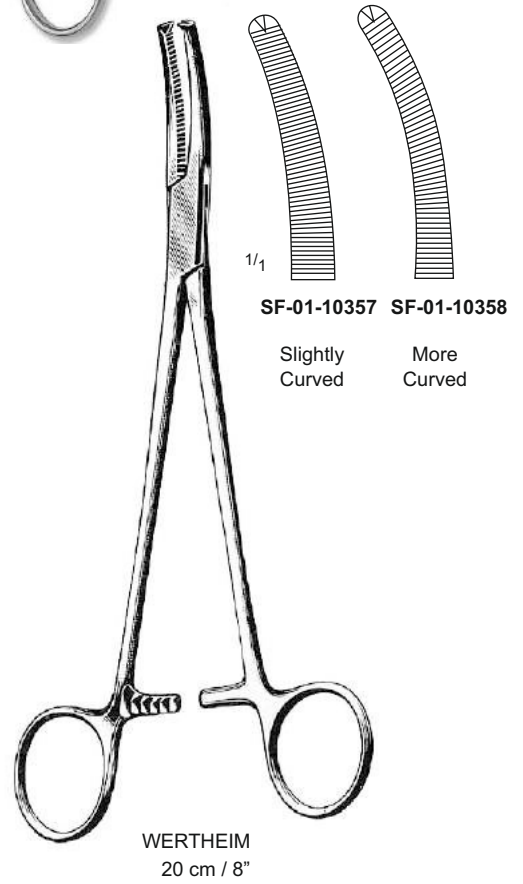
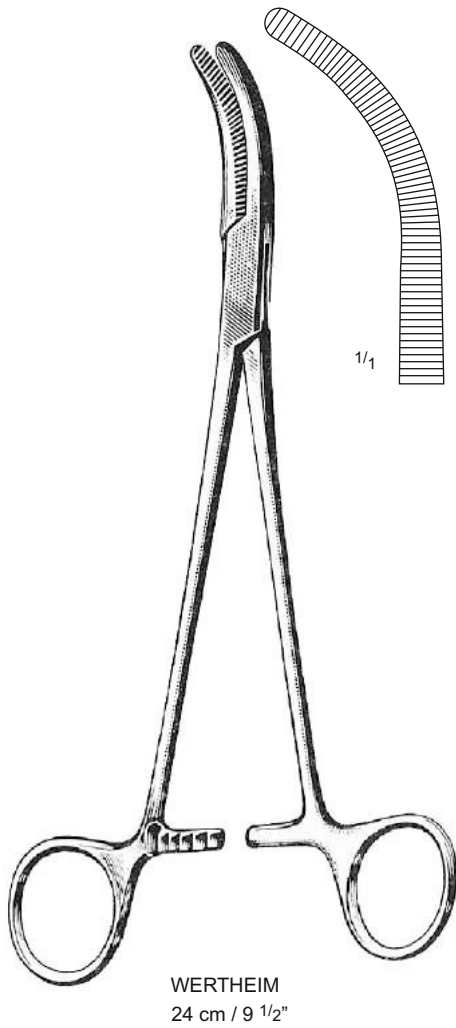
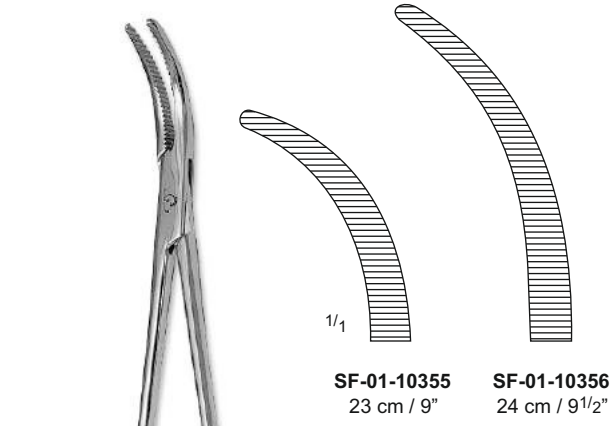

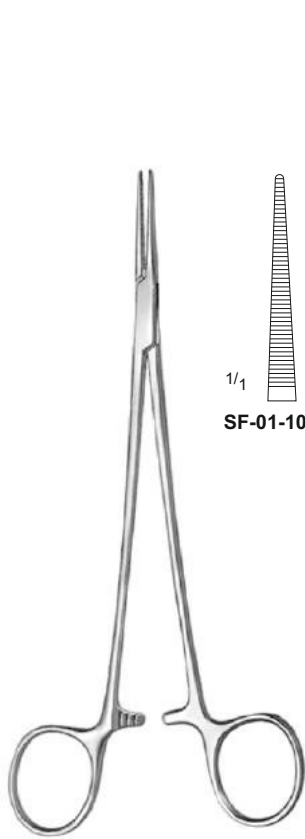

HALSTEAD (ADSON)
18 cm / 7"

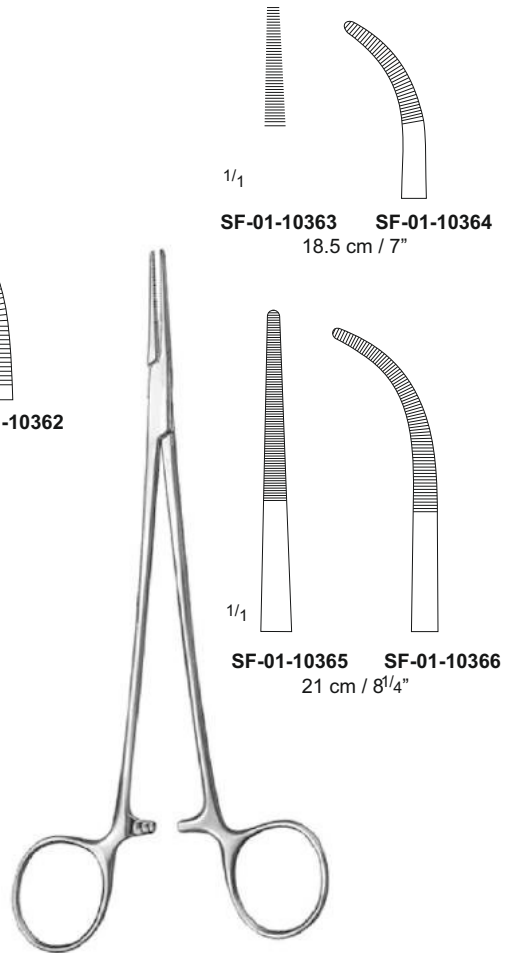
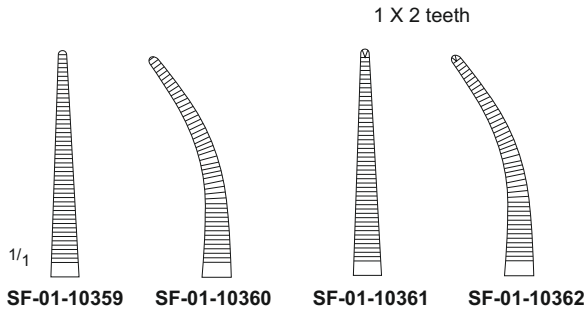

ADSON

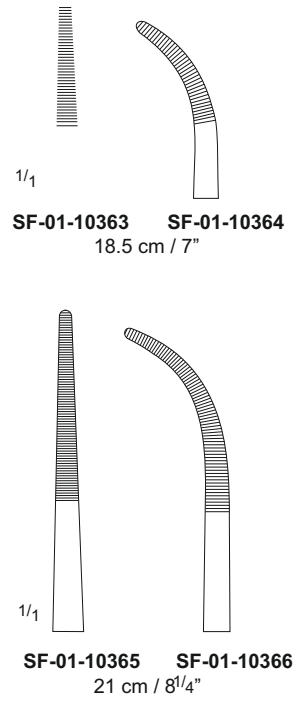

ROCHESTER CARMALT

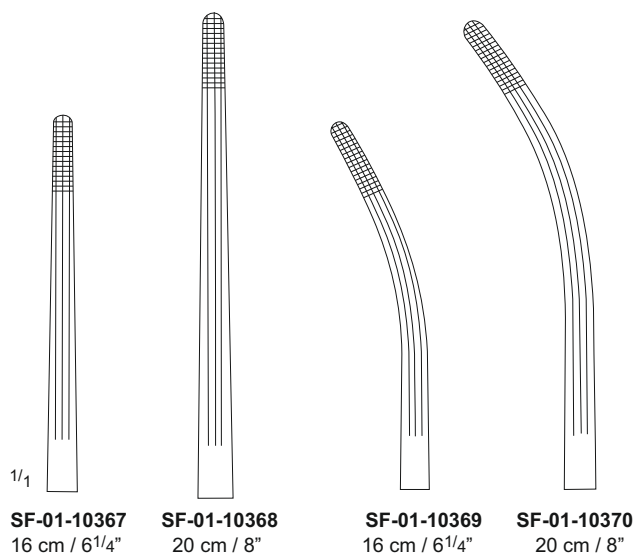

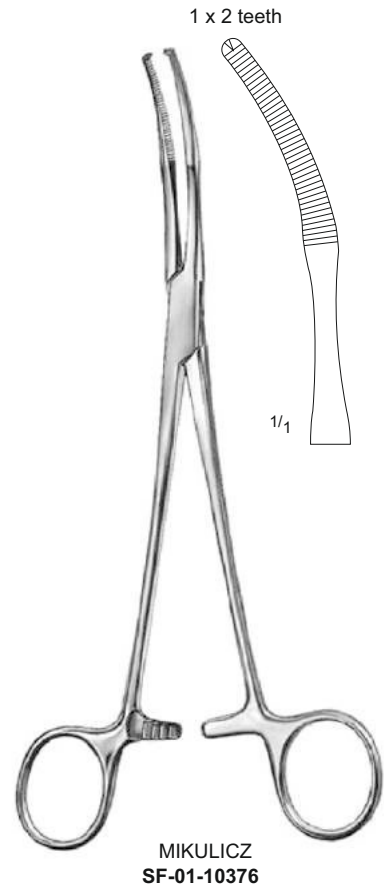
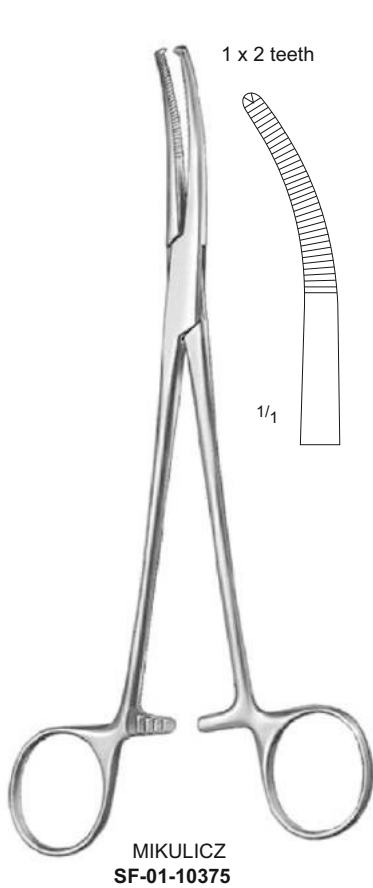
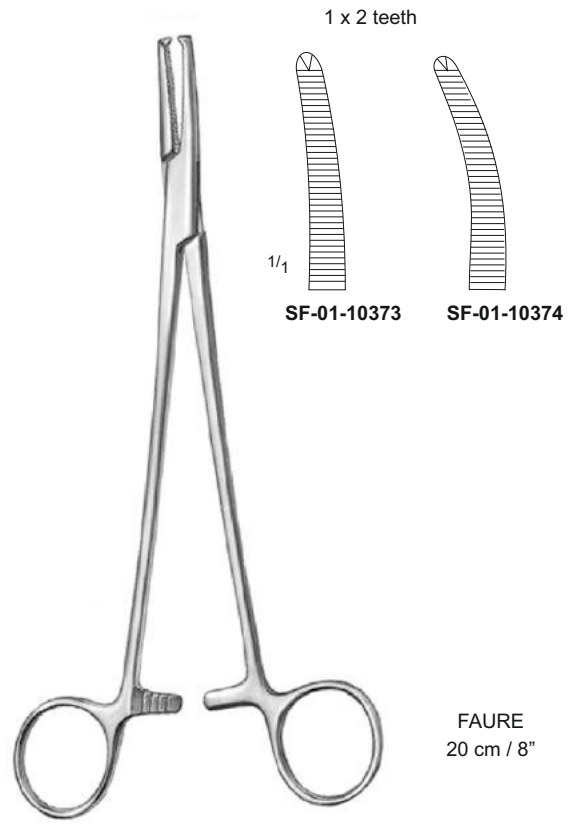
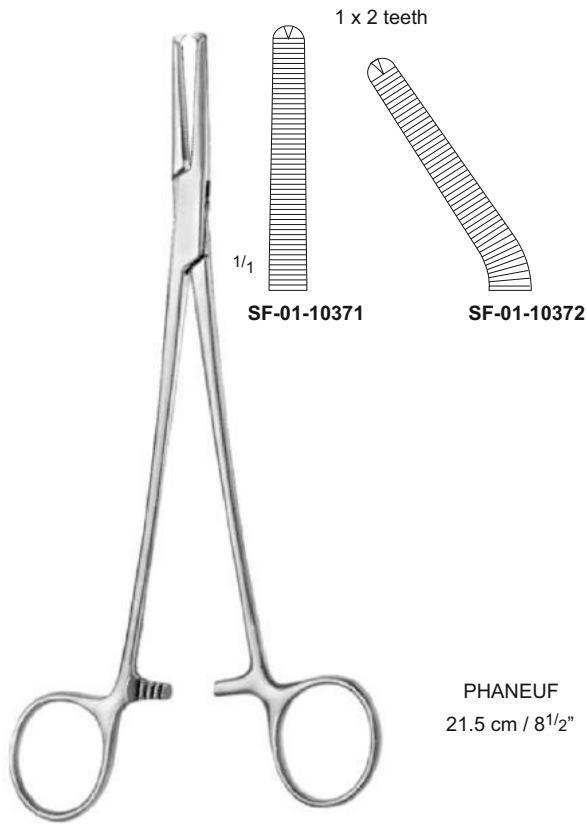

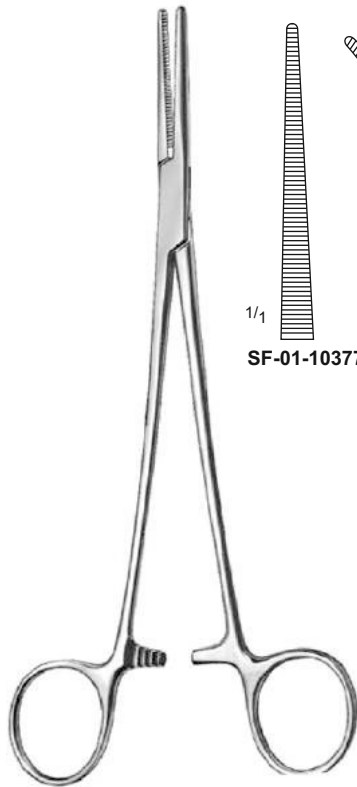

HEISS
20 cm / 8"

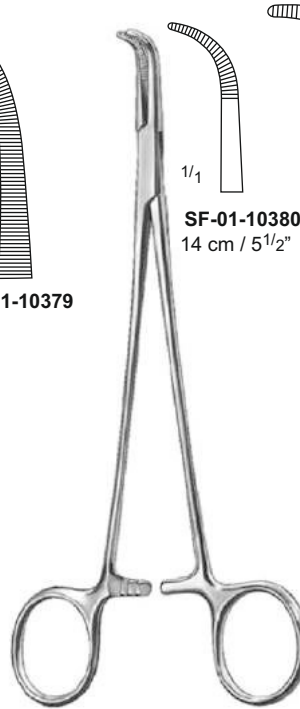
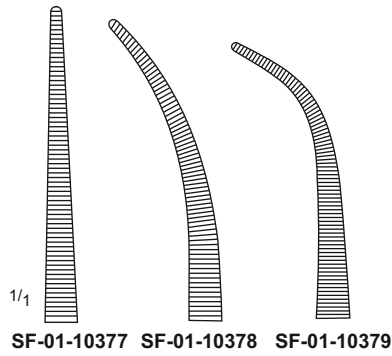

ADSON BABY

SF-01-10380 SF-01-10381
14 cm / 5 1/2" 19 cm / 7 1/2"



MIXTER BABY
SF-01-10382
19 cm / 7 1/2"

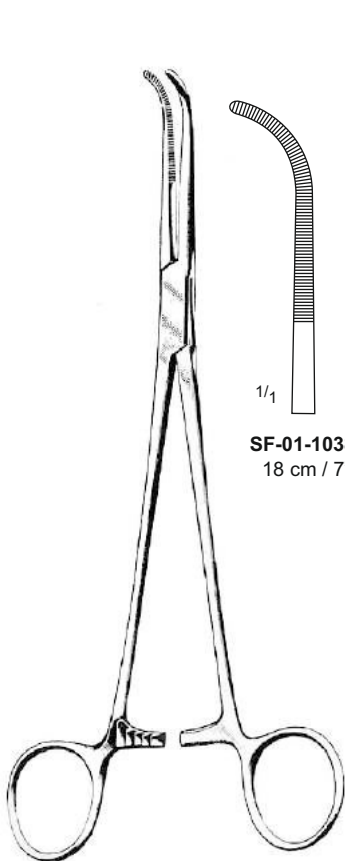

MIXTER

SF-01-10383 SF-01-10384
18 cm / 7" 23 cm / 9"

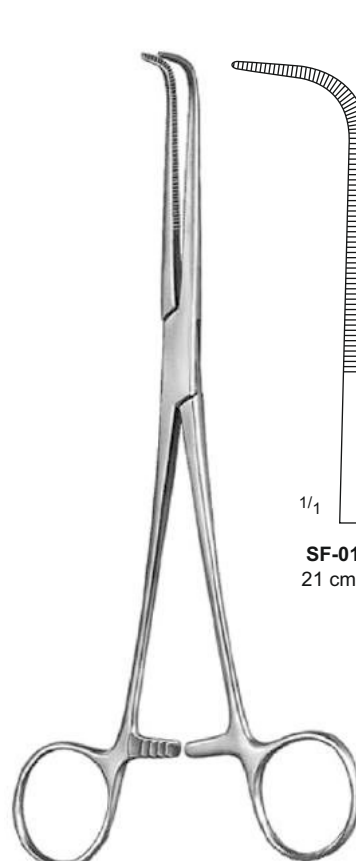

WICKSTROM

SF-01-10385 SF-01-10386
21 cm / 8 1/4" 24 cm / 9 1/2"

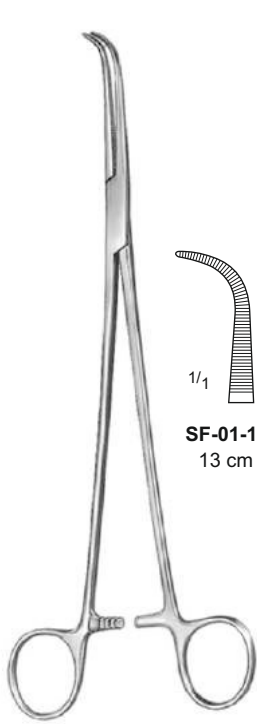

GEMINI

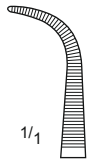

SF-01-10387
13 cm / 5"

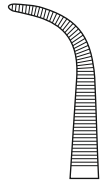

SF-01-10388
14 cm / 5 1/2"

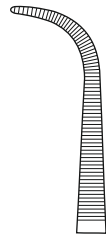

SF-01-10389
18 cm / 7"

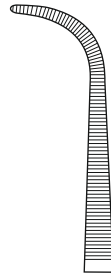

SF-01-10390
20 cm / 8"



SF-01-10391
23 cm / 9"



SF-01-10392
25 cm / 10"

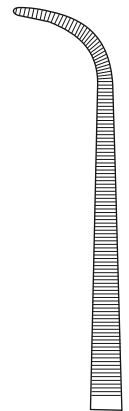

SF-01-10393
28 cm / 11"

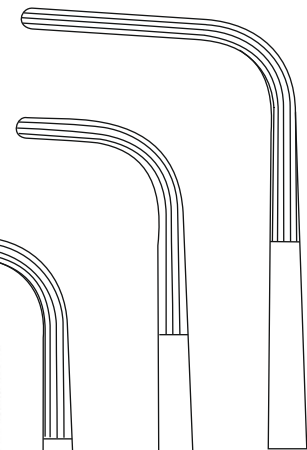

SF-01-10399
27 cm / 10 3/4"



SF-01-10393

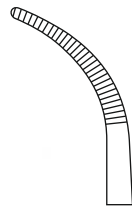

SF-01-10394



SCHNIDT
19 cm / 7 1/2"

1/1

Tonsil Seizing
Forceps

1/2

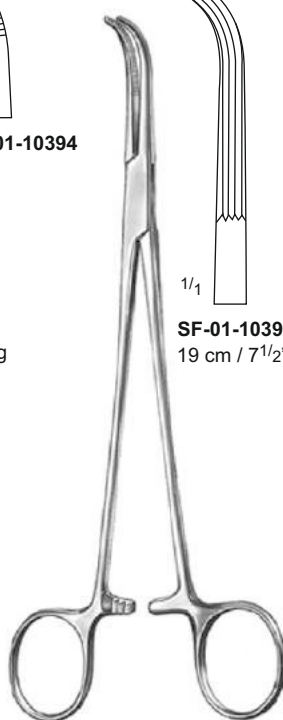

LAHEY

1/1

SF-01-10395 SF-01-10396
19 cm / 7 1/2" 23 cm / 9"

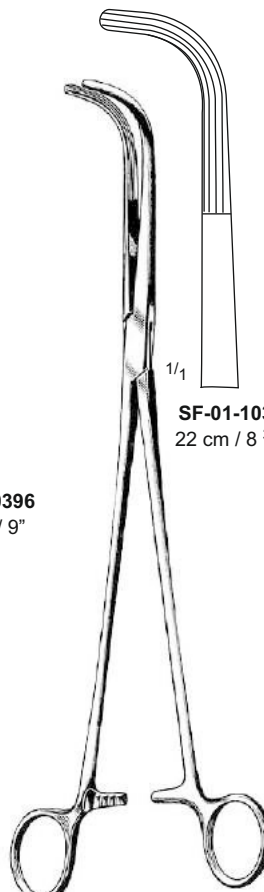

MIXTER

1/1

SF-01-10397
22 cm / 8 3/4"

SF-01-10398
25 cm / 10"

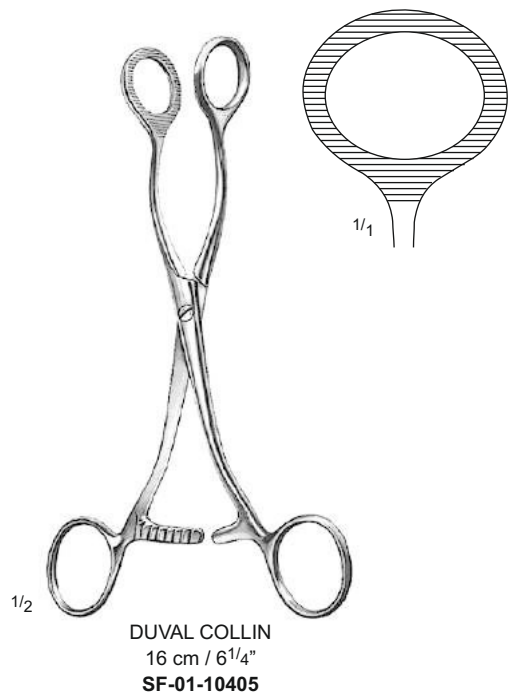
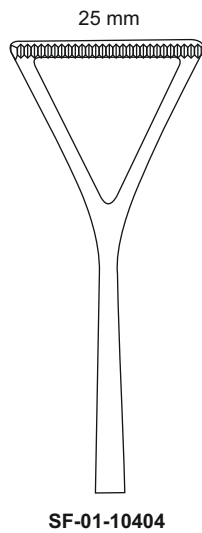
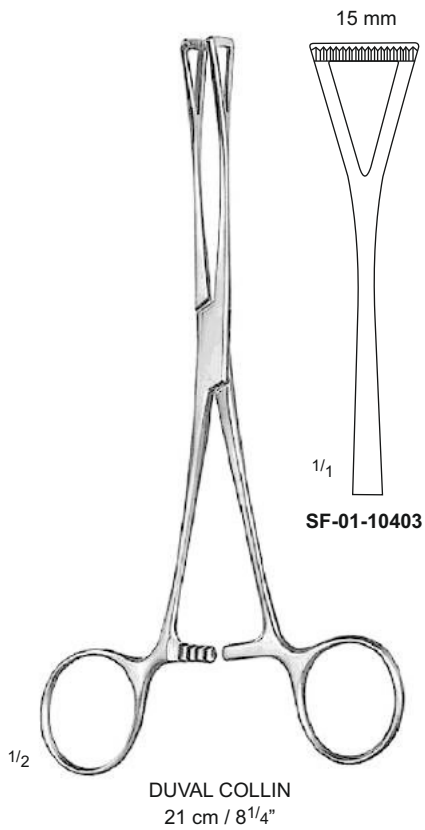
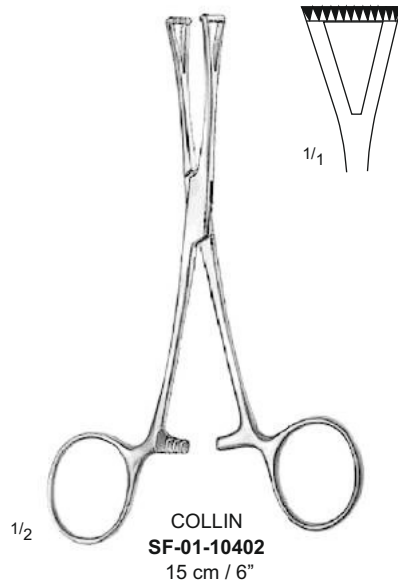
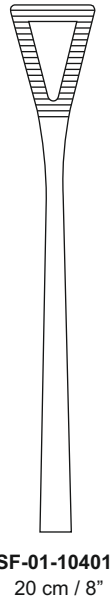
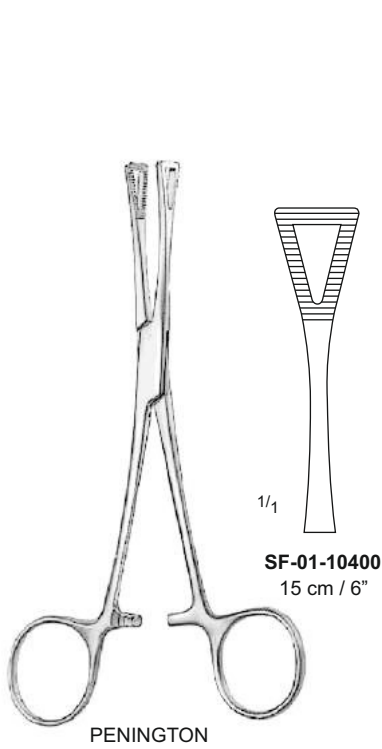



JONES
SF-01-10406
9 cm / 3 1/2"



SCHAEDEL
SF-01-10407
9 cm / 3 1/2"



BACKHAUS
SF-01-10408 – 8.5 cm / 3 1/4"
SF-01-10409 – 10.5 cm / 4 1/4"
SF-01-10410 – 13 cm / 5"
SF-01-10411 – 15 cm / 6"



BACKHAUS-ROEDER
SF-01-10412 – 13 cm / 5"
SF-01-10413 – 15 cm / 6"



BALL & SOCKET
SF-01-10414 – 13 cm / 5"
SF-01-10415 – 15 cm / 6"



LANE
SF-01-10416 – 15 cm / 6"
SF-01-10417 – 18 cm / 7"
SF-01-10418 – 20 cm / 8"

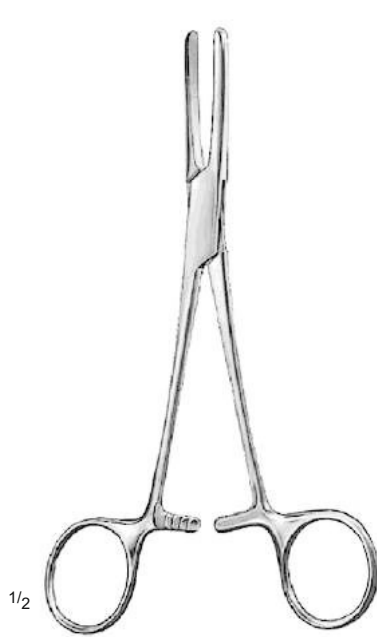

PRESBYTARIAN HOSPITAL

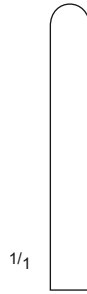

SF-01-10419
16 cm/ 6 1/4"



SF-01-10420
18 cm/ 7"



SF-01-10421
20 cm/ 8"



SCHOENBERG

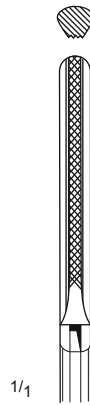

SF-01-10422
16 cm/ 6 1/4"

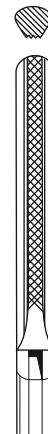

SF-01-10423
18 cm/ 7"

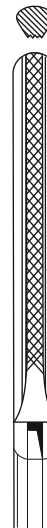

SF-01-10424
20 cm/ 8"

Needle Holder & Sutures



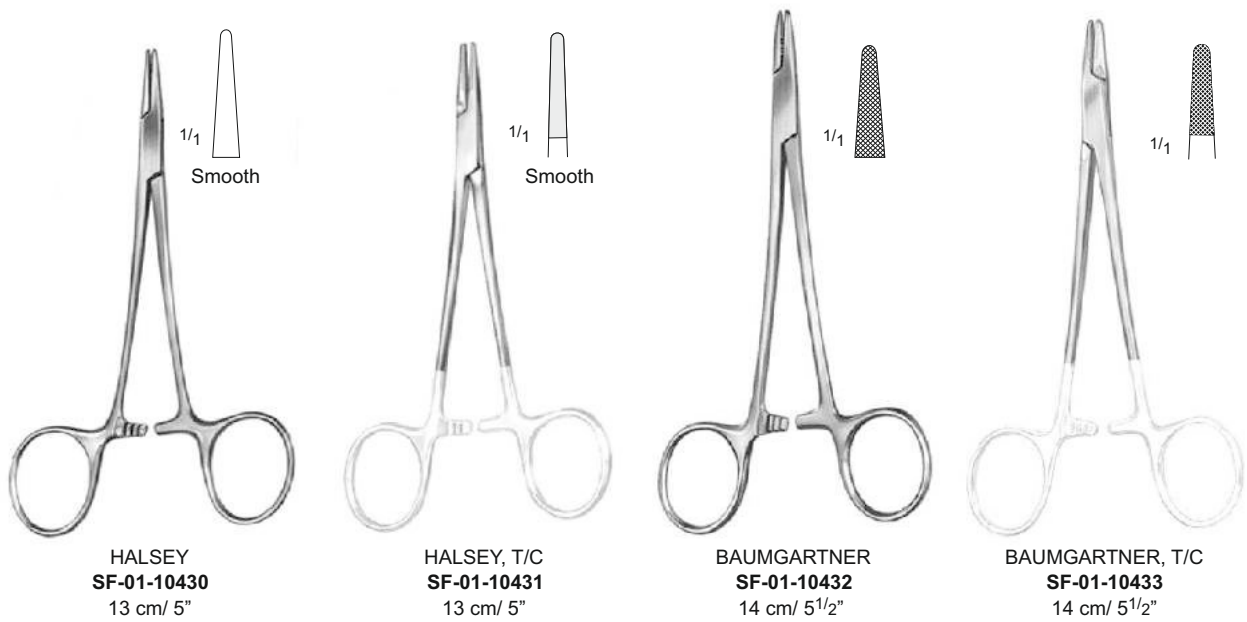
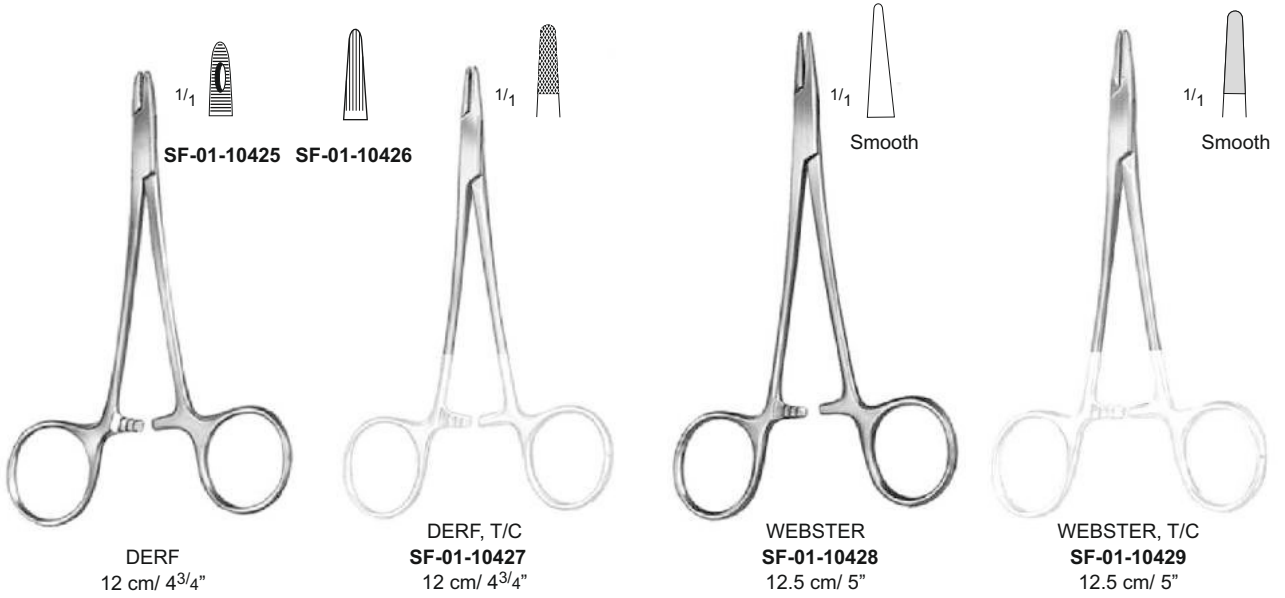

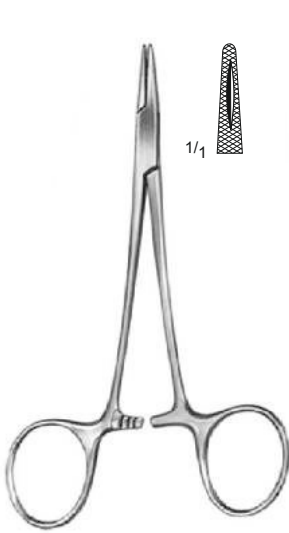

WRIGHT (DERF)
SF-01-10434
12.5 cm / 5"

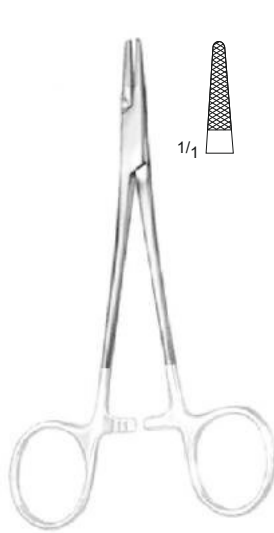

WRIGHT (DERF), T/C
SF-01-10435
12.5 cm / 5"

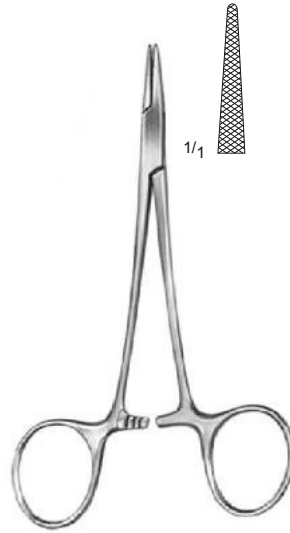

HALSEY
SF-01-10436
13.5 cm / 5 1/4"

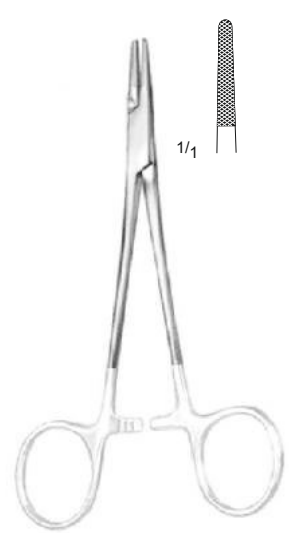

HALSEY, T/C
SF-01-10437
13.5 cm / 5 1/4"



CRILE WOOD

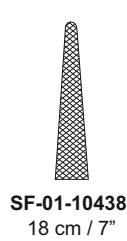

SF-01-10438
18 cm / 7"

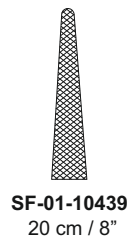

SF-01-10439
20 cm / 8"

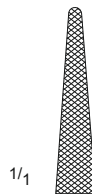

SF-01-10440
23 cm / 9"



CRILE WOOD, T/C
(DEBAKEY)

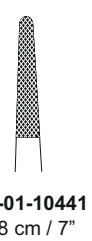

SF-01-10441
18 cm / 7"

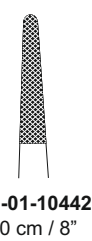

SF-01-10442
20 cm / 8"

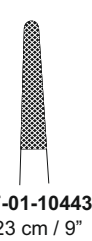

SF-01-10443
23 cm / 9"

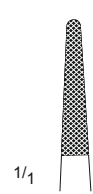

SF-01-10444
25 cm / 10"



SF-01-10445
30 cm / 12"



MAYO HEGAR

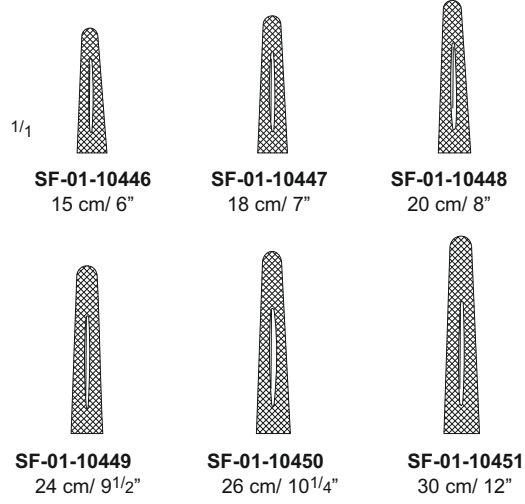

MAYO HEGAR, T/C

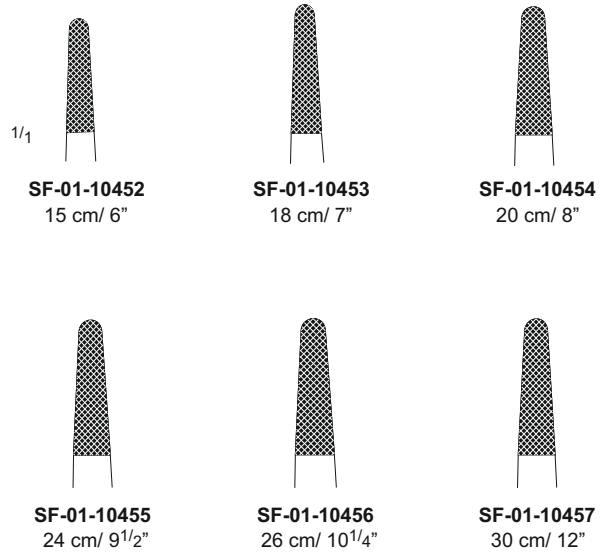



CRILE MURRAY
SF-01-10458
15 cm / 6"



Grooved Jaws

CRILE WOOD
SF-01-10459
15 cm / 6"



CRILE WOOD, T/C
SF-01-10460
15 cm / 6"

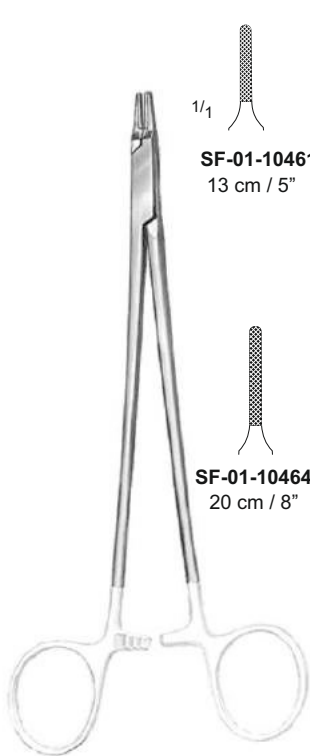

RYDER (FRENCH EYE), T/C

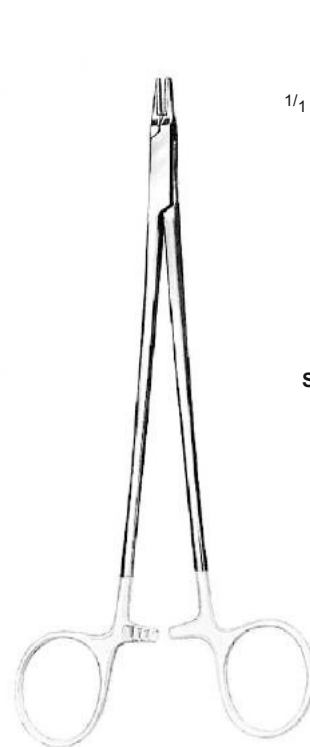
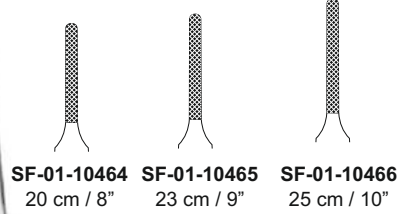
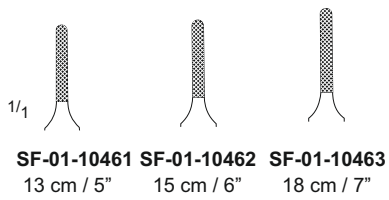

RYDER (VASCULAR), T/C

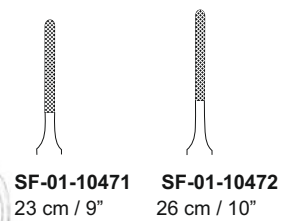
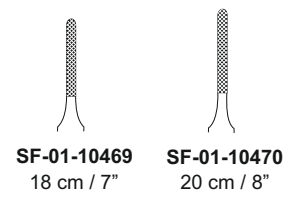
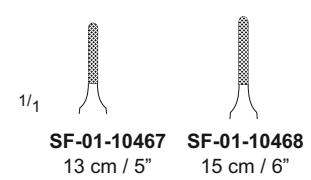

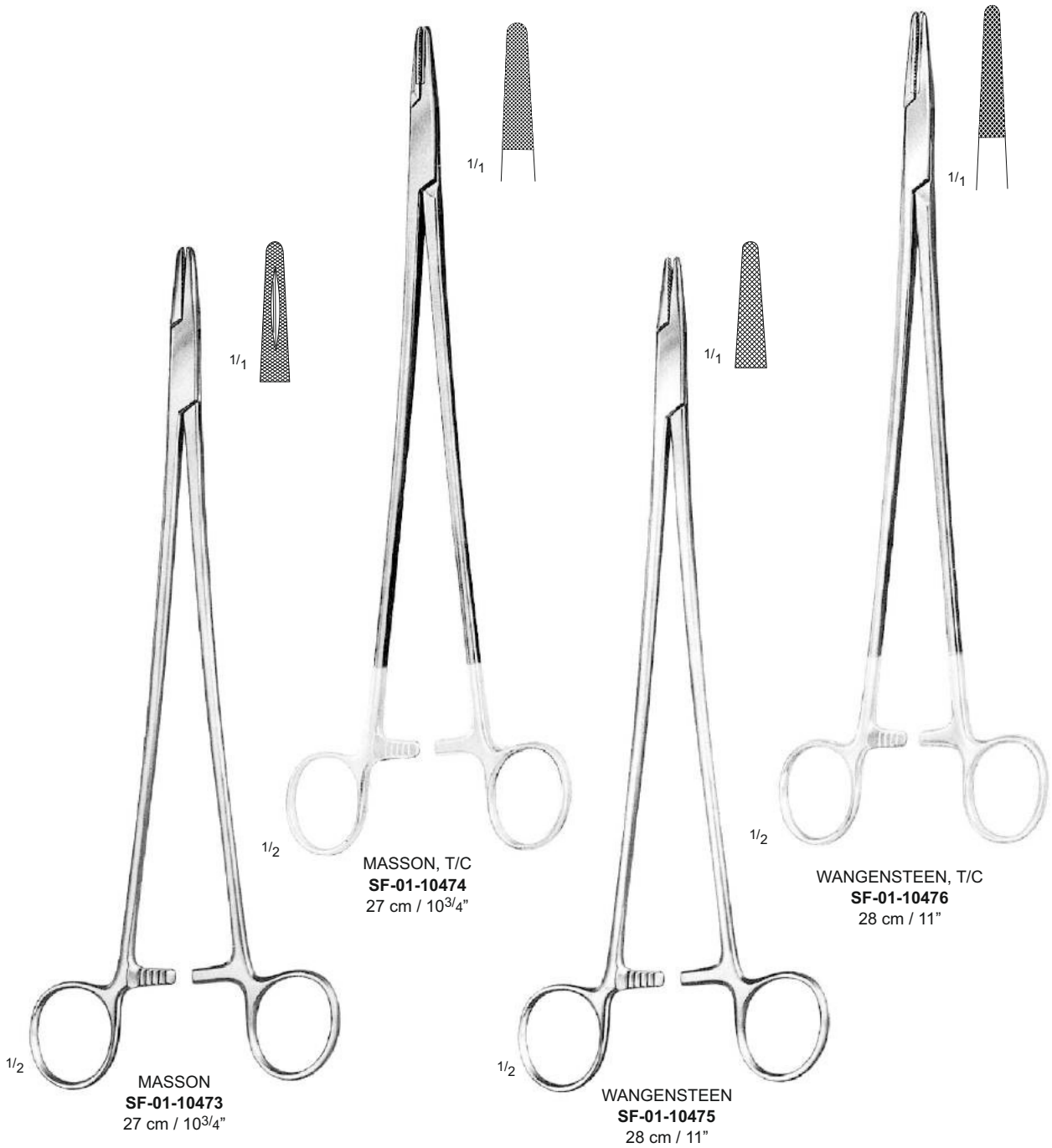

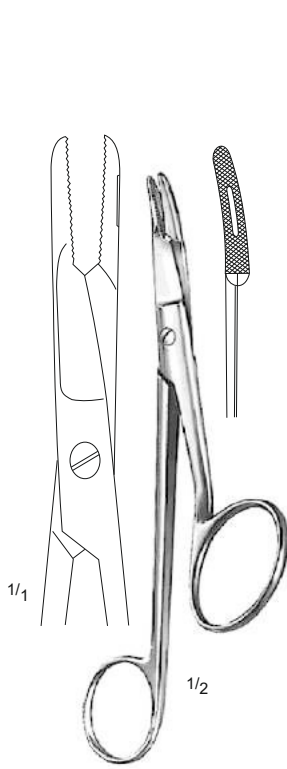

GILLIES
SF-01-10477
15 cm / 6"

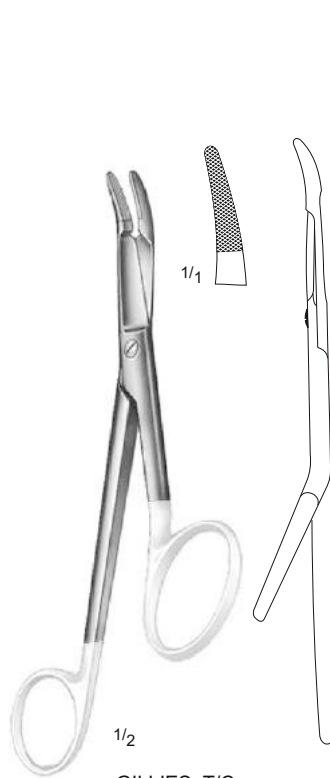

GILLIES, T/C
SF-01-10478
15 cm / 6"

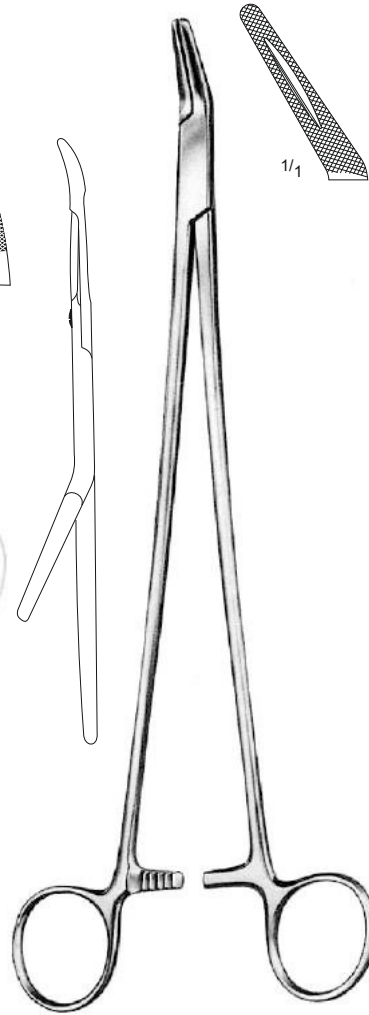

FINOCHIETTO
SF-01-10479
27 cm / 10³/₄"

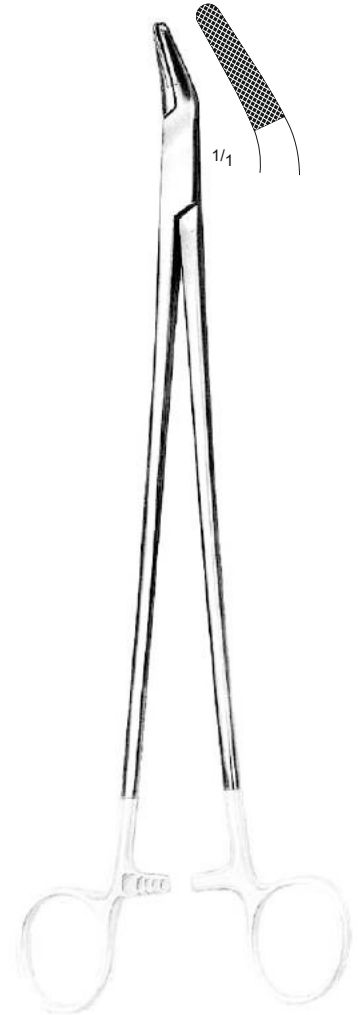

FINOCHIETTO, T/C
SF-01-10480
27 cm / 10³/₄"

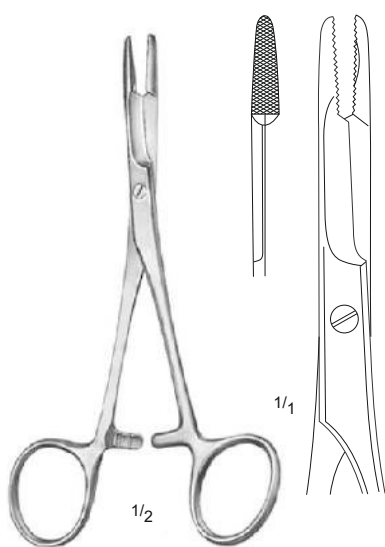

OLSEN HEGAR
SF-01-10481
14 cm / 5¹/₂"



OLSEN HEGAR, T/C

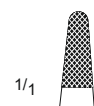

SF-01-10482
14 cm / 5¹/₂"



SF-01-10483
17 cm / 6³/₄"



MATHIEU KOCHER
09. 65.14 – 09. 65.17

SF-01-10484 SF-01-10485
14 cm / 5½" 17 cm / 6¾"



MATHIEU KOCHER, T/C
09. 66.14 – 09. 66.20

SF-01-10486 SF-01-10487 SF-01-10488
14 cm / 5½" 17 cm / 6¾" 20 cm / 8"



MATHIEU
09. 67.14 – 09. 67.20

SF-01-10489 SF-01-10490 SF-01-10491
14 cm / 5½" 17 cm / 6¾" 20 cm / 8"



MATHIEU

SF-01-10492 SF-01-10493 SF-01-10494
14 cm / 5 1/2" 17 cm / 6 3/4" 20 cm / 8"



MATHIEU, T/C

SF-01-10495 SF-01-10496 SF-01-10497
14 cm / 5½" 17 cm / 6¾" 20 cm / 8"



MATHIEU T/C

SF-01-10498 SF-01-10499
17 cm / 6¾" 20 cm / 8"



SF-01-10500

SF-01-10501

CASTROVIEJO - STANDARD
14 cm / 5 1/2"

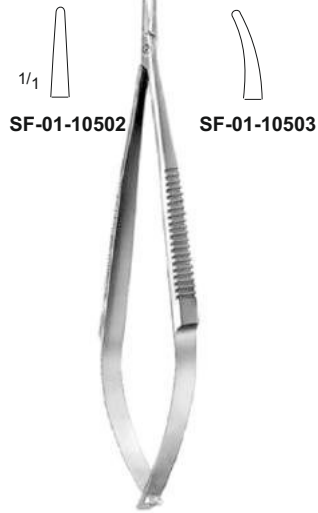

SF-01-10502

SF-01-10503

CASTROVIEJO - STANDARD
14 cm / 5 1/2"

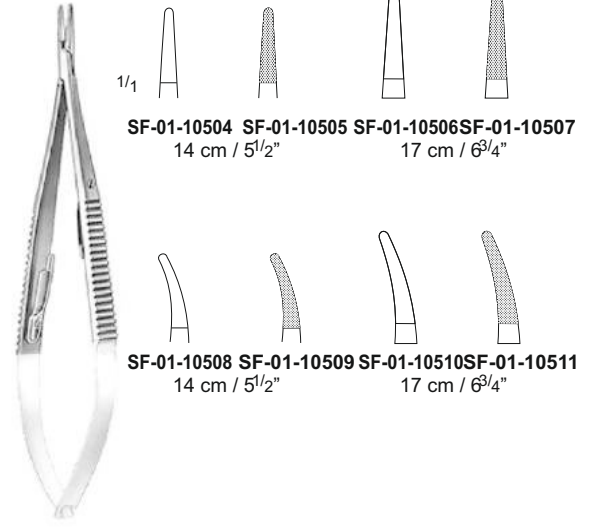

SF-01-10504
14 cm / 5 1/2"

SF-01-10505

SF-01-10506
17 cm / 6 3/4"

SF-01-10507

SF-01-10508
14 cm / 5 1/2"

SF-01-10509

SF-01-10510
17 cm / 6 3/4"

SF-01-10511

CASTROVIEJO
(JACOBSON) T/C

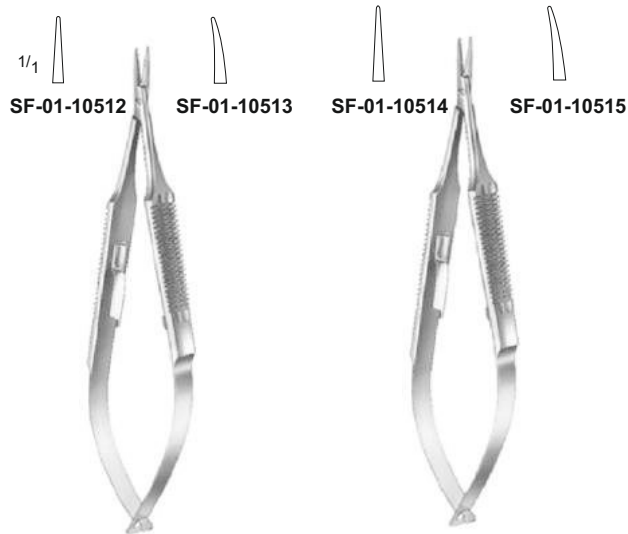

SF-01-10512

SF-01-10513

SF-01-10514

SF-01-10515

CASTROVIEJO - MICRO
14 cm / 5 1/2"

CASTROVIEJO - MICRO
14 cm / 5 1/2"

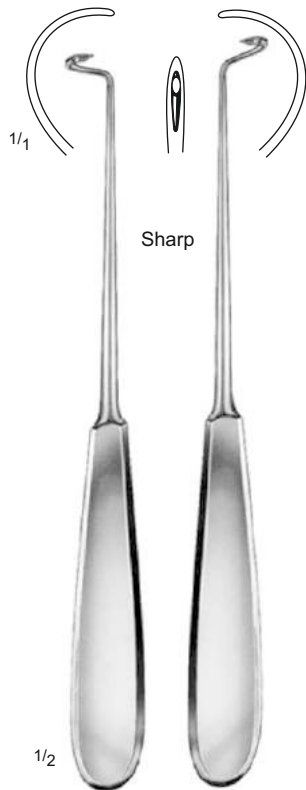

DESCHAMPS - BABY
SF-01-10516 SF-01-10517
20 cm / 8"

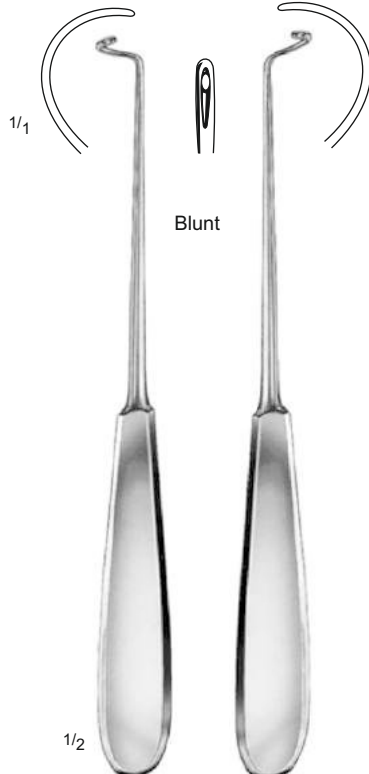

DESCHAMPS - BABY
SF-01-10518 SF-01-10519
20 cm / 8"

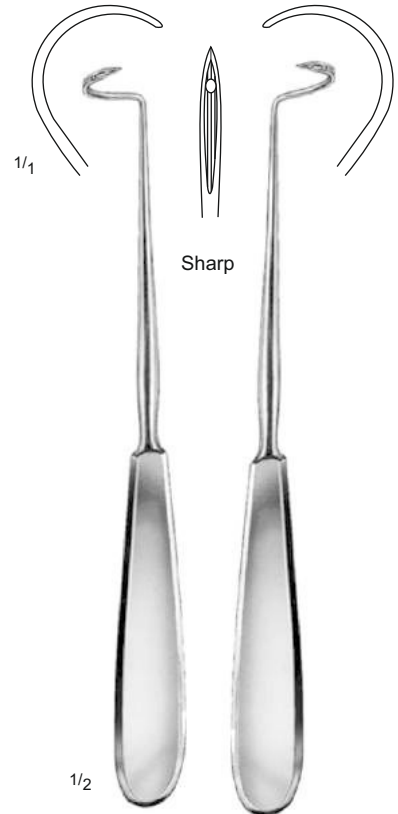

DESCHAMPS - BABY
SF-01-10520 SF-01-10521
20 cm / 8"

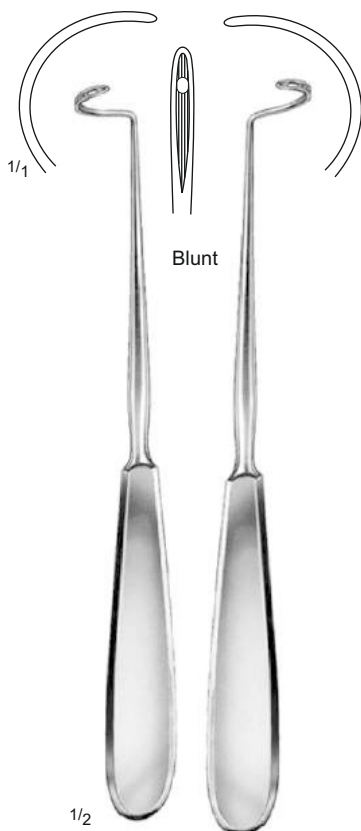

DESCHAMPS
SF-01-10522 SF-01-10523
20 cm / 8"

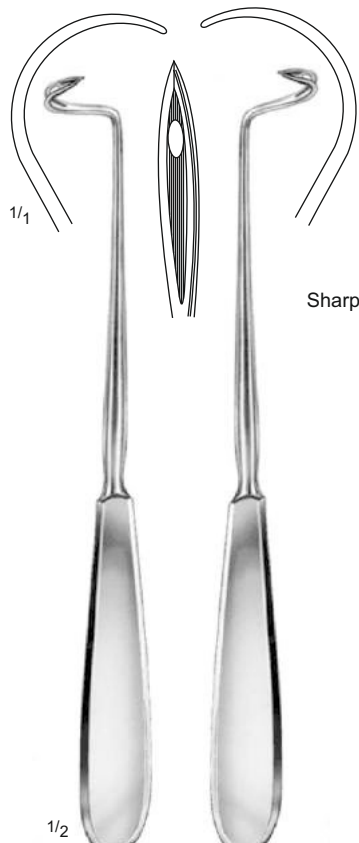

DESCHAMPS
SF-01-10524 SF-01-10525
20 cm / 8"

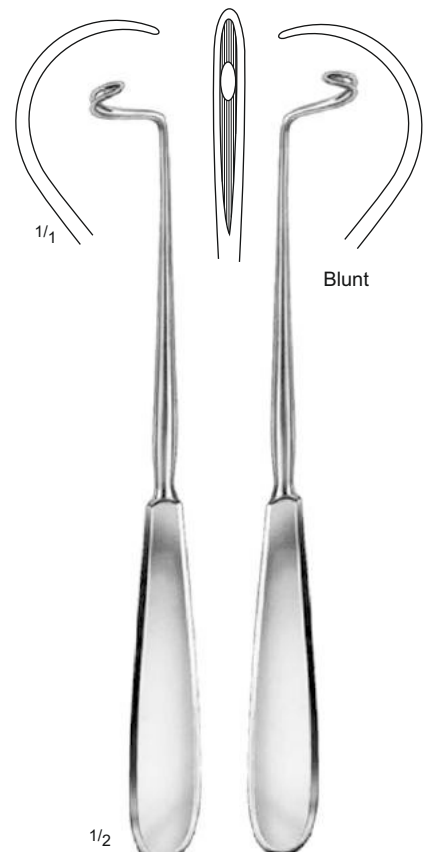

DESCHAMPS
SF-01-10526 SF-01-10527
20 cm / 8"

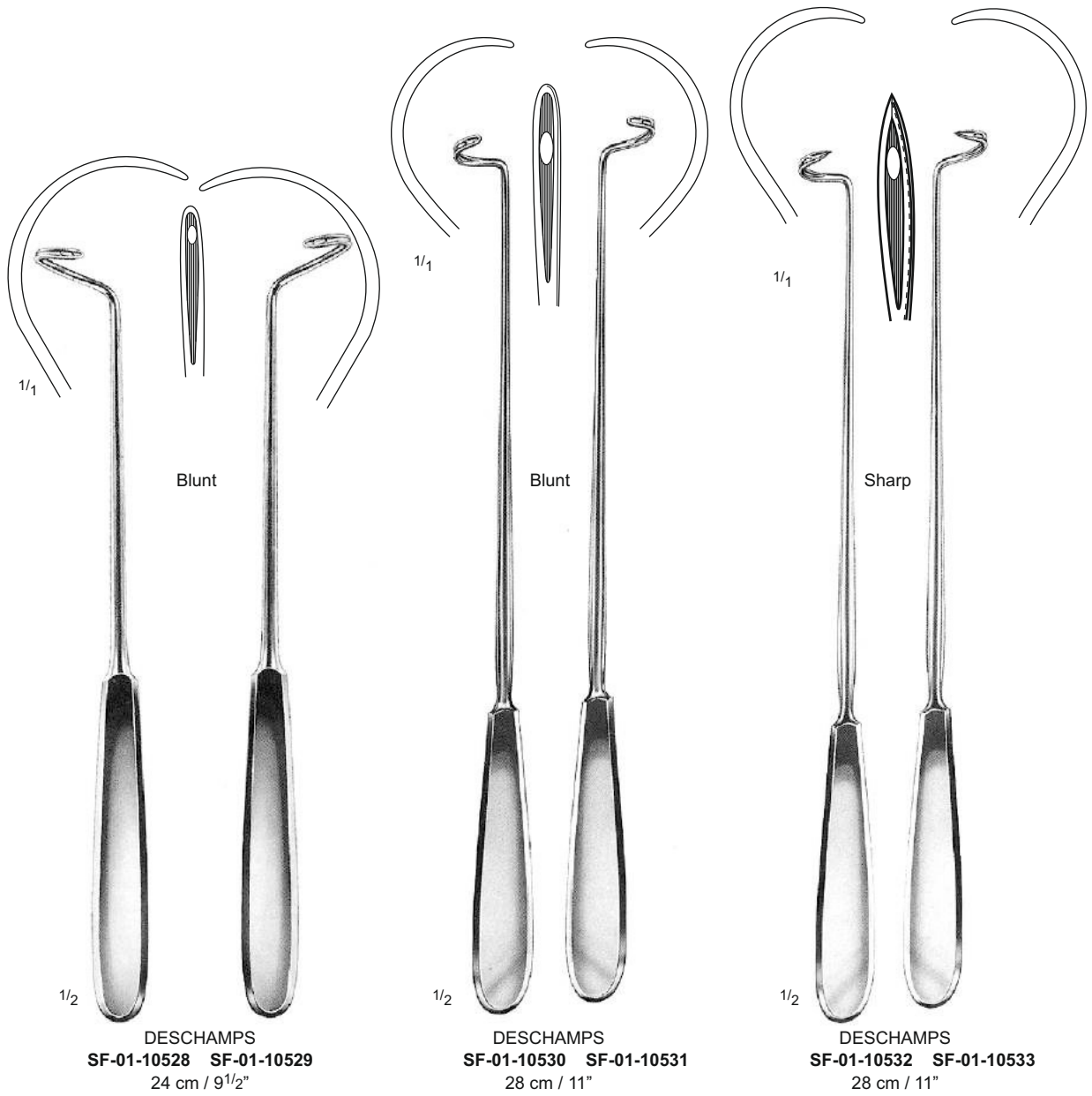

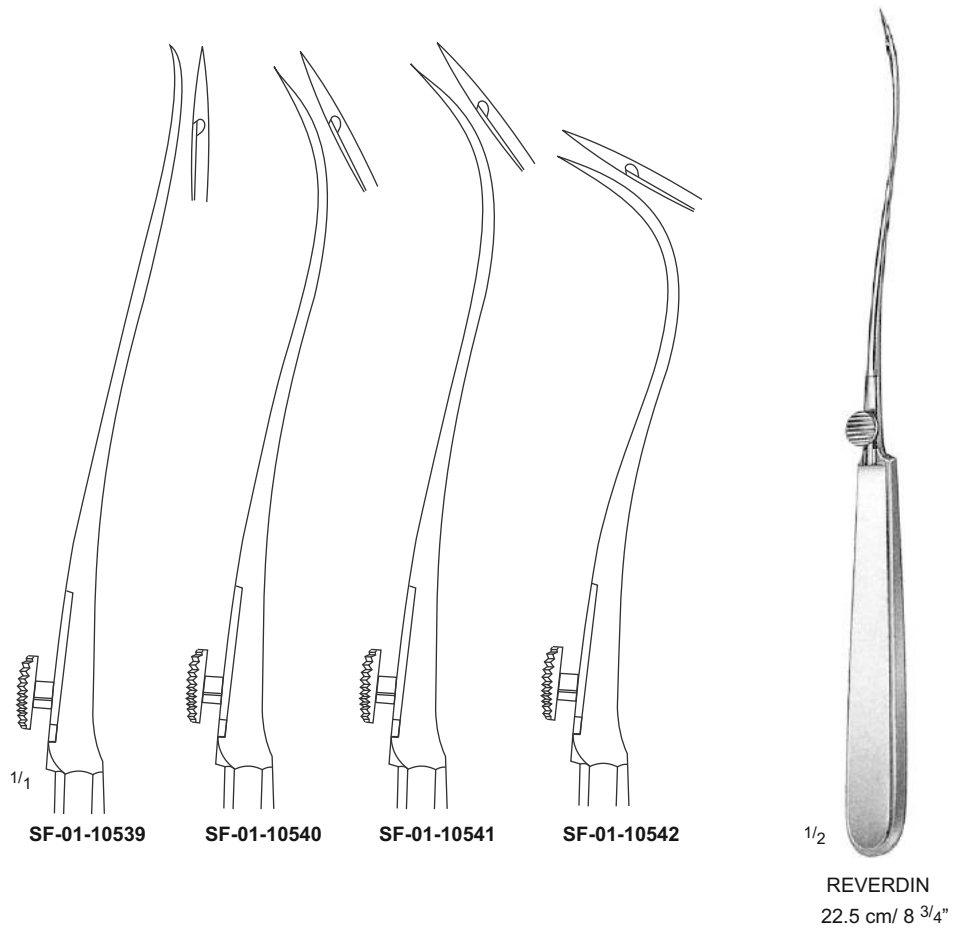
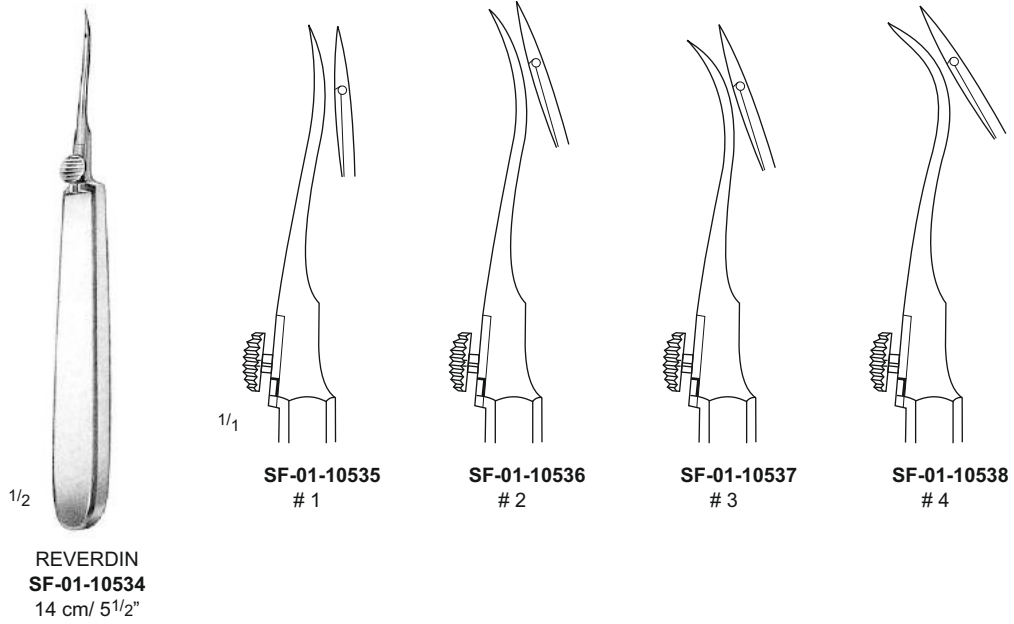



1/2

MICHEL
SF-01-10543
12.5 cm / 5"



1/2

HEGENBARTH
SF-01-10544
12 cm / 4³/₄"



1/2

MICHEL
SF-01-10545
12 cm / 4³/₄"



1/2

COLLIN
SF-01-10546
13 cm / 5"

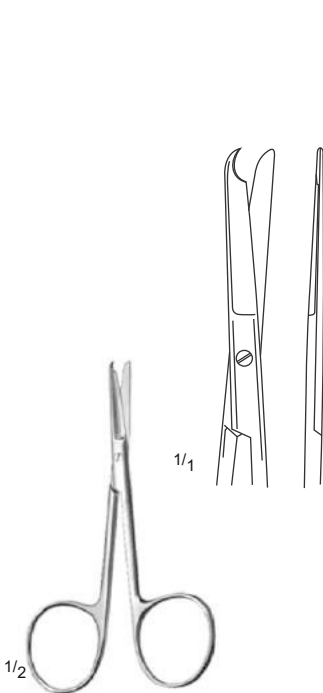

1/2

SPENCER
SF-01-10547
9 cm / 3¹/₂"

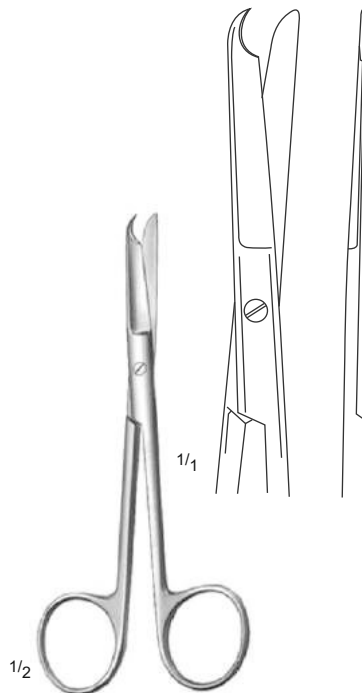

1/2

SPENCER
SF-01-10548 – 10.5 cm / 4"
SF-01-10549 – 12 cm / 4³/₄"
SF-01-10550 – 14 cm / 5³/₄"

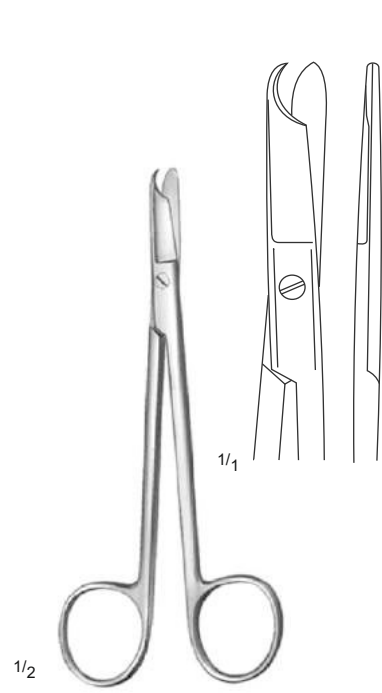

1/2

LITTAUER
SF-01-10551
13 cm / 5"

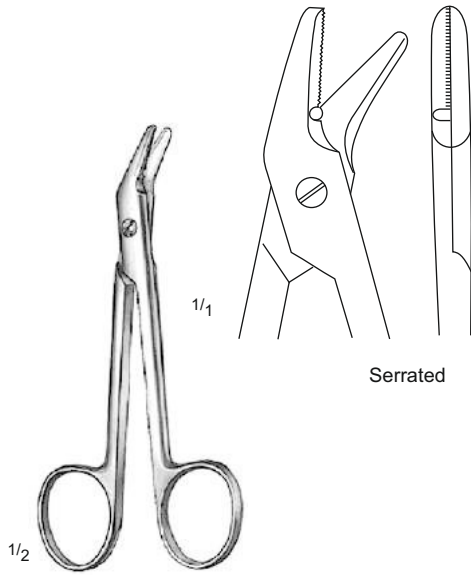

Serrated

UNIVERSAL
SF-01-10552
12 cm / 4³/₄"

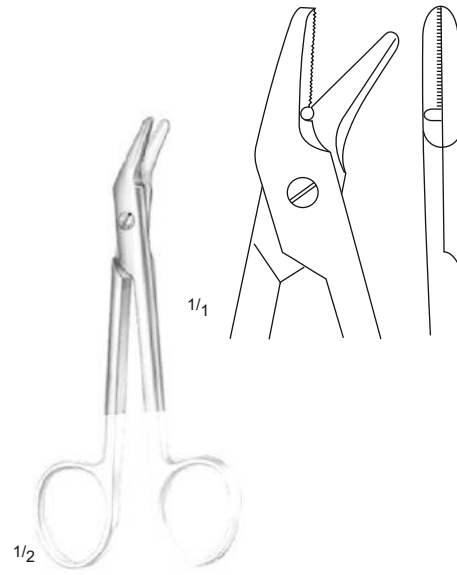

UNIVERSAL, T/C
SF-01-10553
12 cm / 4³/₄"

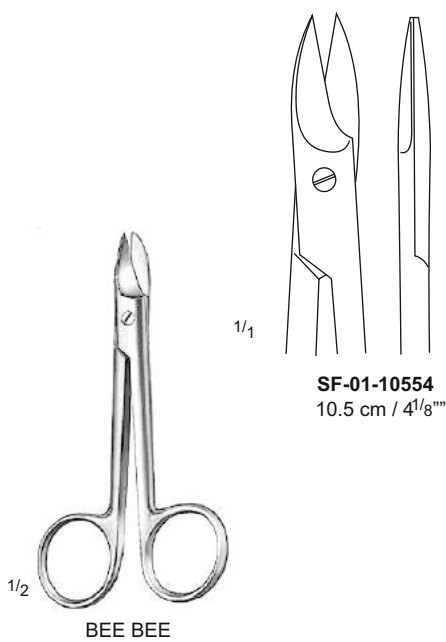

BEE BEE

SF-01-10554
10.5 cm / 4¹/₈"

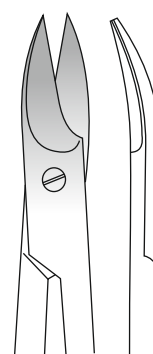

SF-01-10555
10.5 cm / 4¹/₈"

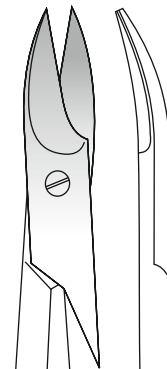

SF-01-10556
10.5 cm / 4¹/₈"
one blade serrated

Bandage & Plaster



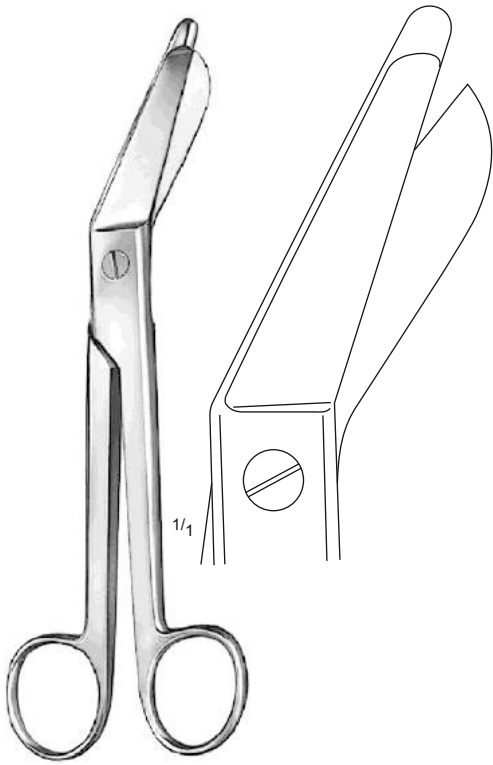

ESMARCH
SF-01-10557 - 20 cm / 8"
SF-01-10558 - 22 cm / 8³/₄"



ESMARCH
SF-01-10559
23 cm / 4"

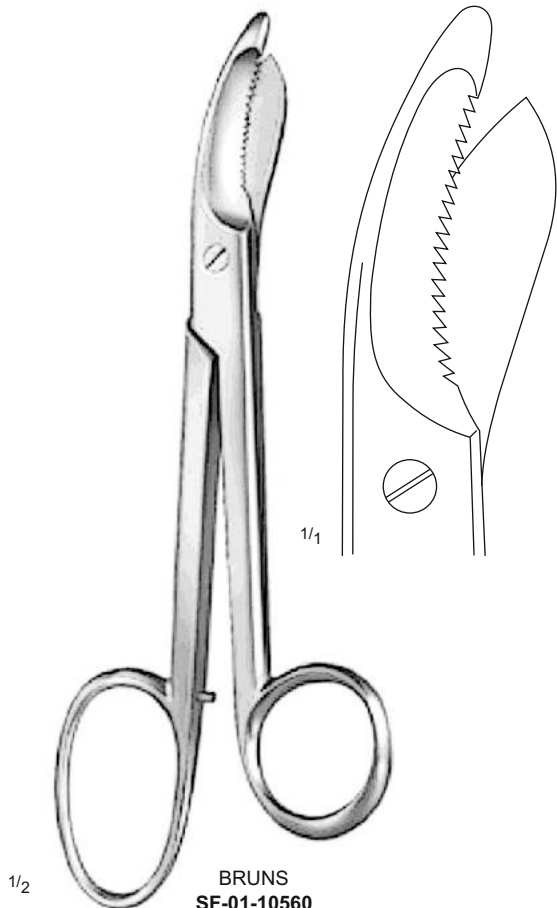

BRUNS
SF-01-10560
23.5 cm / 9¹/₄"



UNIVERSAL
SF-01-10561 - 15 cm / 6"
SF-01-10562 - 18 cm / 7"
(Black Handle)
Other Colours Available

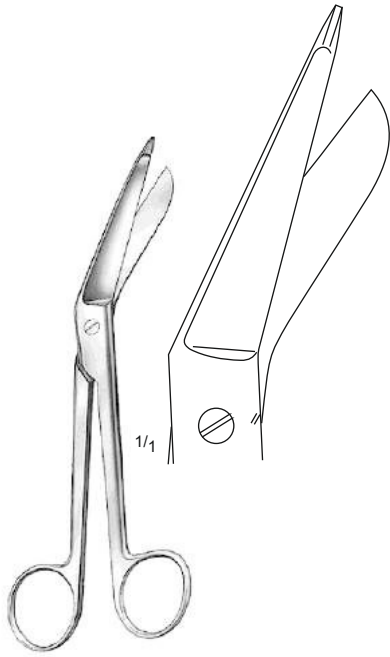

LISTER

- SF-01-10563 – 11.5 cm / 1/2"
- SF-01-10564 – 14 cm / 5 1/2"
- SF-01-10565 – 18 cm / 7"
- SF-01-10566 – 20 cm / 8"

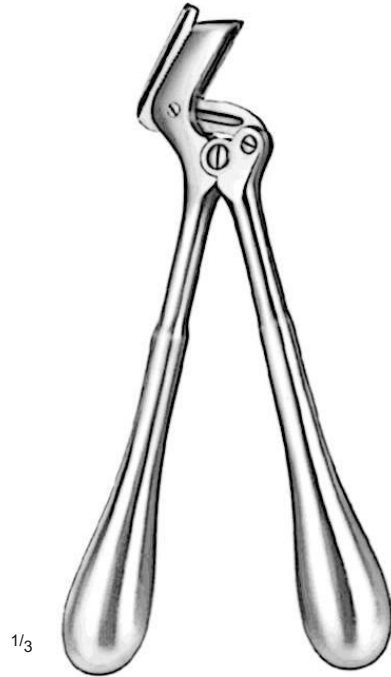

STILLE

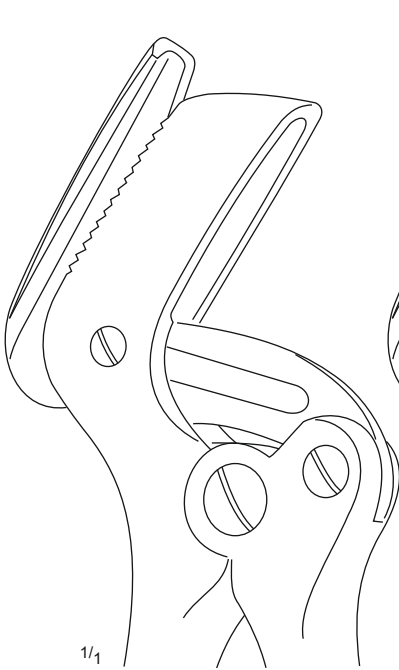

SF-01-10567
23 cm / 9"

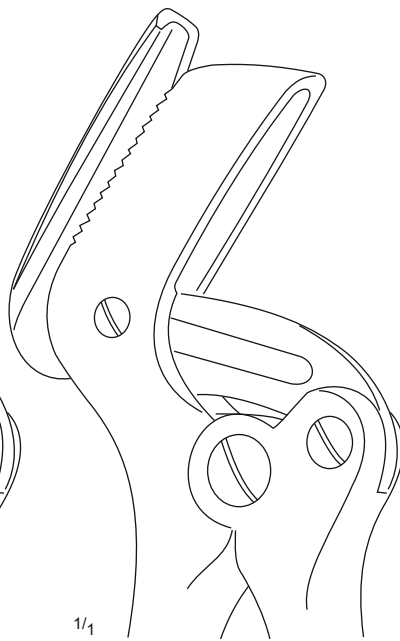

SF-01-10568
26 cm / 10 1/4"

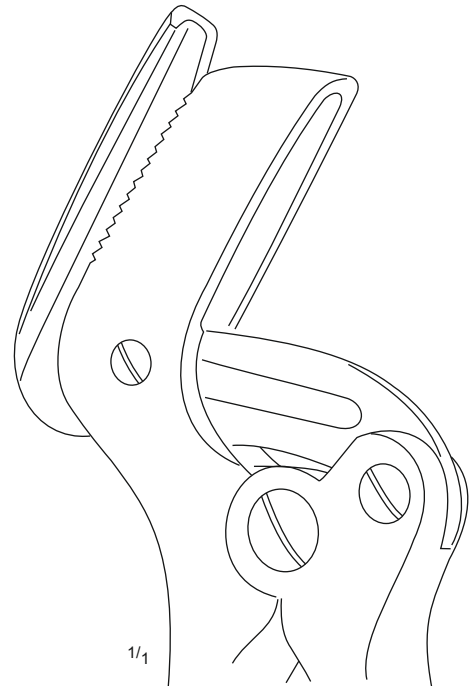

SF-01-10569
37 cm / 14 1/2"



BRUNS, T/C
SF-01-10570
23.5 cm / 9¹/₄"

LISTER, T/C
SF-01-10571 – 14 cm / 5¹/₂"
SF-01-10572 – 18 cm / 7"

SF-01-10573
21 cm / 8¹/₄"

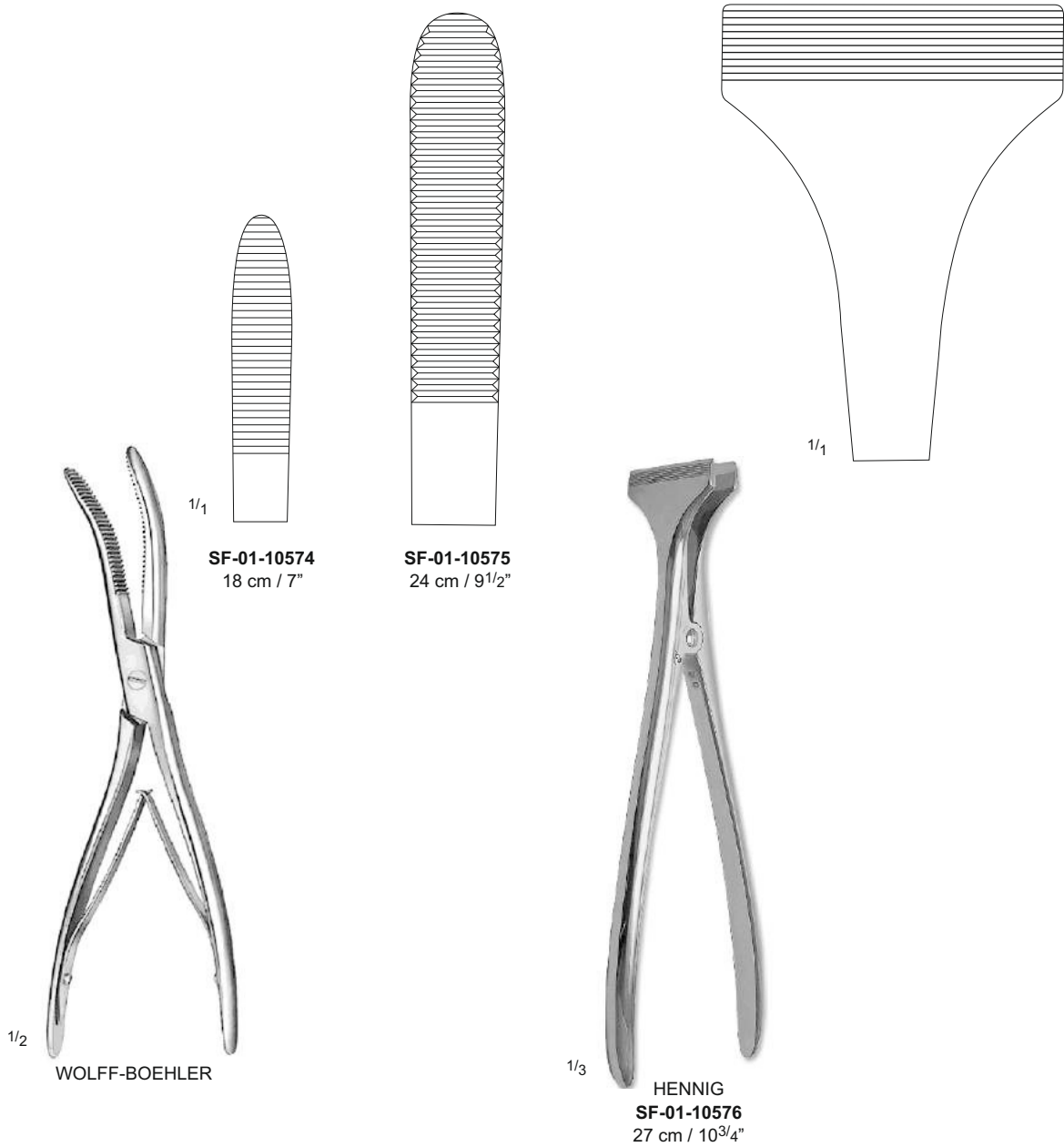

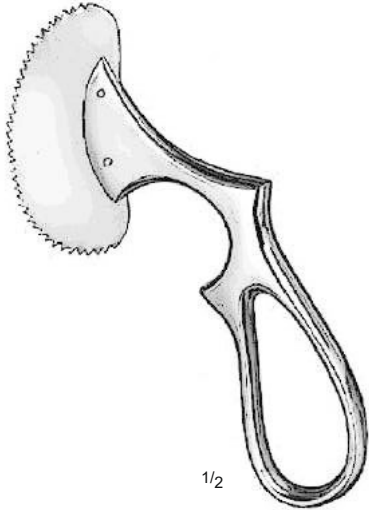

1/2

ENGEL
SF-01-10577
15 cm / 6"



1/2

ESMARCH
SF-01-10578
18 cm / 7"



1/2

HOPKINS
SF-01-10579
20 cm / 8"



1/2

REINER
SF-01-10580
19 cm / 7 1/2"

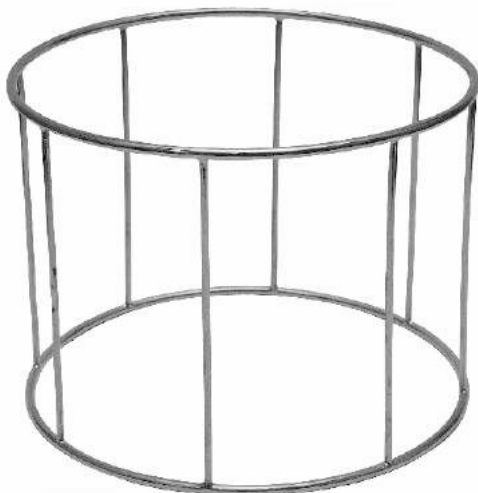

SIZE A
SF-01-10581

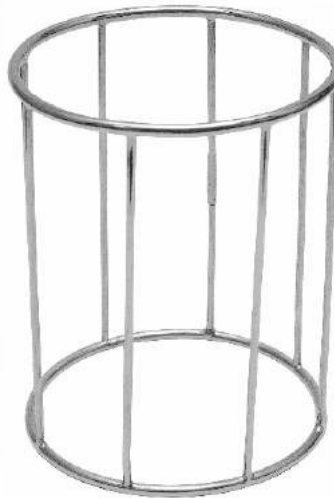

SIZE B
SF-01-10582



SIZE C
SF-01-10583



SIZE C
SF-01-10584

Intestinal Rectal



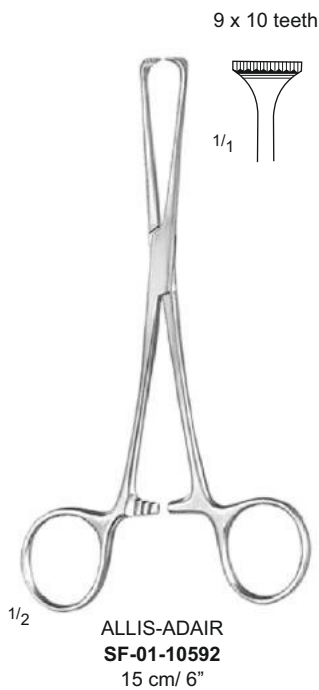
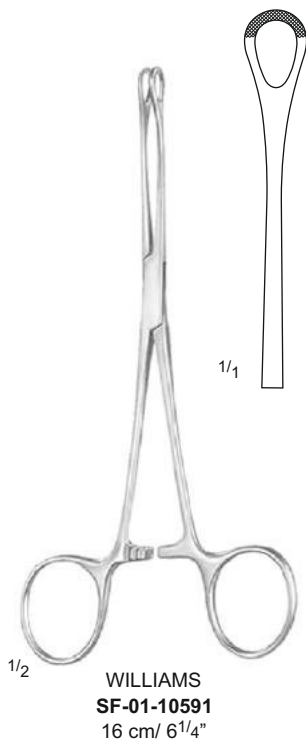
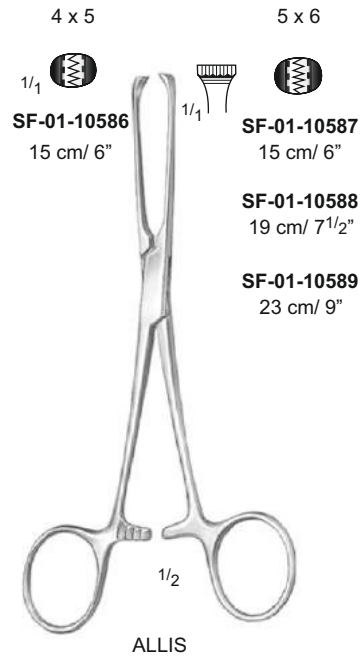

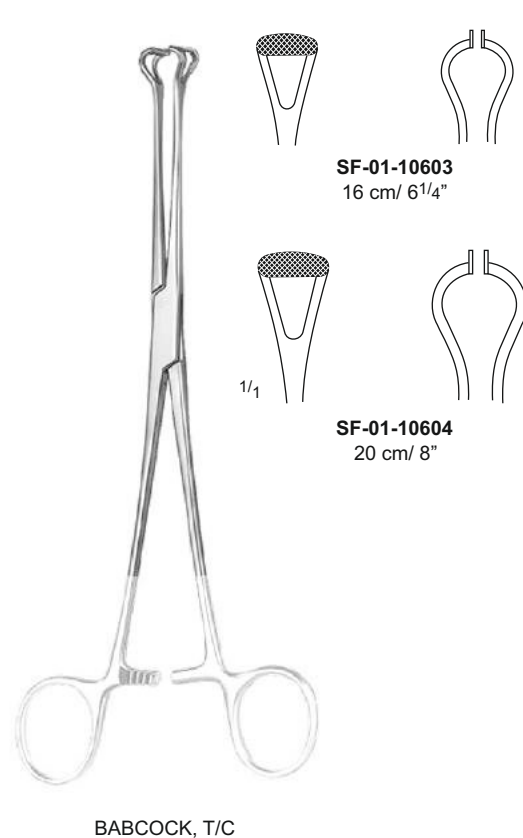
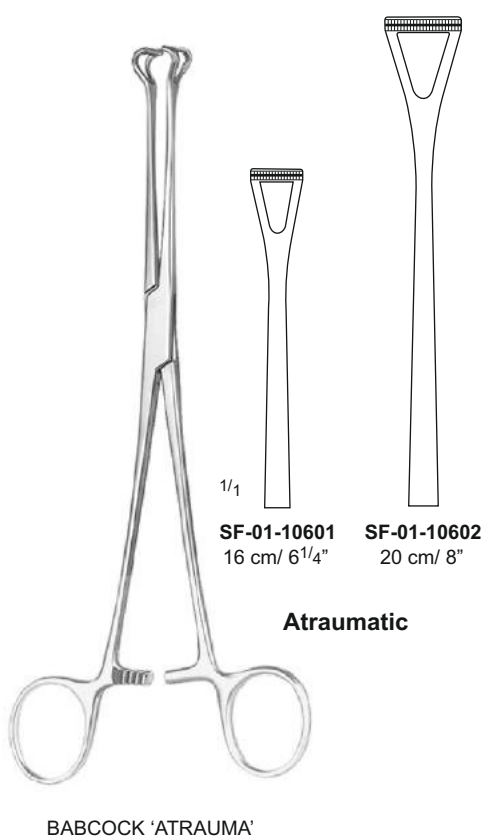
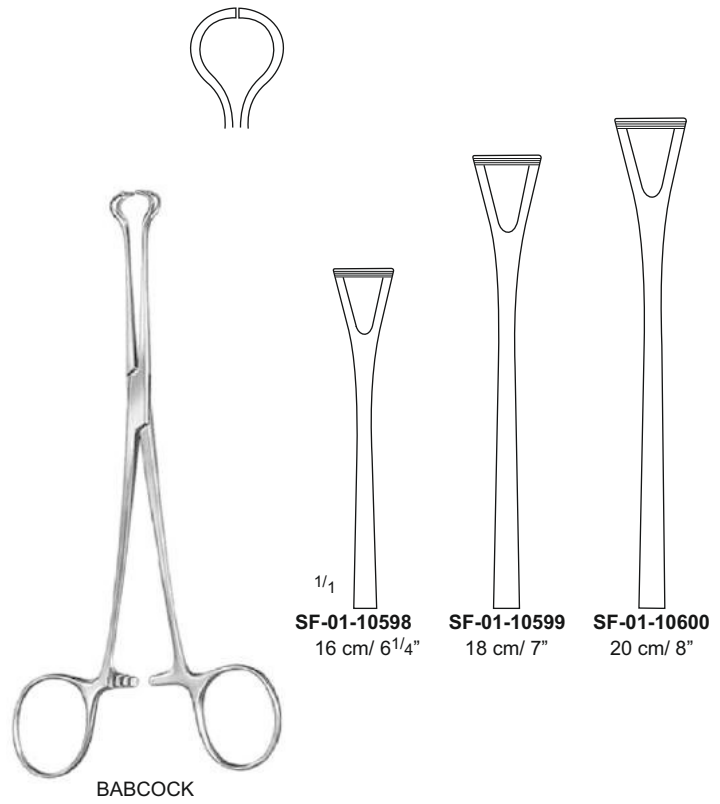
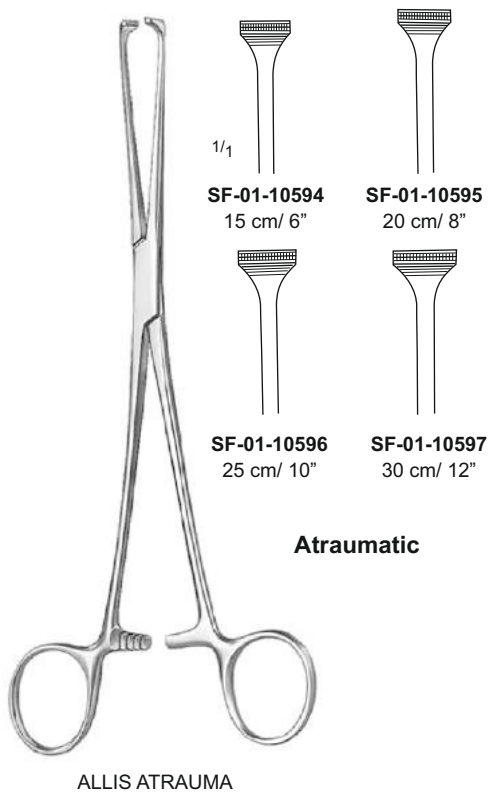

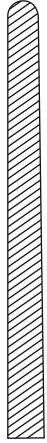

SF-01-10605

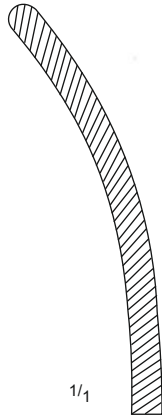

SF-01-10606

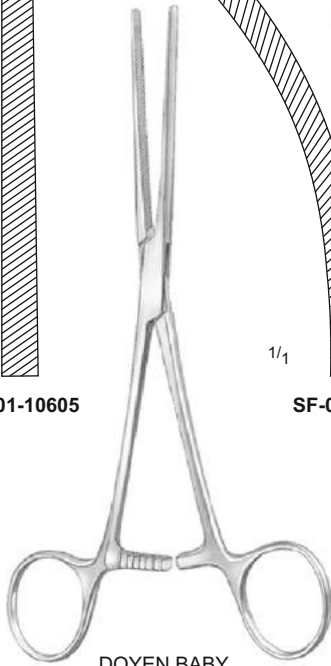

DOYEN BABY
17 cm / 6³/₄"



SF-01-10607
23 cm / 9"

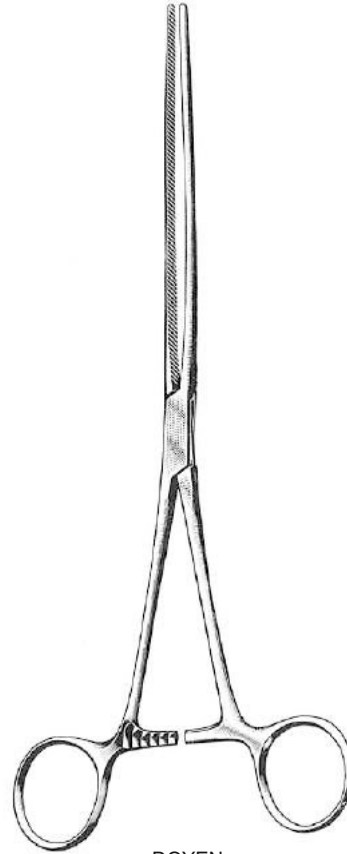

DOYEN
SF-01-10608

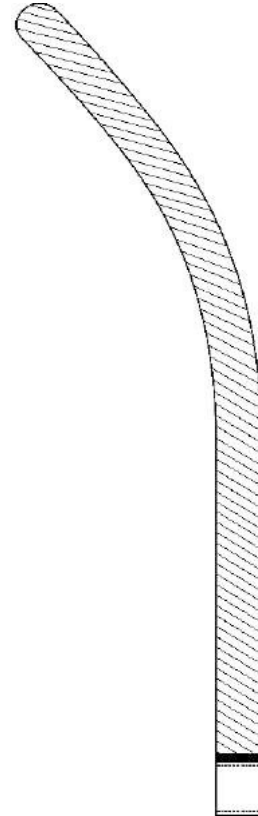

SF-01-10609
23 cm / 9"

Atraumatic

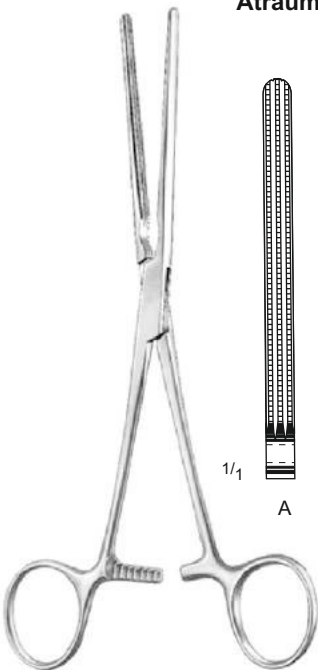

DOYEN ATRAUMA
SF-01-10610

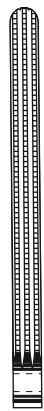

A

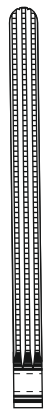

B

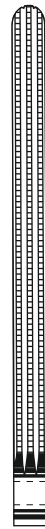

C

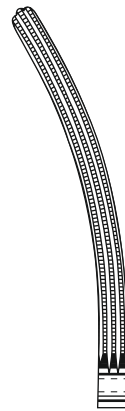

D

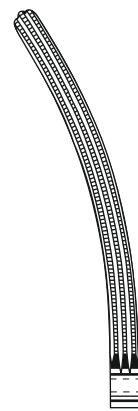

E

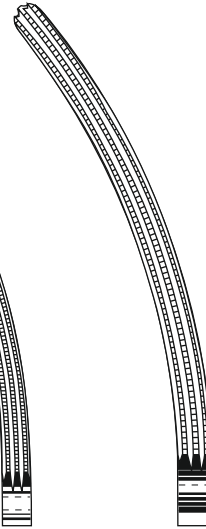

F

	13 cm / 5 ¹ / ₄ "	16 cm / 6 ¹ / ₄ "	18 cm / 7"
A.	SF-01-10611	B. SF-01-10613	C. SF-01-10615
D.	SF-01-10612	E. SF-01-10614	F. SF-01-10616

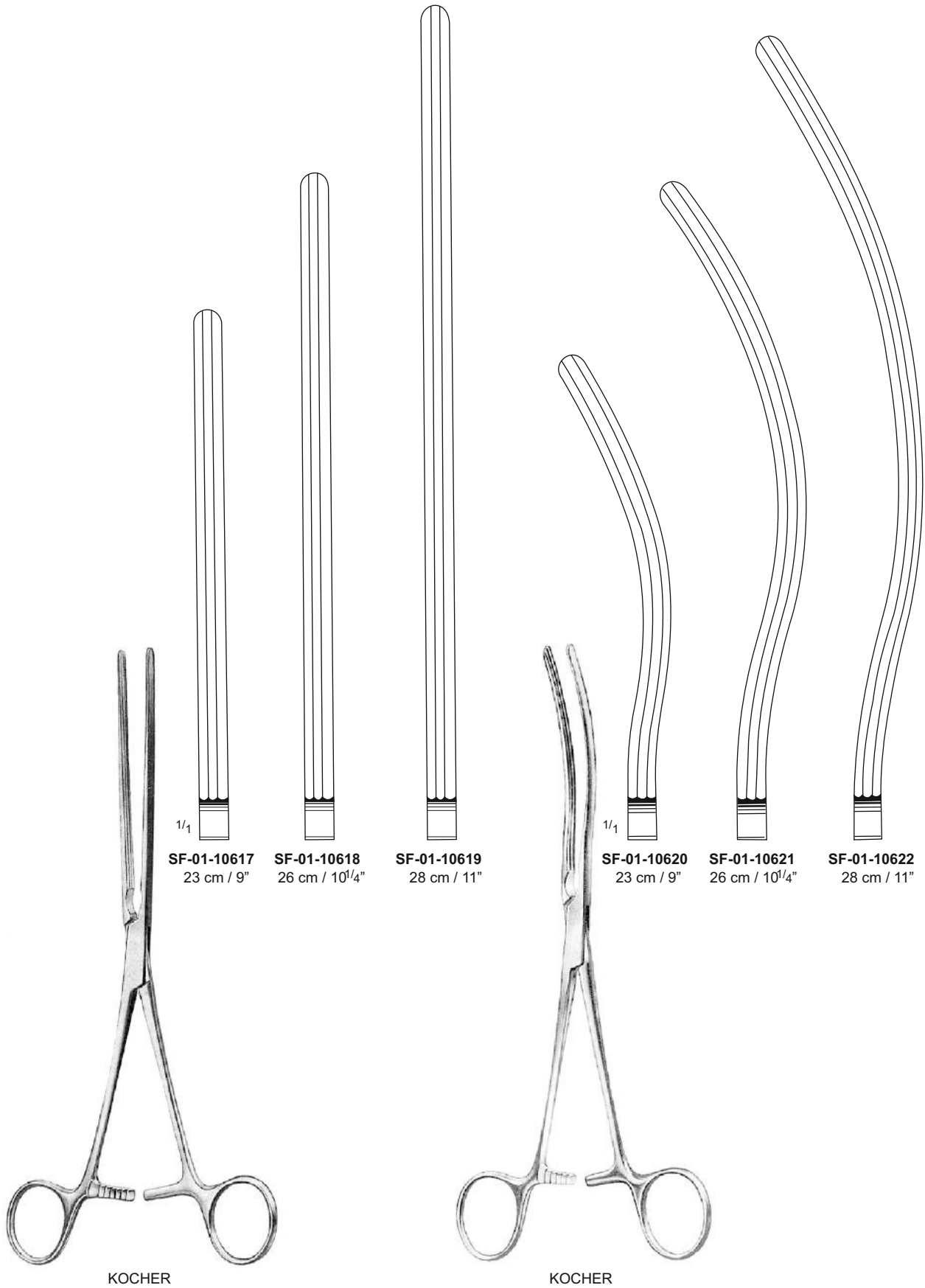

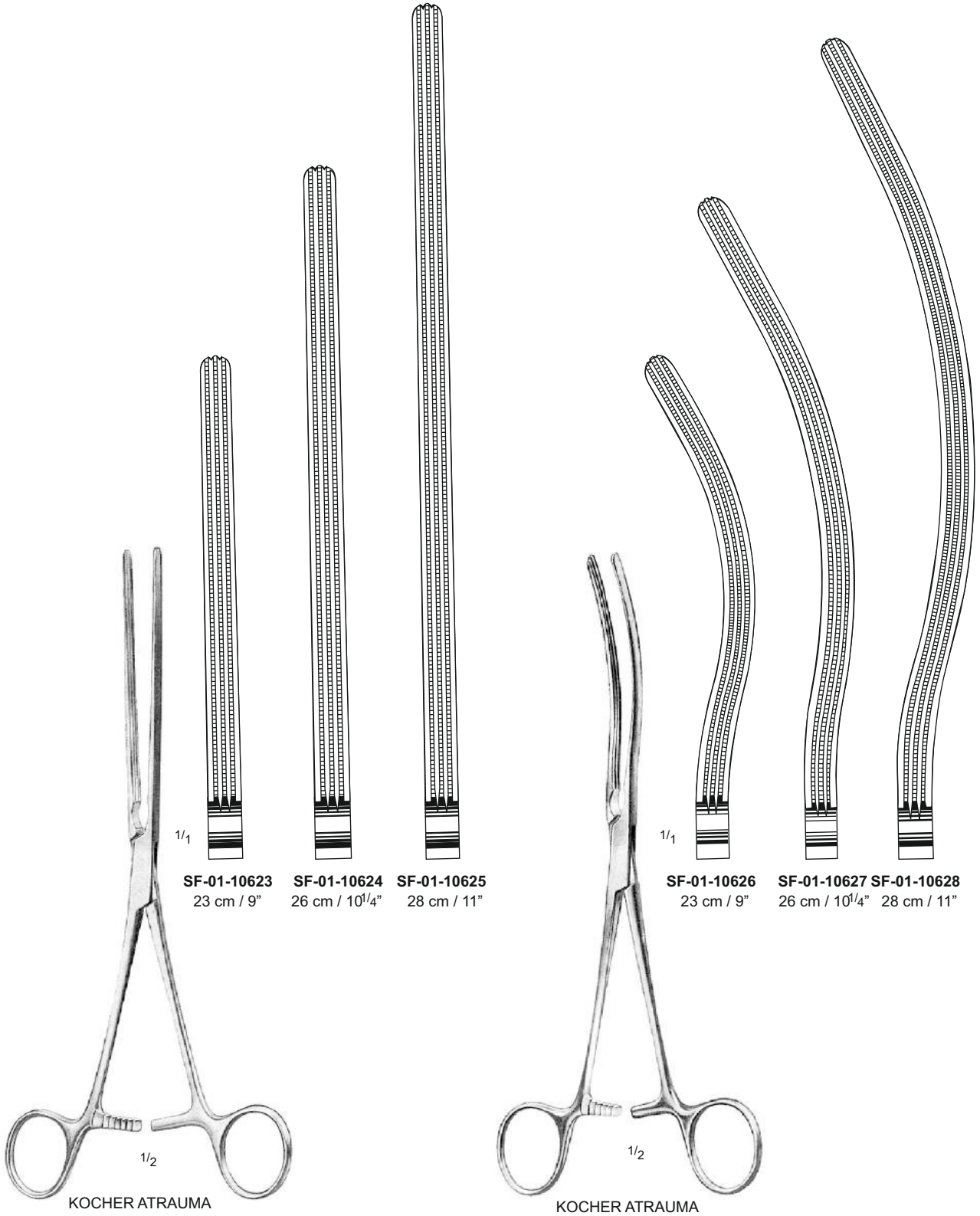

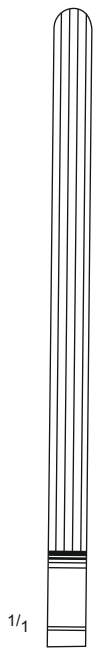

SF-01-10629
21 cm / 8¹/₄"

SF-01-10630
23 cm / 9"

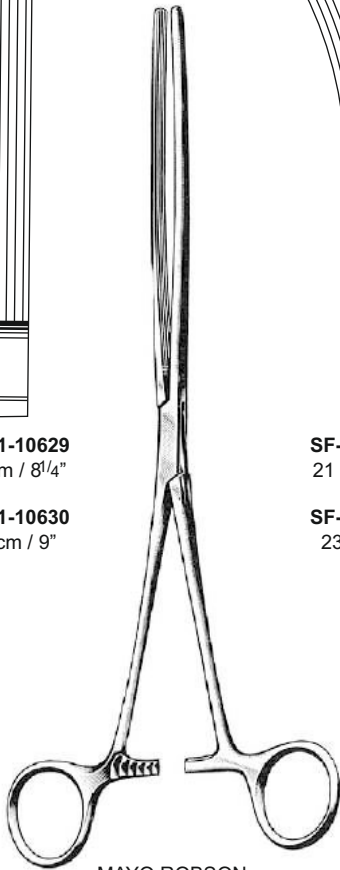

MAYO ROBSON



SF-01-10631
21 cm / 8¹/₄"

SF-01-10632
23 cm / 9"



SF-01-10633
25 cm / 10"

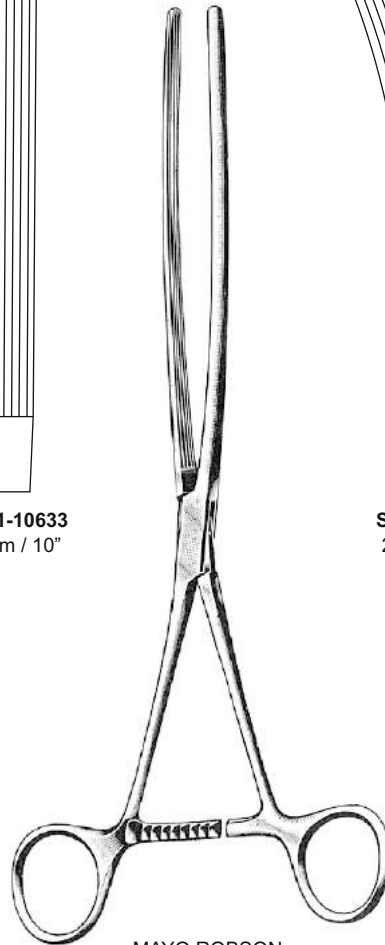

MAYO ROBSON

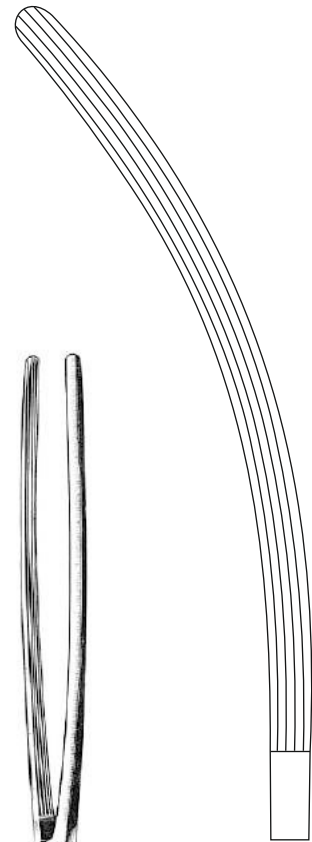

SF-01-10634
25 cm / 10"

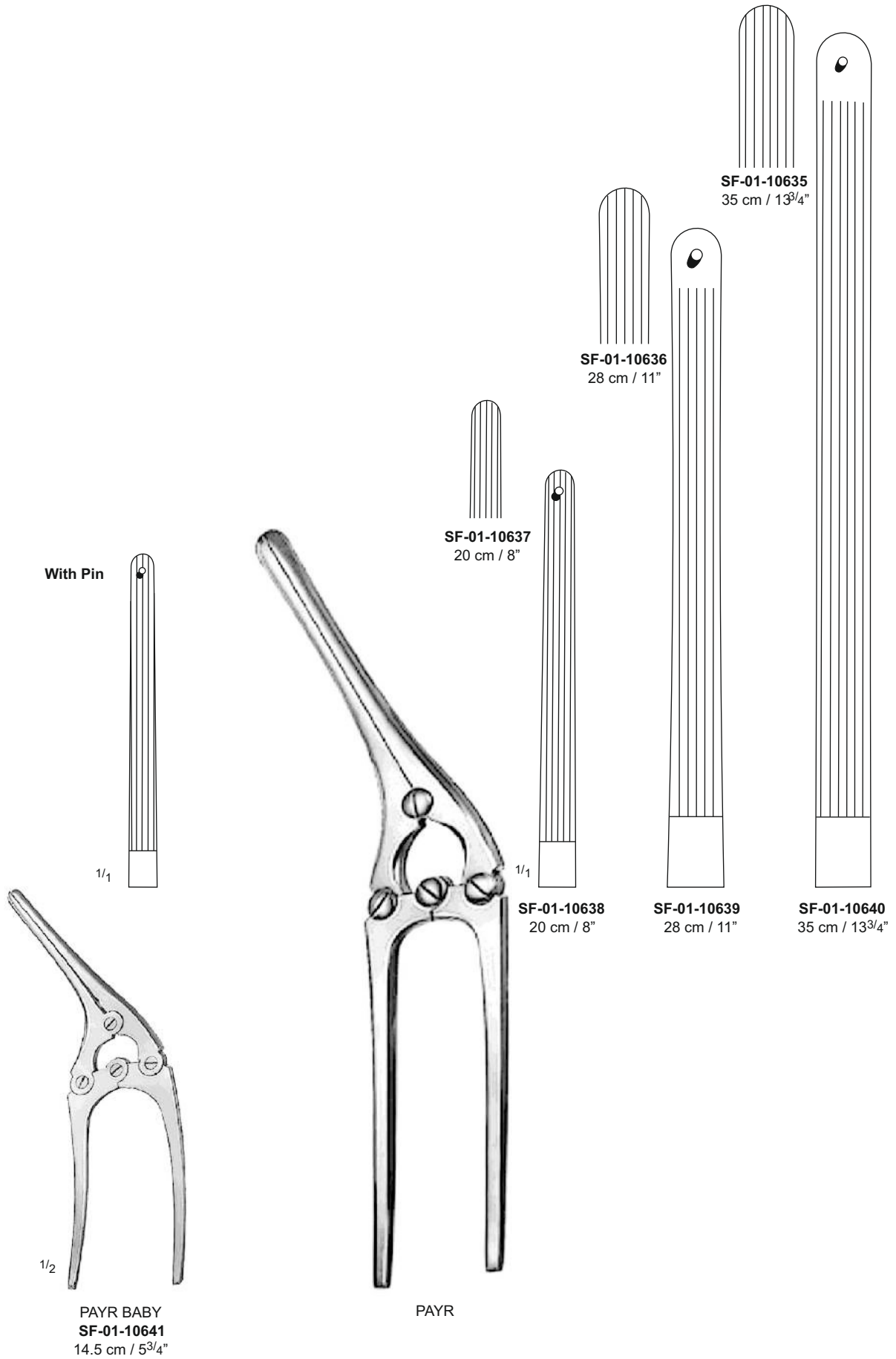

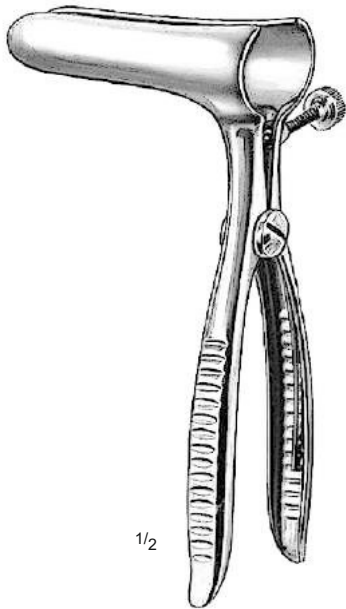

1/2

SIMS
SF-01-10642
16 cm / 6¹/₄"



1/2

SIMS
SF-01-10643
16 cm / 6¹/₄"

3 Blades



1/2

MATHIEU
SF-01-10644
21 cm / 8¹/₄"

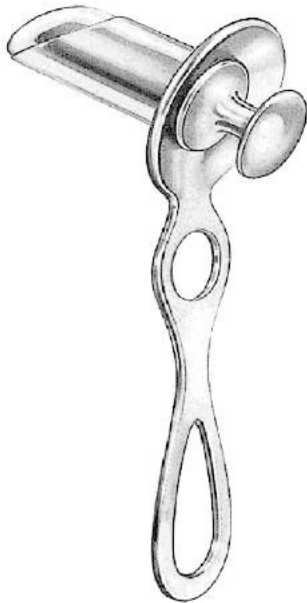

HIRSCHMANN

- SF-01-10645 – ø 16 mm x 60 mm
- SF-01-10646 – ø 19 mm x 70 mm
- SF-01-10647 – ø 22 mm x 90 mm

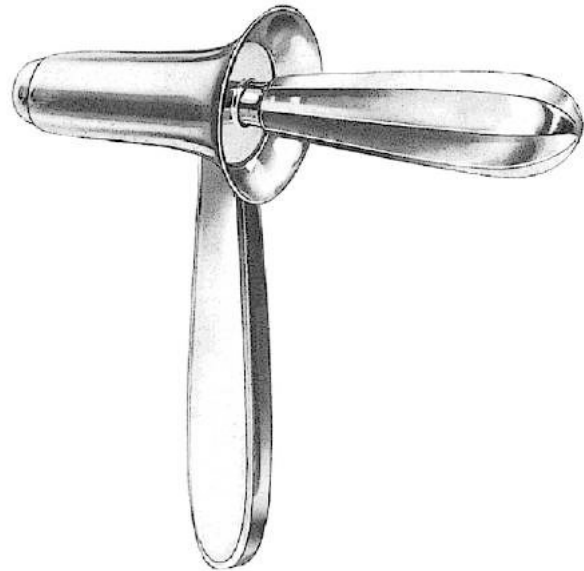

KELLY

- SF-01-10648 – ø 21 mm x 50 mm
- SF-01-10649 – ø 25 mm x 50 mm

- SF-01-10650 – ø 23 mm x 145 mm
- SF-01-10651 – ø 23 mm x 205 mm



NEWMAN

- SF-01-10652 – ø 16 mm x 63 mm
- SF-01-10653 – ø 19 mm x 63 mm
- SF-01-10654 – ø 23 mm x 63 mm

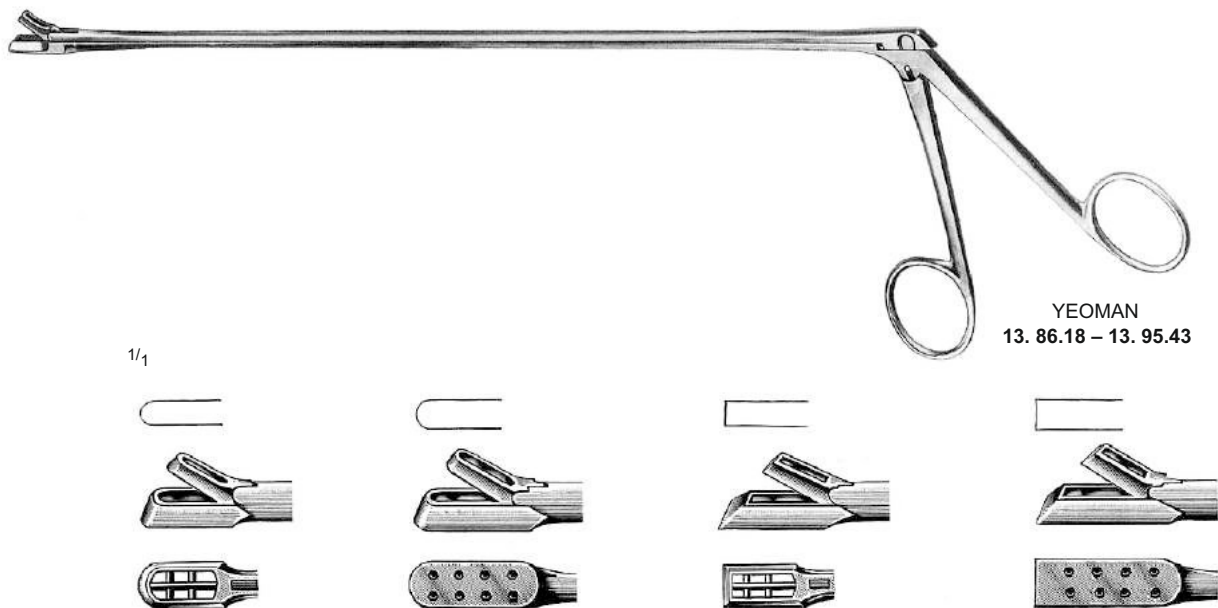
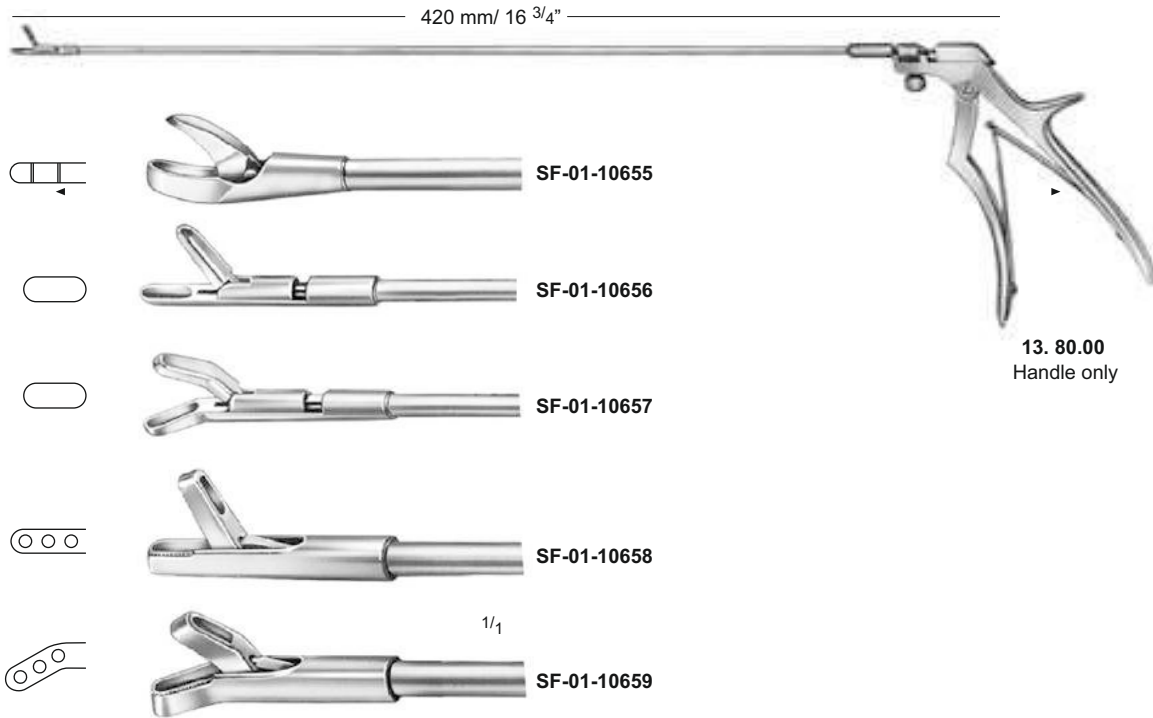

Shaft length	SF-01-10660	SF-01-10663	SF-01-10666	SF-01-10669
28 cm / 11"	SF-01-10660	SF-01-10663	SF-01-10666	SF-01-10669
35 cm / 13 ³ / ₄ "	SF-01-10661	SF-01-10664	SF-01-10667	SF-01-10670
43 cm / 17"	SF-01-10662	SF-01-10665	SF-01-10668	SF-01-10671

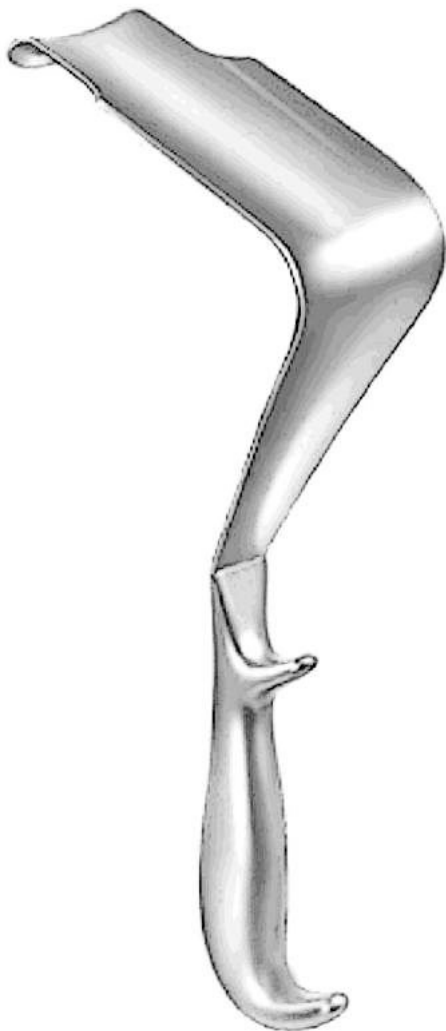

ST. MARKS
(LLOYD DAVIS)

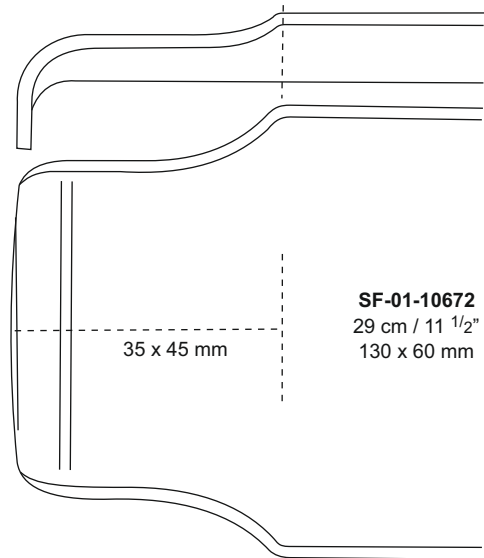

SF-01-10672
29 cm / 11 1/2"
130 x 60 mm

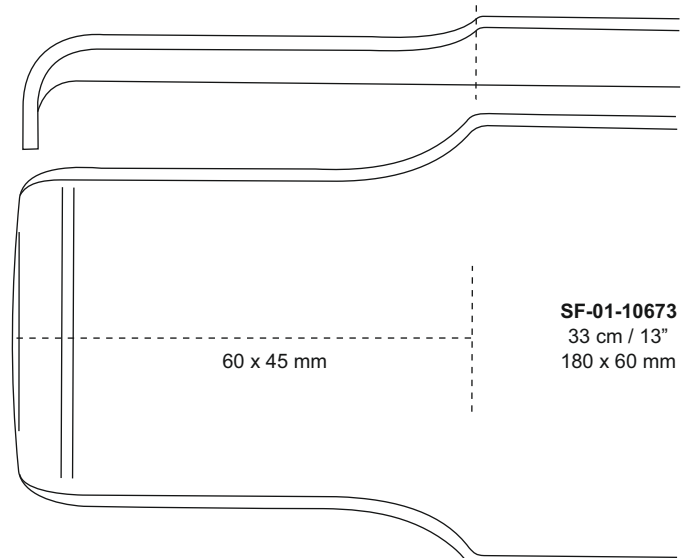

SF-01-10673
33 cm / 13"
180 x 60 mm

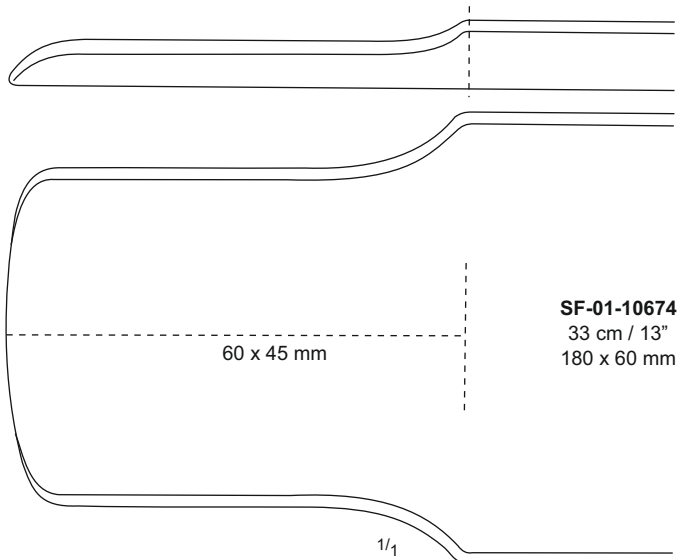

SF-01-10674
33 cm / 13"
180 x 60 mm

1/4

Gynecology

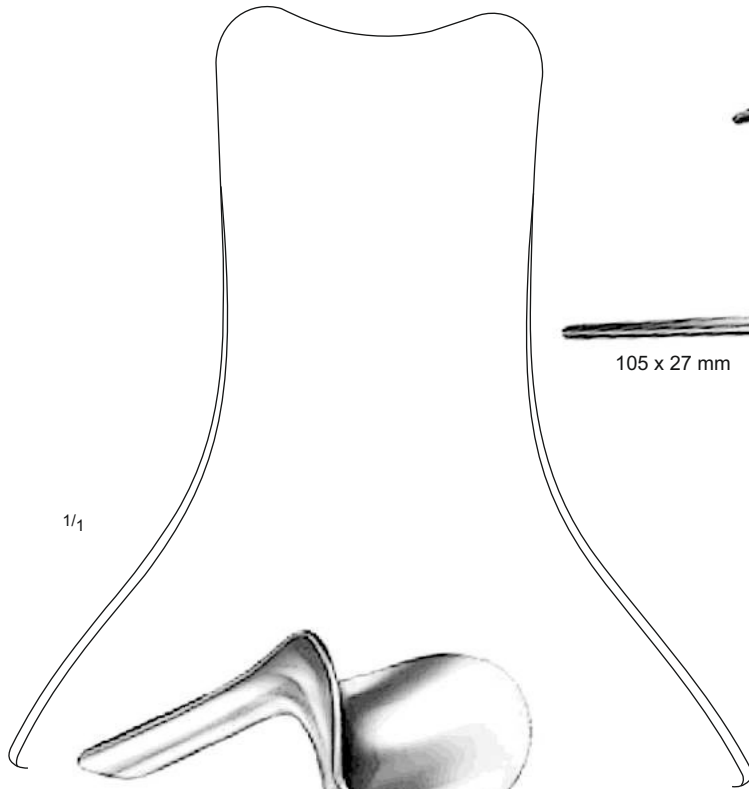

1/4

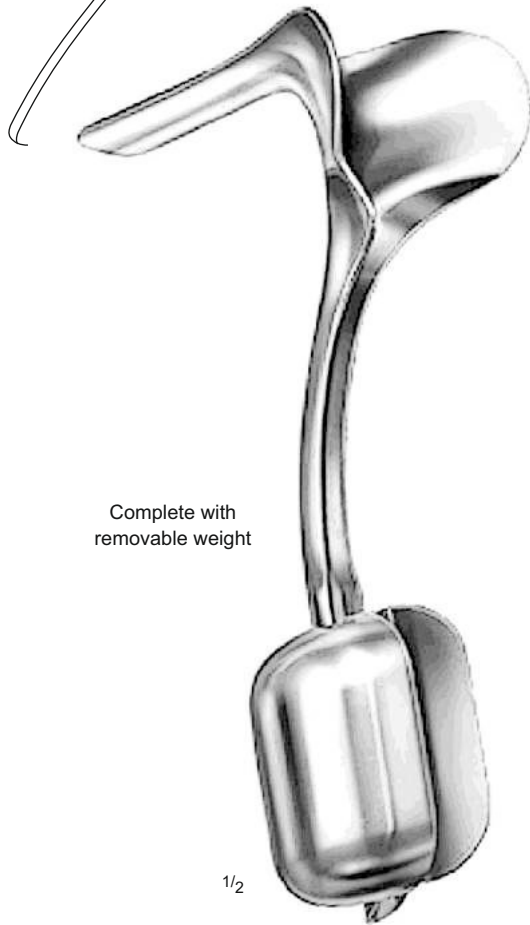

Complete with
removable weight

1/2

AUVARD
SF-01-10678
24 cm / 9 1/2"

105 x 27 mm

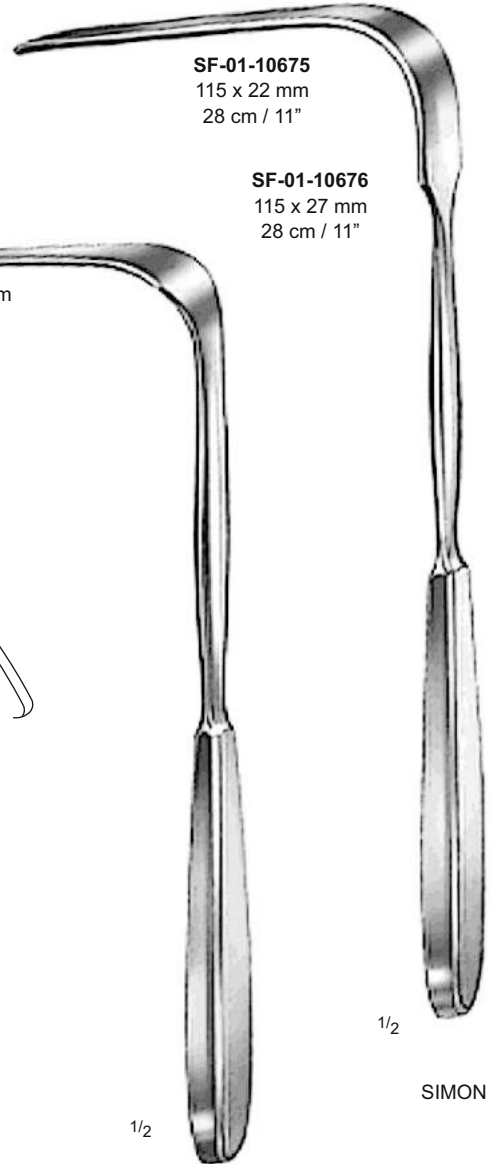

SF-01-10675
115 x 22 mm
28 cm / 11"

SF-01-10676
115 x 27 mm
28 cm / 11"

1/2

MARTIN
SF-01-10677
25 cm / 10"

1/2

SIMON

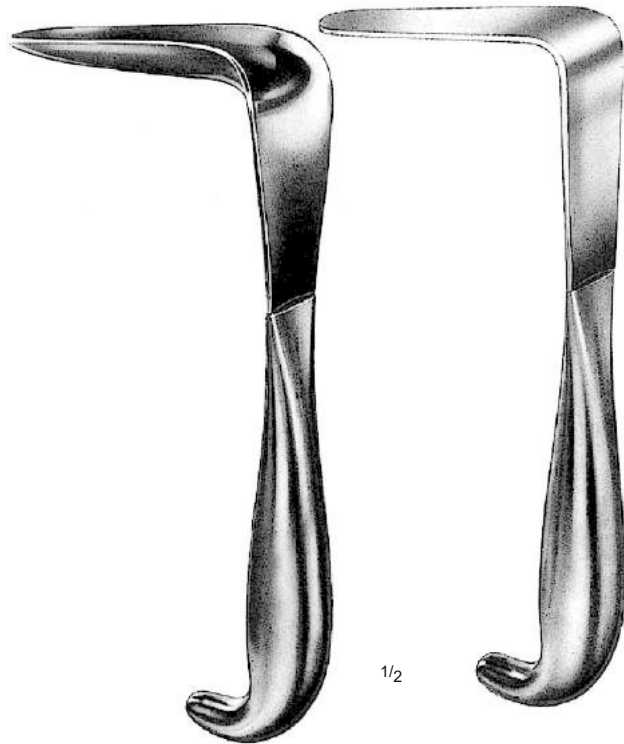

MATHIEU
SF-01-10679 – 95 x 16 - 26 mm
SF-01-10680 – 95 x 16 - 30 mm
 Vaginal Specula

MATHIEU
SF-01-10681 – 100 x 11 - 20 mm
SF-01-10682 – 100 x 14 - 26 mm
 Vaginal Retractor



KRISTELLER
 Set of one Speculum
 and one Retractor
SF-01-10686 – Fig. 1
SF-01-10687 – Fig. 2
SF-01-10688 – Fig. 3

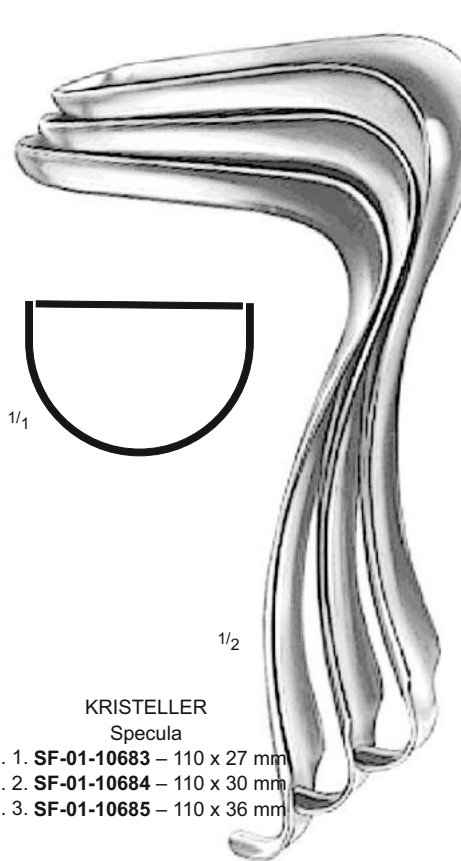

KRISTELLER
 Specula
 Fig. 1. **SF-01-10683** – 110 x 27 mm
 Fig. 2. **SF-01-10684** – 110 x 30 mm
 Fig. 3. **SF-01-10685** – 110 x 36 mm

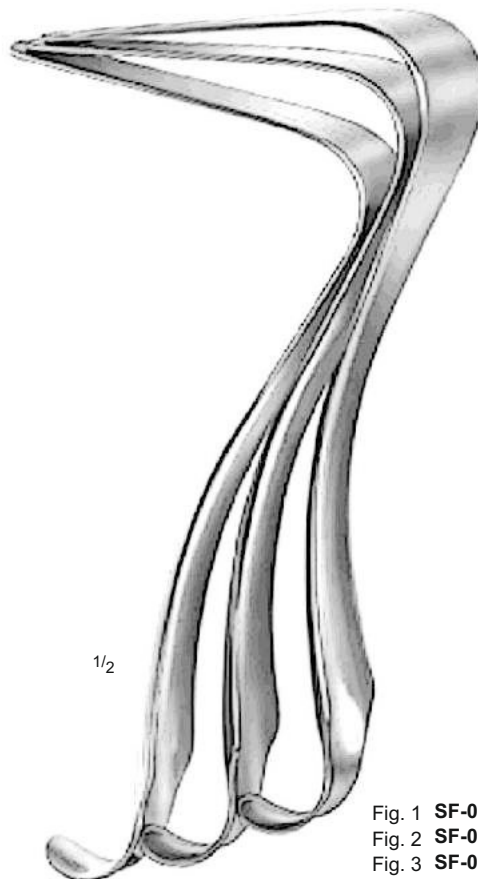

KRISTELLER
 Retractors
 Fig. 1 **SF-01-10689** – 115 x 23 mm
 Fig. 2 **SF-01-10690** – 115 x 26 mm
 Fig. 3 **SF-01-10691** – 115 x 32 mm

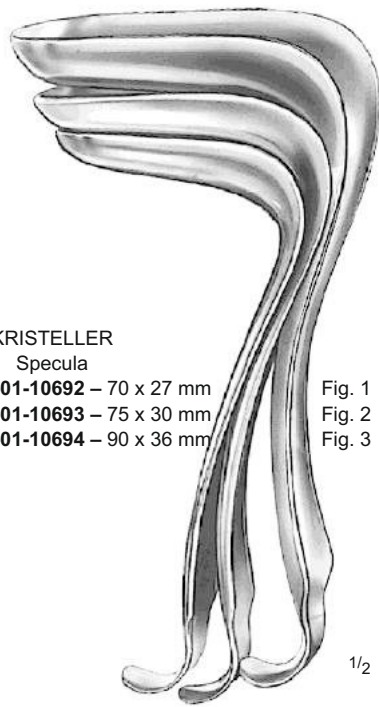

KRISTELLER
Specula

- Fig. 1 **SF-01-10692** – 70 x 27 mm
Fig. 2 **SF-01-10693** – 75 x 30 mm
Fig. 3 **SF-01-10694** – 90 x 36 mm

1/2

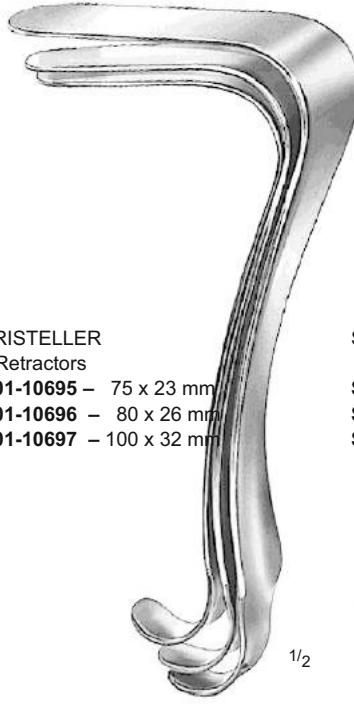

KRISTELLER
Retractors

- Fig. 1 **SF-01-10695** – 75 x 23 mm
Fig. 2 **SF-01-10696** – 80 x 26 mm
Fig. 3 **SF-01-10697** – 100 x 32 mm

1/2



KRISTELLER
Set of 1 Speculum and
1 Retractor each

- SF-01-10698** – Fig. 1
SF-01-10699 – Fig. 2
SF-01-10700 – Fig. 3

1/2

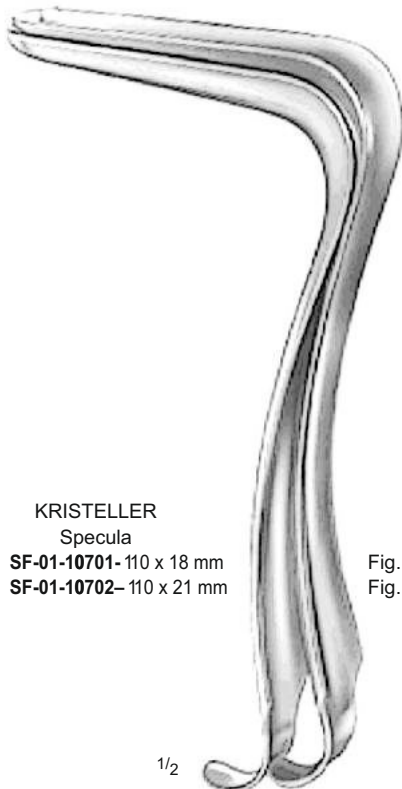

KRISTELLER
Specula

- Fig. 1 **SF-01-10701**– 110 x 18 mm
Fig. 2 **SF-01-10702**– 110 x 21 mm

1/2

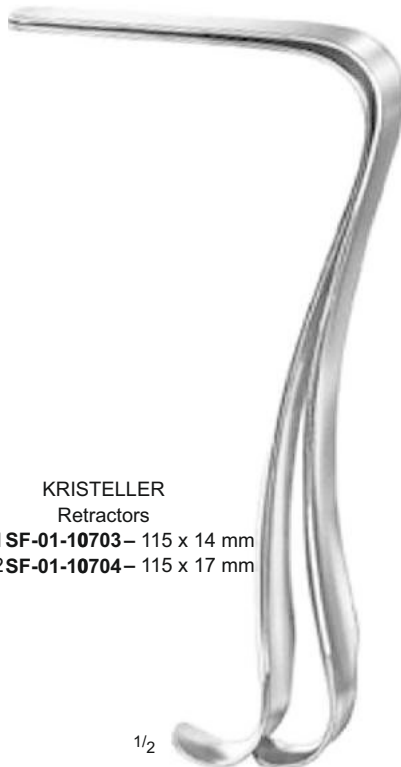

KRISTELLER
Retractors

- Fig. 1 **SF-01-10703**– 115 x 14 mm
Fig. 2 **SF-01-10704**– 115 x 17 mm

1/2



KRISTELLER
Set of 1 Speculum
and 1 Retractor each

- SF-01-10705**– Fig. 1
SF-01-10706– Fig. 2

1/2

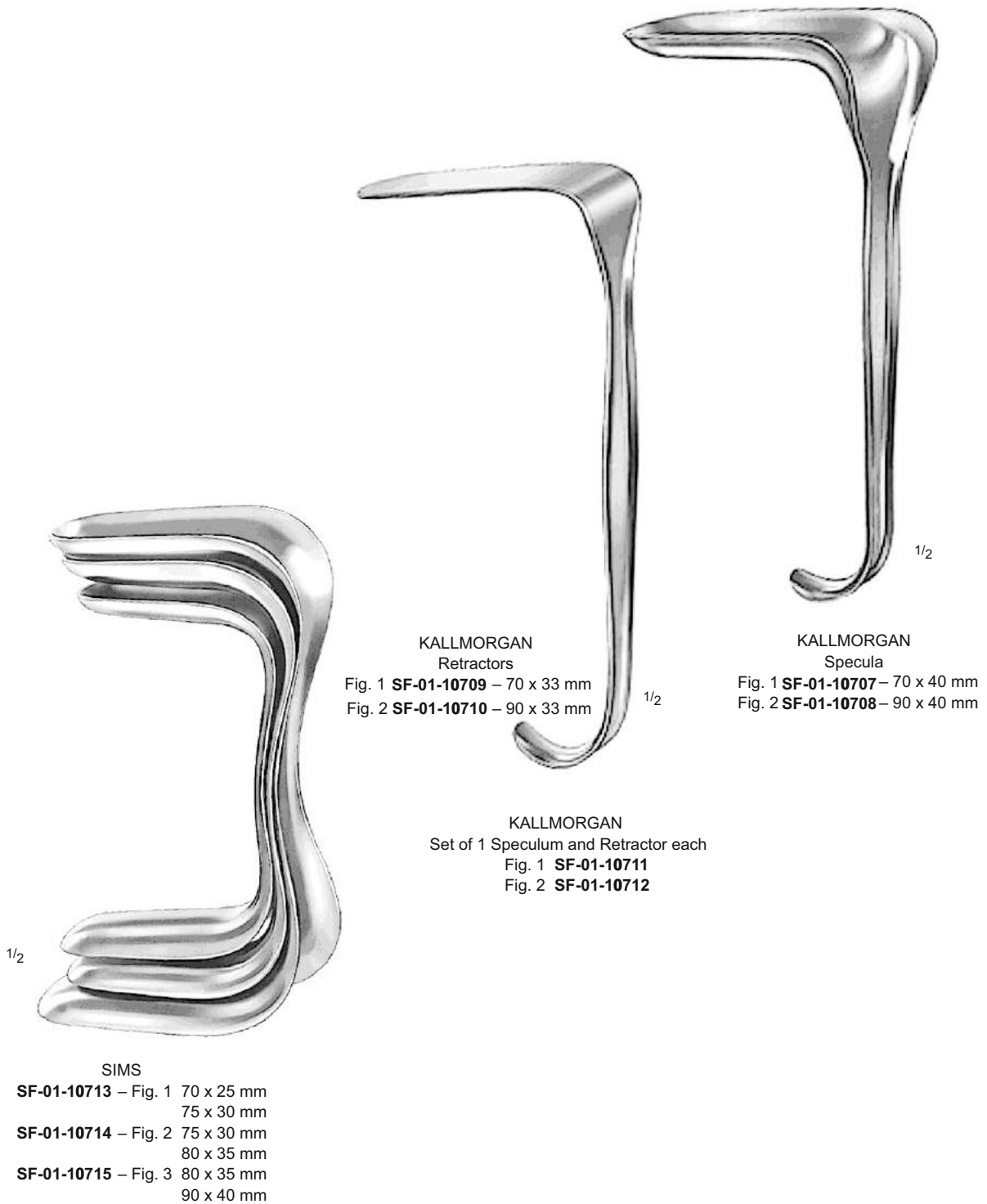

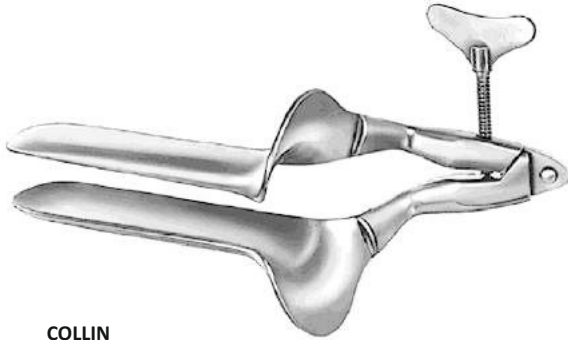

COLLIN

- SF-01-10716 – 90 x 25 mm
- SF-01-10717 – 90 x 29 mm
- SF-01-10718 – 100 x 35 mm
- SF-01-10719 – 100 x 40 mm
- SF-01-10720 – 110 x 36 mm
- SF-01-10721 – 110 x 40 mm

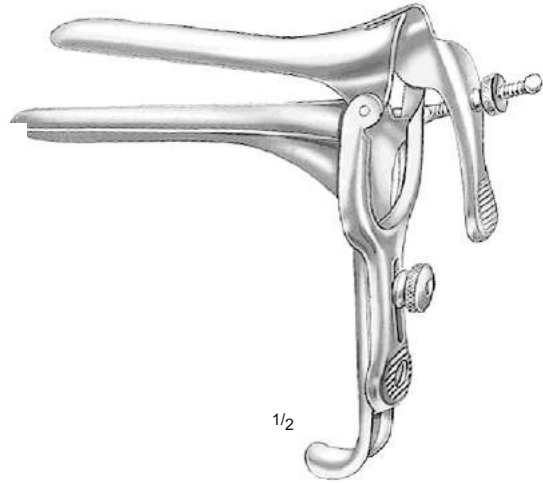

PEDERSON

- SF-01-10722 – 76 x 13 mm
- SF-01-10723 – 100 x 22 mm
- SF-01-10724 – 120 x 25 mm



60 x 30 mm

- SF-01-10728 – 100 x 20 mm
- SF-01-10729 – 100 x 25 mm
- SF-01-10730 – 100 x 30 mm
- SF-01-10731 – 100 x 35 mm
- SF-01-10732 – 100 x 40 mm
- SF-01-10733 – 130 x 20 mm
- SF-01-10734 – 130 x 25 mm
- SF-01-10735 – 130 x 30 mm
- SF-01-10736 – 130 x 35 mm
- SF-01-10737 – 130 x 40 mm

1/2

BRIESKY

27 - 30 cm / 10^{3/4}" - 11^{3/4}"

1/3

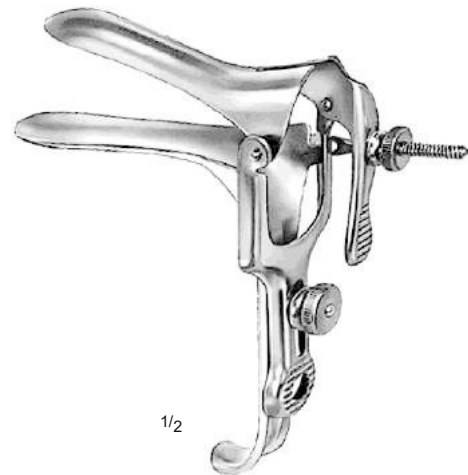

GRAVES

- SF-01-10725 – 75 x 20 mm
- SF-01-10726 – 100 x 30 mm
- SF-01-10727 – 115 x 35 mm

1/2

DOYEN
SF-01-10738
23 cm / 9"

Central Fixation Screw

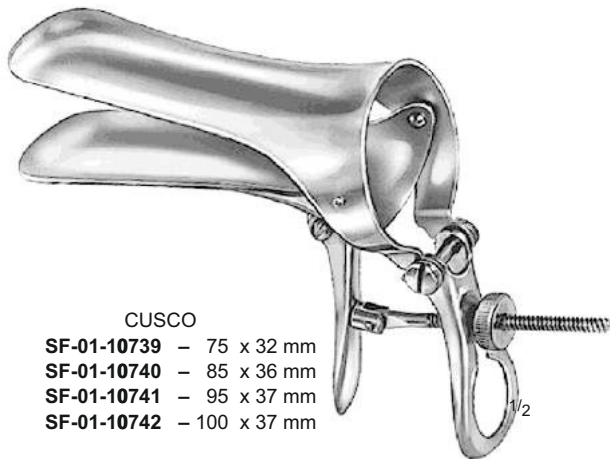

- CUSCO
- SF-01-10739 – 75 x 32 mm
 - SF-01-10740 – 85 x 36 mm
 - SF-01-10741 – 95 x 37 mm
 - SF-01-10742 – 100 x 37 mm

For Virgins

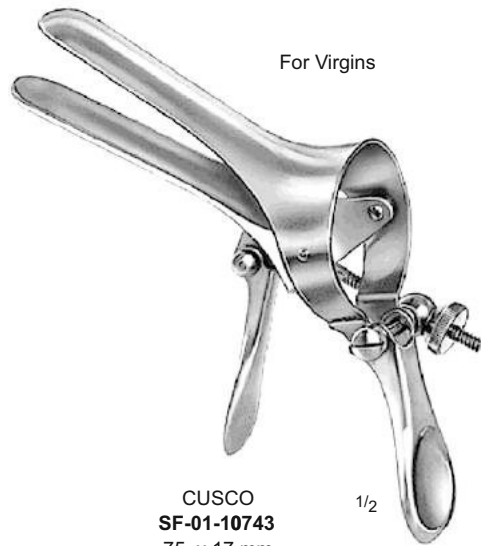

- CUSCO
SF-01-10743
75 x 17 mm

Swiss Pattern

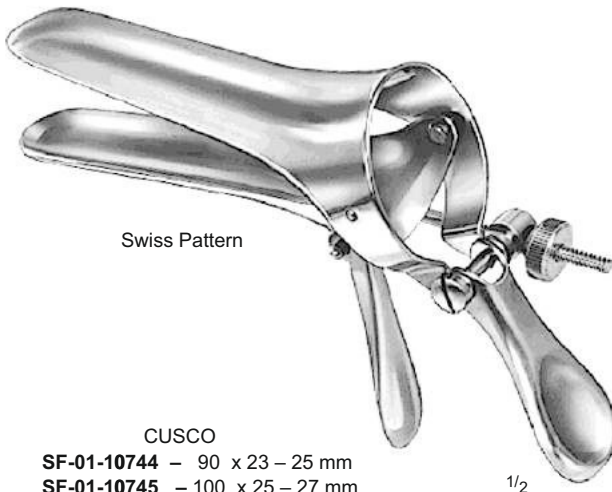

- CUSCO
- SF-01-10744 – 90 x 23 – 25 mm
 - SF-01-10745 – 100 x 25 – 27 mm
 - SF-01-10746 – 110 x 27 – 30 mm

Lateral Fixation Screw

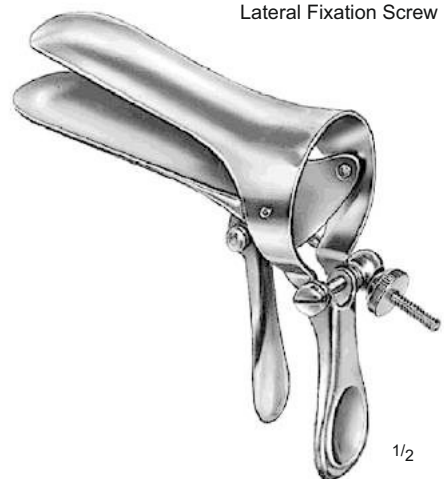

- CUSCO
- SF-01-10747 – 75 x 32 mm
 - SF-01-10748 – 85 x 36 mm
 - SF-01-10749 – 95 x 37 mm
 - SF-01-10750 – 100 x 35 mm

With Sloped Handle

mm Ø

1	SF-01-10751	
1.5		SF-01-10752
2	SF-01-10753	
2.5		SF-01-10754
3	SF-01-10755	
3.5		SF-01-10756
4	SF-01-10757	
4.5		SF-01-10758
5	SF-01-10759	
5.5		SF-01-10760
6	SF-01-10761	
6.5		SF-01-10762
7	SF-01-10763	
7.5		SF-01-10764
8	SF-01-10765	
8.5		SF-01-10766
9	SF-01-10767	
9.5		SF-01-10768
10	SF-01-10769	
10.5		SF-01-10770
11	SF-01-10771	
11.5		SF-01-10772
12	SF-01-10773	
12.5		SF-01-10774
13	SF-01-10775	
13.5		SF-01-10776
14	SF-01-10777	
14.5		SF-01-10778
15	SF-01-10779	



1/2

HEGAR



mmø

1 + 2 mm	SF-01-10780
3 + 4 mm	SF-01-10781
5 + 6 mm	SF-01-10782
7 + 8 mm	SF-01-10783
9 + 10 mm	SF-01-10784
11 + 12 mm	SF-01-10785
13 + 14 mm	SF-01-10786
15 + 16 mm	SF-01-10787
17 + 18 mm	SF-01-10788
19 + 20 mm	SF-01-10789
21 + 22 mm	SF-01-10790
23 + 24 mm	SF-01-10791
25 + 26 mm	SF-01-10792

HEGAR

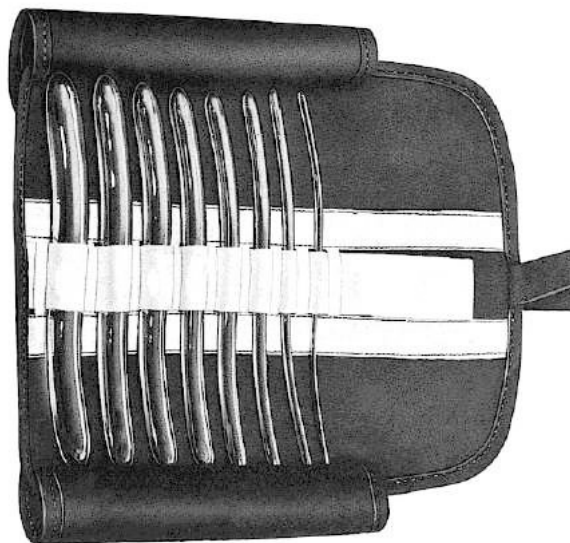
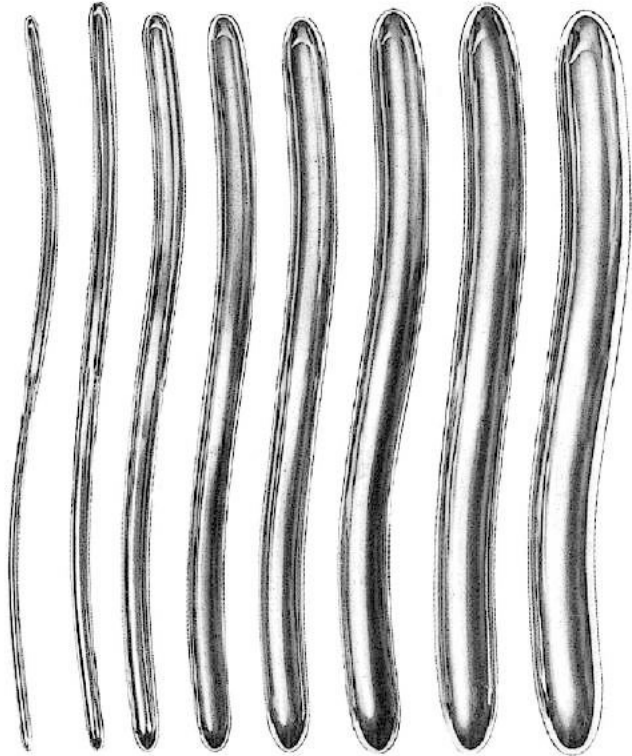

SF-01-10793
Set of 8 dilators, 3 + 4mm – 17 + 18 mm,
in canvas roll.

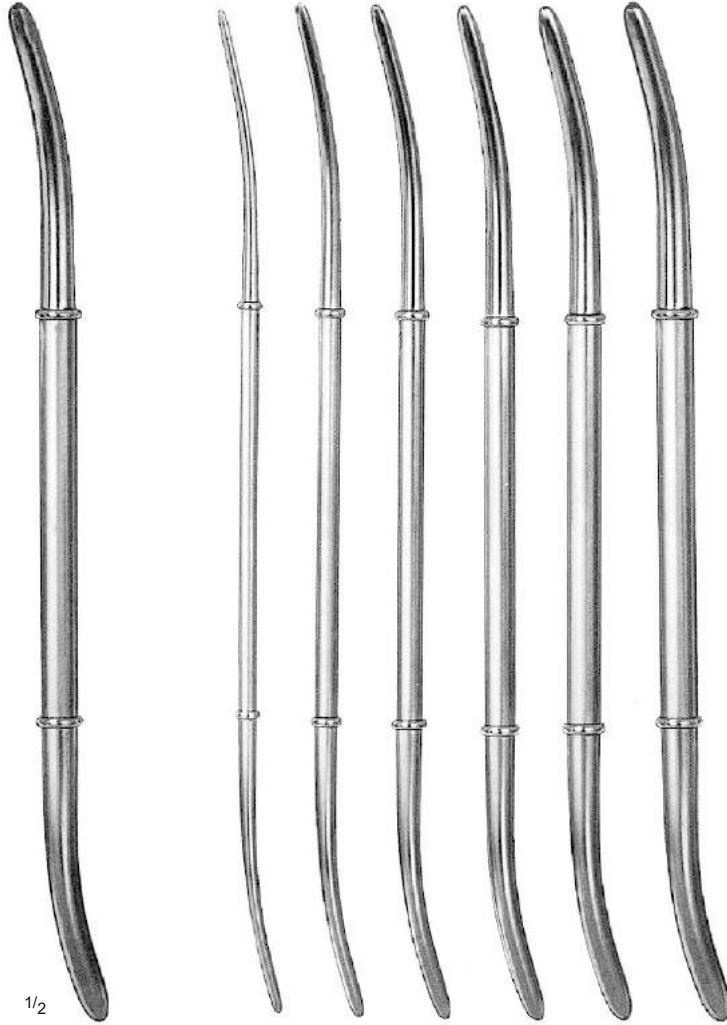

1/2

HANK

- ø mm
- SF-01-10794** – Fig. 9/10 = 4.5 / 5 mm
 - SF-01-10795** – Fig. 11/12 = 5.5 / 6 mm
 - SF-01-10796** – Fig. 13/14 = 6.5 / 7 mm
 - SF-01-10797** – Fig. 15/16 = 7.5 / 8 mm
 - SF-01-10798** – Fig. 17/18 = 8.5 / 9 mm
 - SF-01-10799** – Fig. 19/20 = 9.5 / 10 mm

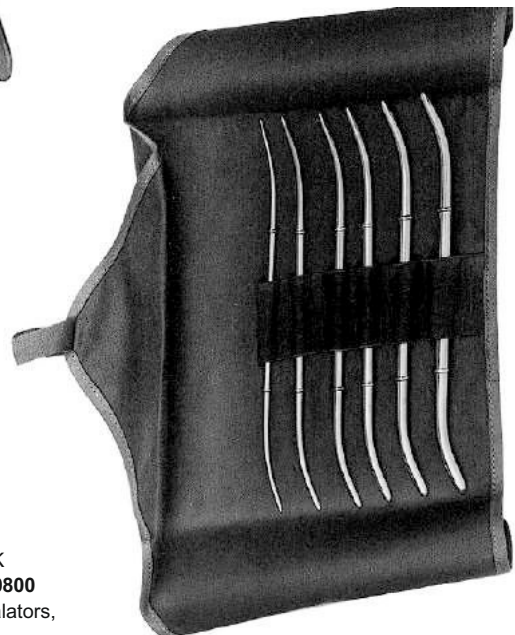

HANK
SF-01-10800
Set of 6 Dialators,

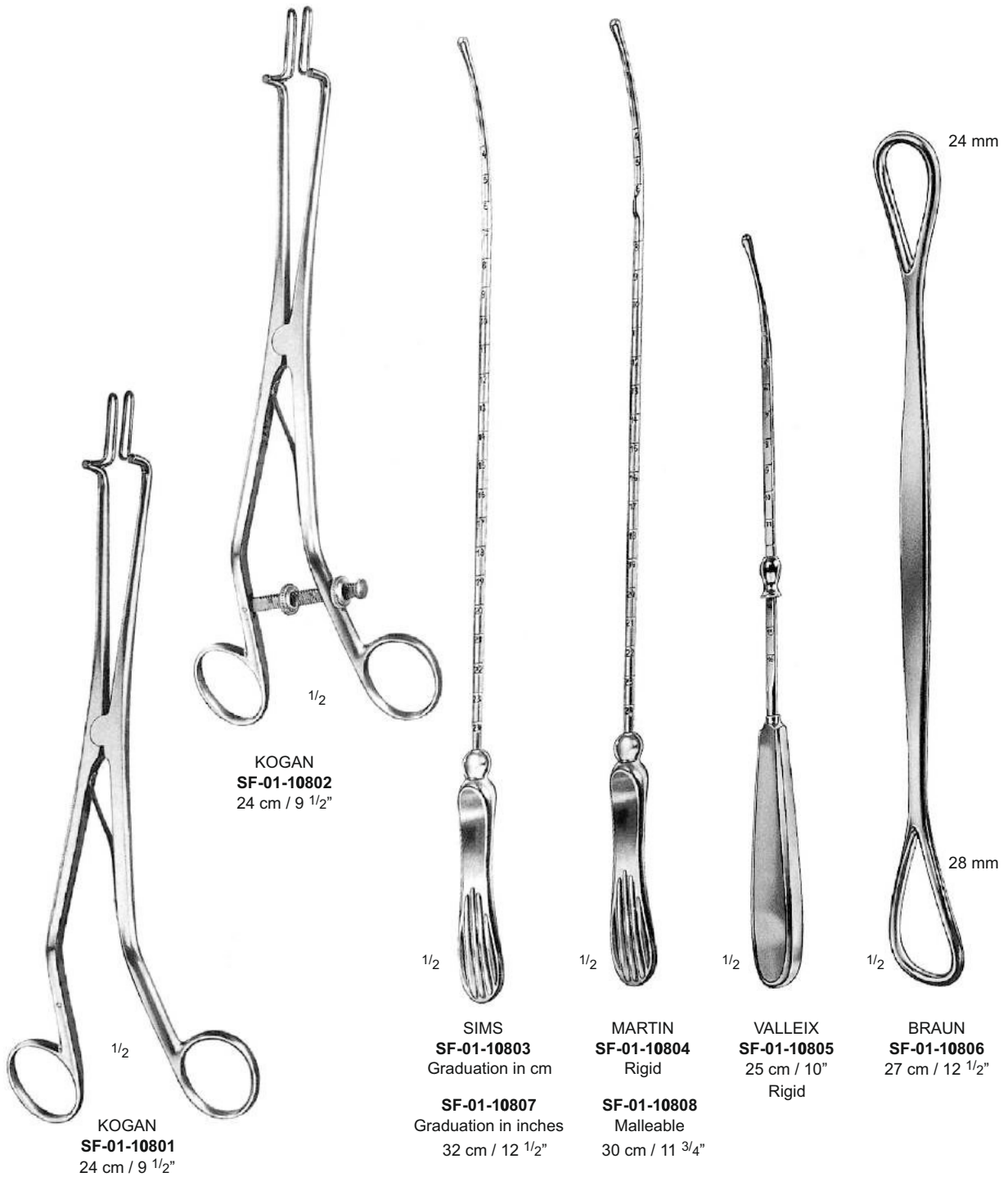

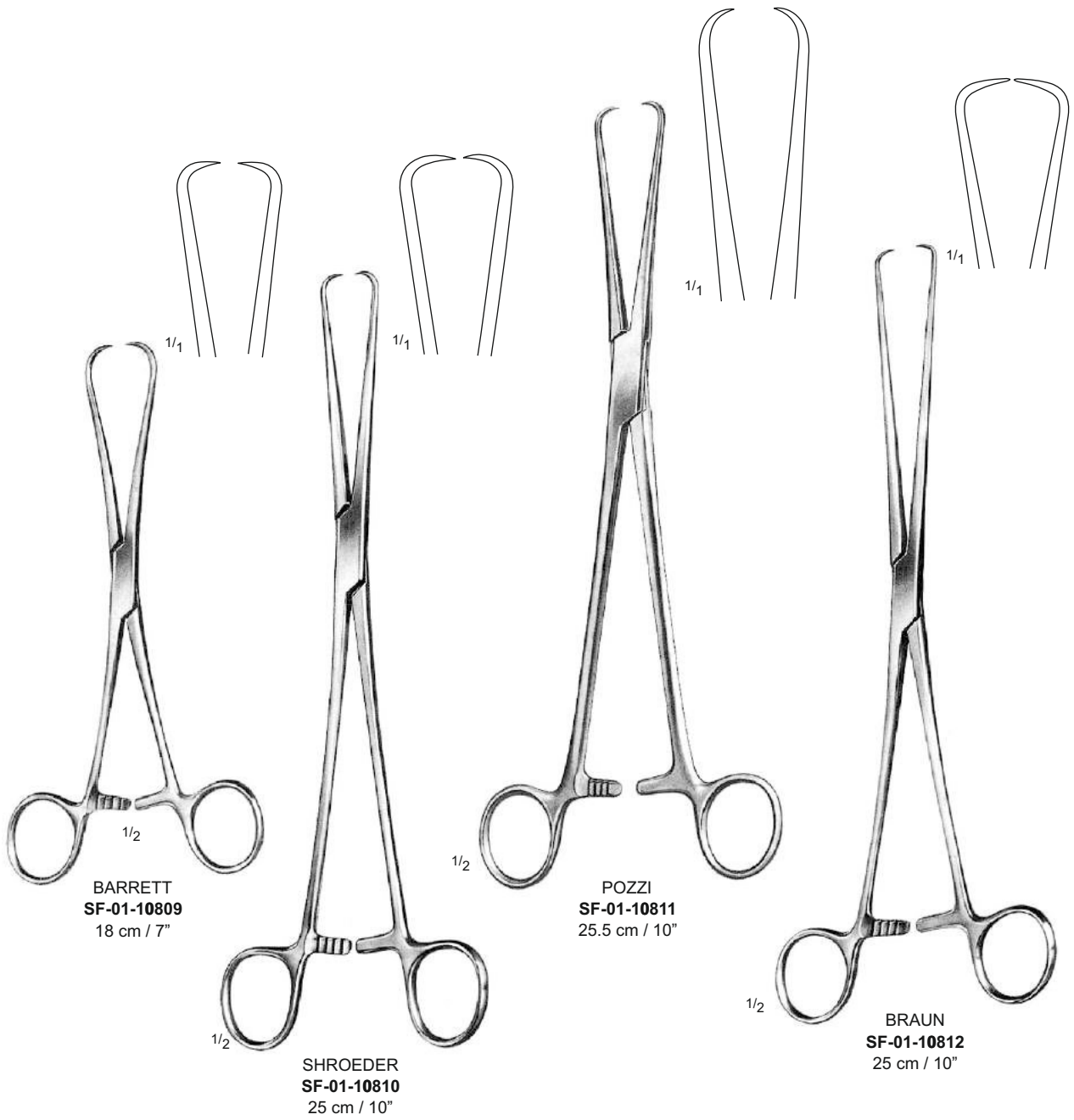

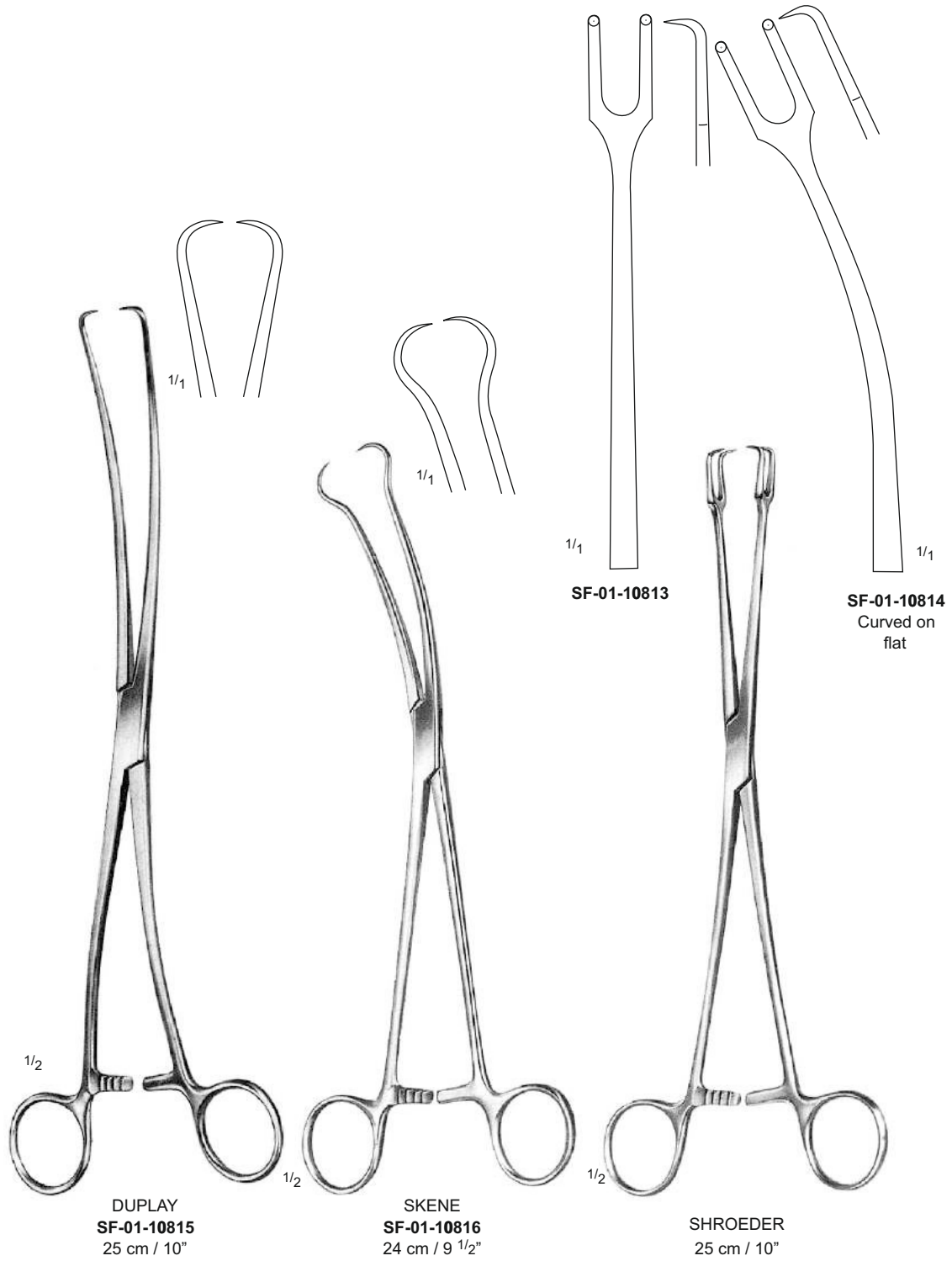

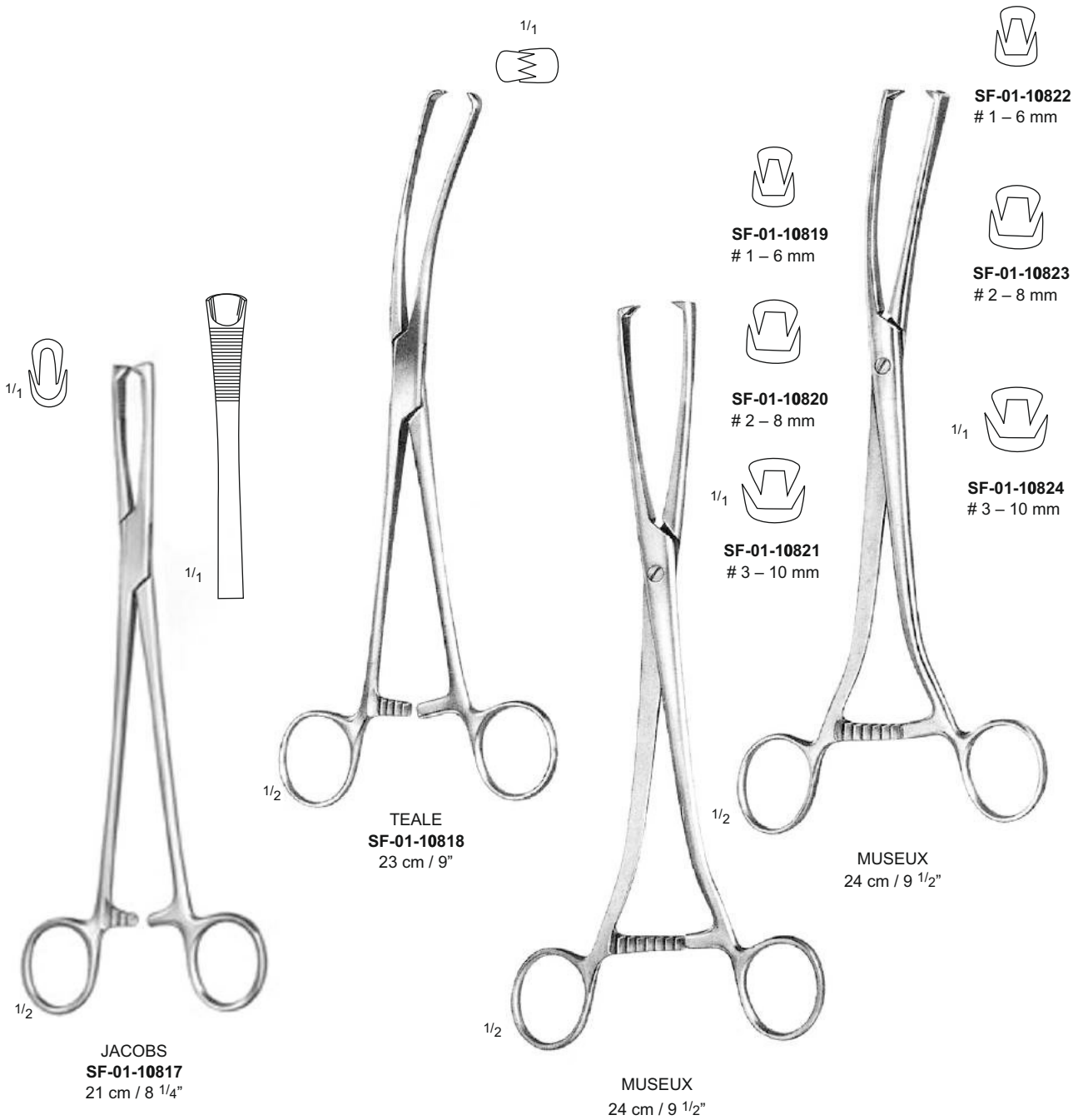

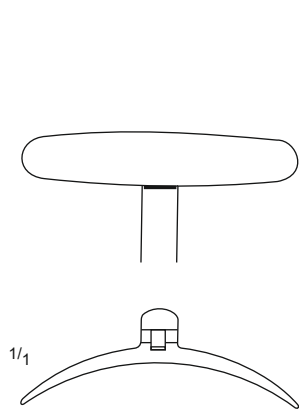

COLLIN
SF-01-10828
26 cm / 10 1/4"

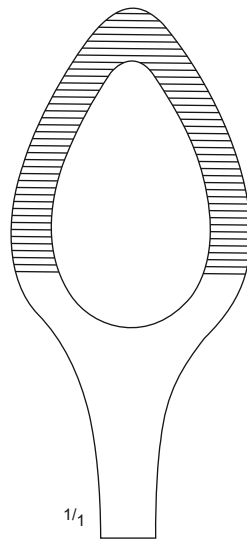

SOMER
SF-01-10829
24 cm / 9 1/2"

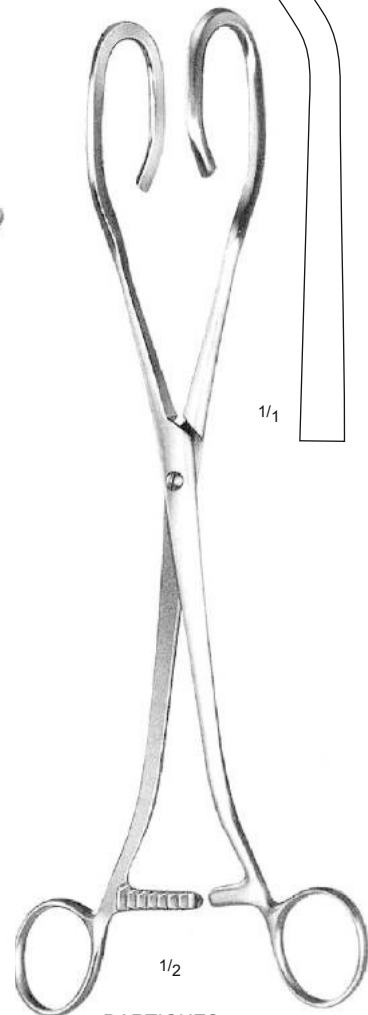
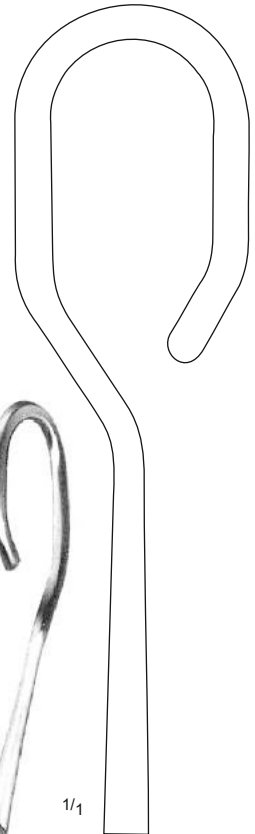

DARTIGUES
SF-01-10830
26 cm / 10 1/4"

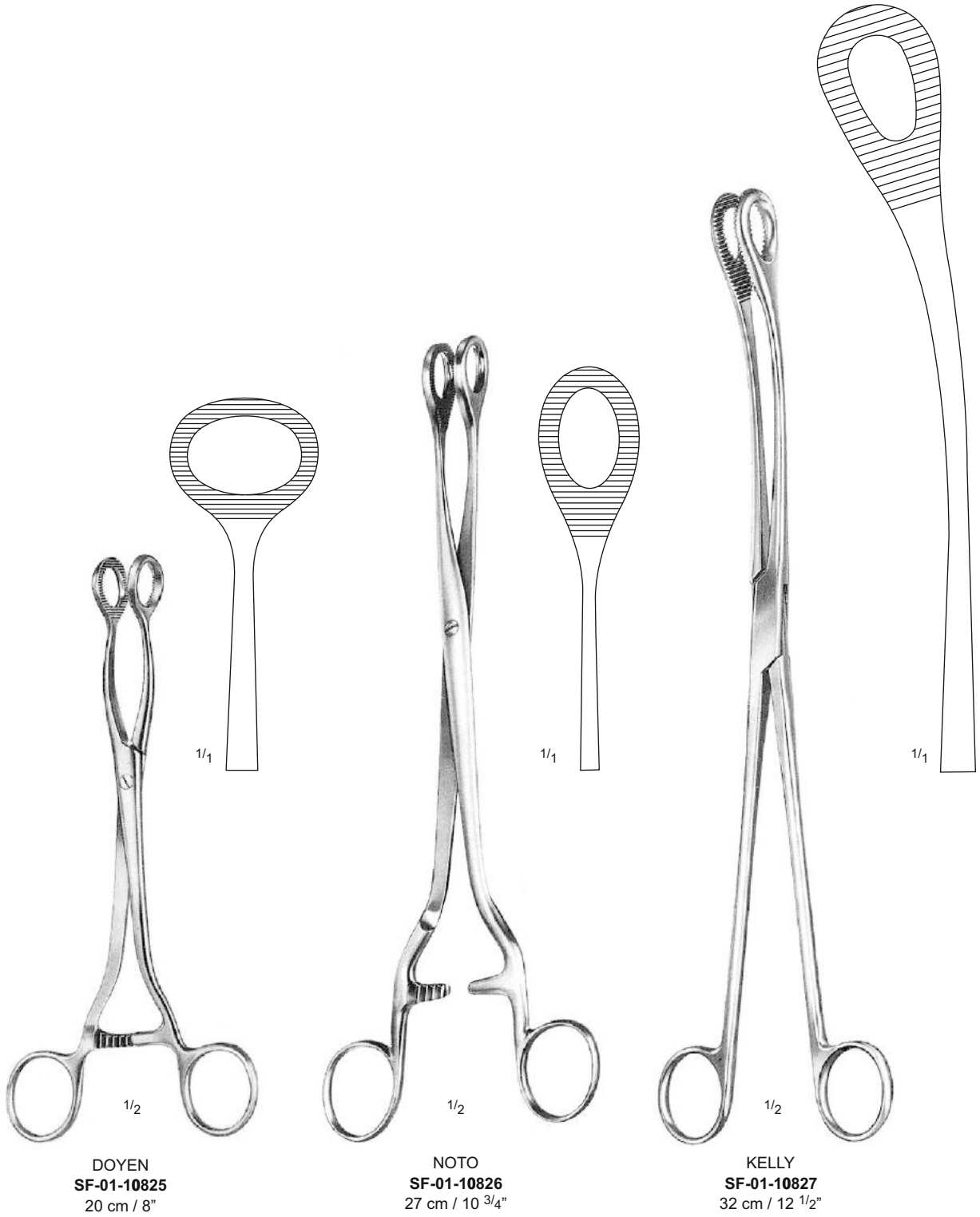



DOYEN
SF-01-10831
20 cm / 8"

NOTO
SF-01-10832
27 cm / 10 3/4"

KELLY
SF-01-10833
32 cm / 12 1/2"

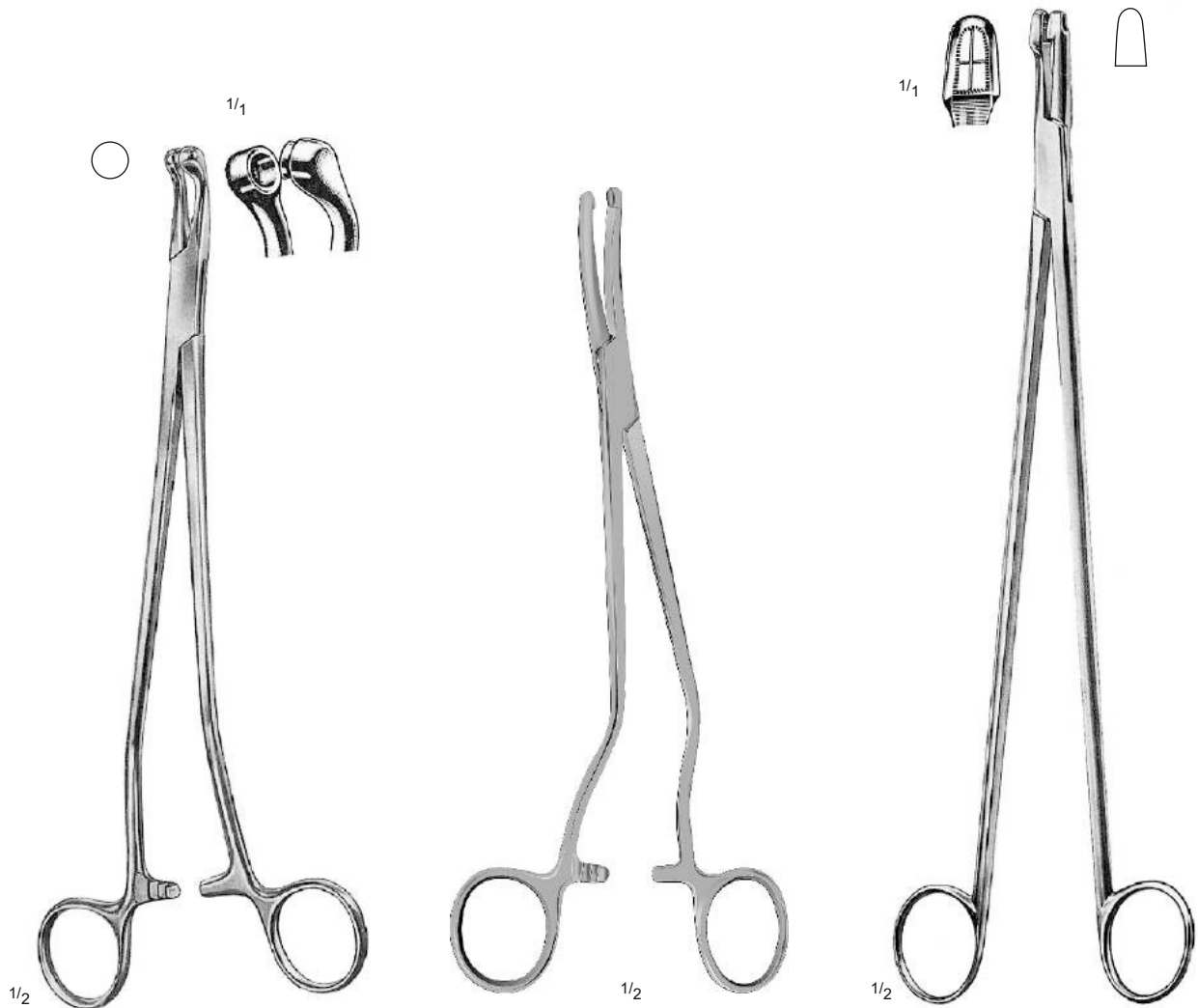

1/2
THOMS - GAYLOR
SF-01-10834
24 cm / 9 1/2"

1/2
PROFESSOR MEDINA
SF-01-10835
22 cm / 8 3/4"

1/2
SCHUBERT
SF-01-10836
21 cm / 8 1/4"

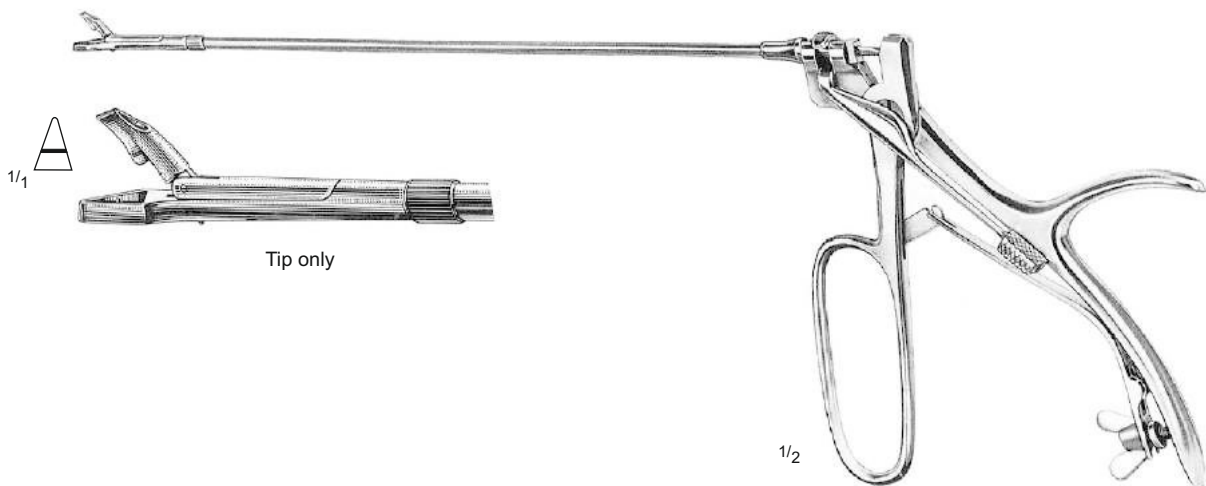

1/1
Tip only

1/2
SCHUMACHER
SF-01-10837

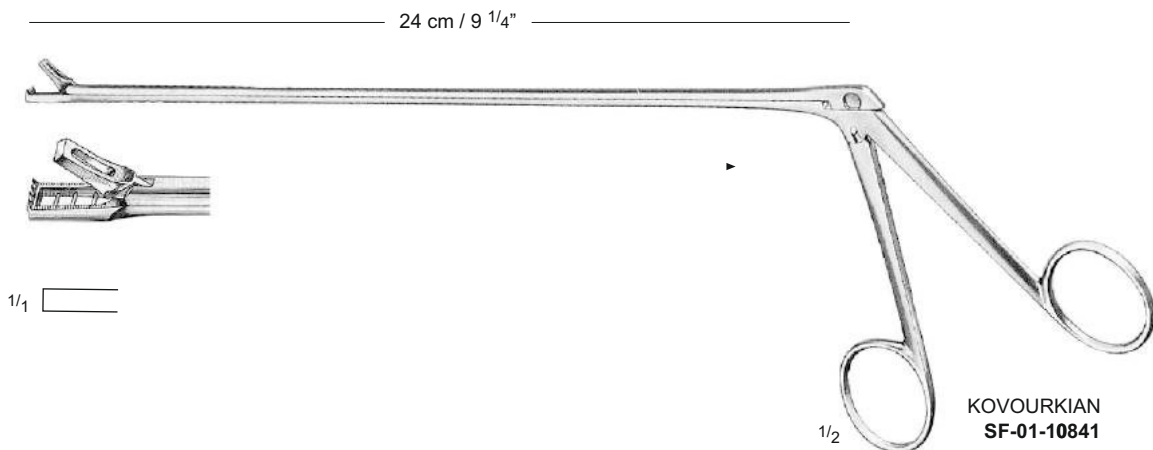
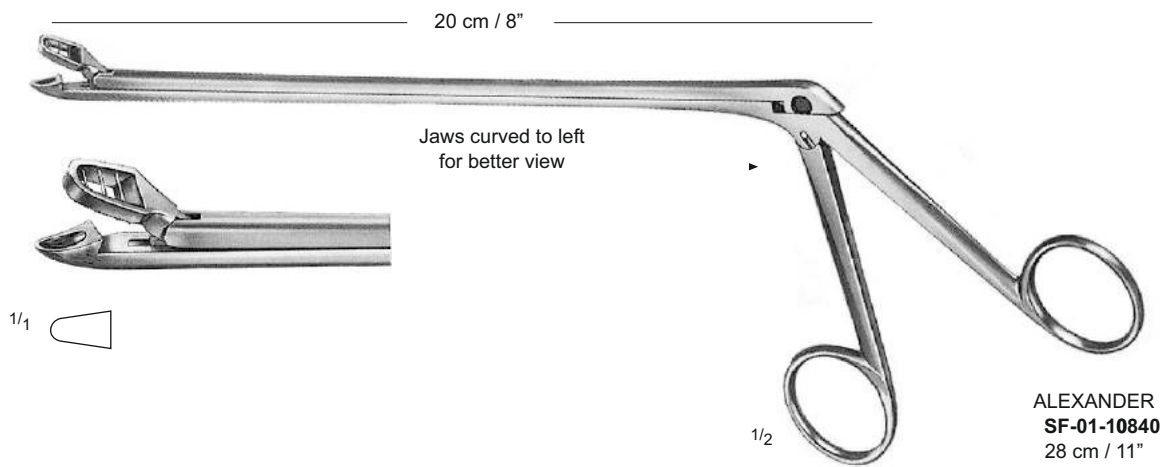
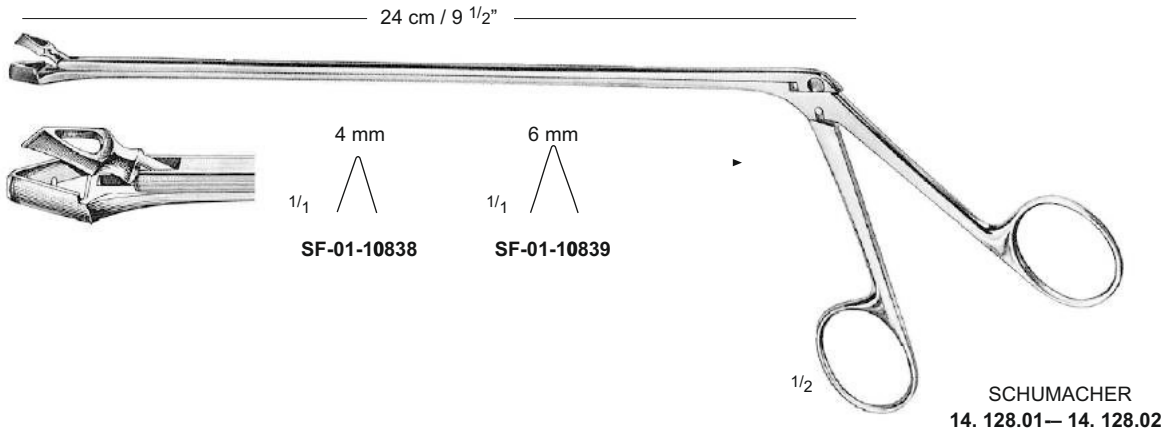

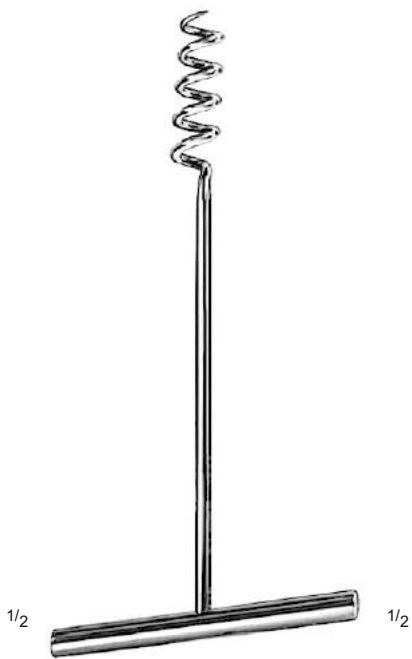

DOYEN
SF-01-10842
17 cm / 6 3/4"
ø 20 mm

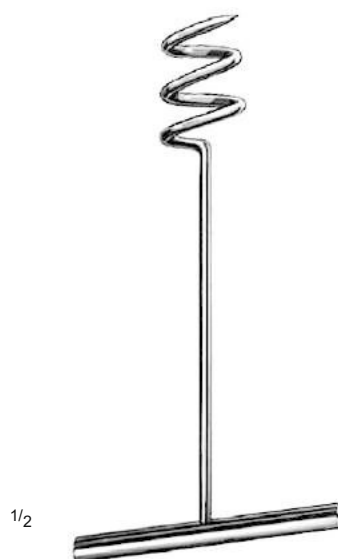

DOYEN
SF-01-10843
14 cm / 5 1/2"
ø 29 mm



NOVAK
SF-01-10844
23 cm / 9"

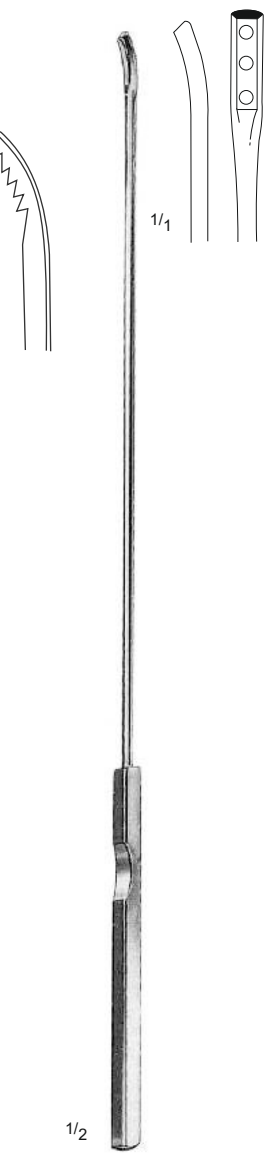

KOVOURKIAN-YOUNG
SF-01-10845
30 cm / 12"



SF-01-10846
1 - 7 mm



SF-01-10852
#1 - 7 mm



SF-01-10847
2 - 8 mm



SF-01-10853
2 - 8 mm



SF-01-10848
3 - 10 mm



SF-01-10854
3 - 10 mm

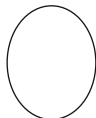

SF-01-10849
4 - 11 mm



SF-01-10855
4 - 11 mm

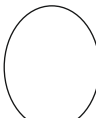

SF-01-10850
5 - 12 mm



SF-01-10856
5 - 12 mm

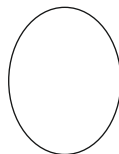

$\frac{1}{1}$
SF-01-10851
6 - 15 mm



$\frac{1}{1}$
SF-01-10857
6 - 15 mm



$\frac{1}{2}$

SIMON
29 cm / 11 $\frac{1}{2}$ "
Rigid, Sharp



$\frac{1}{2}$

SCHROEDER
30 cm / 12"
Rigid, Sharp

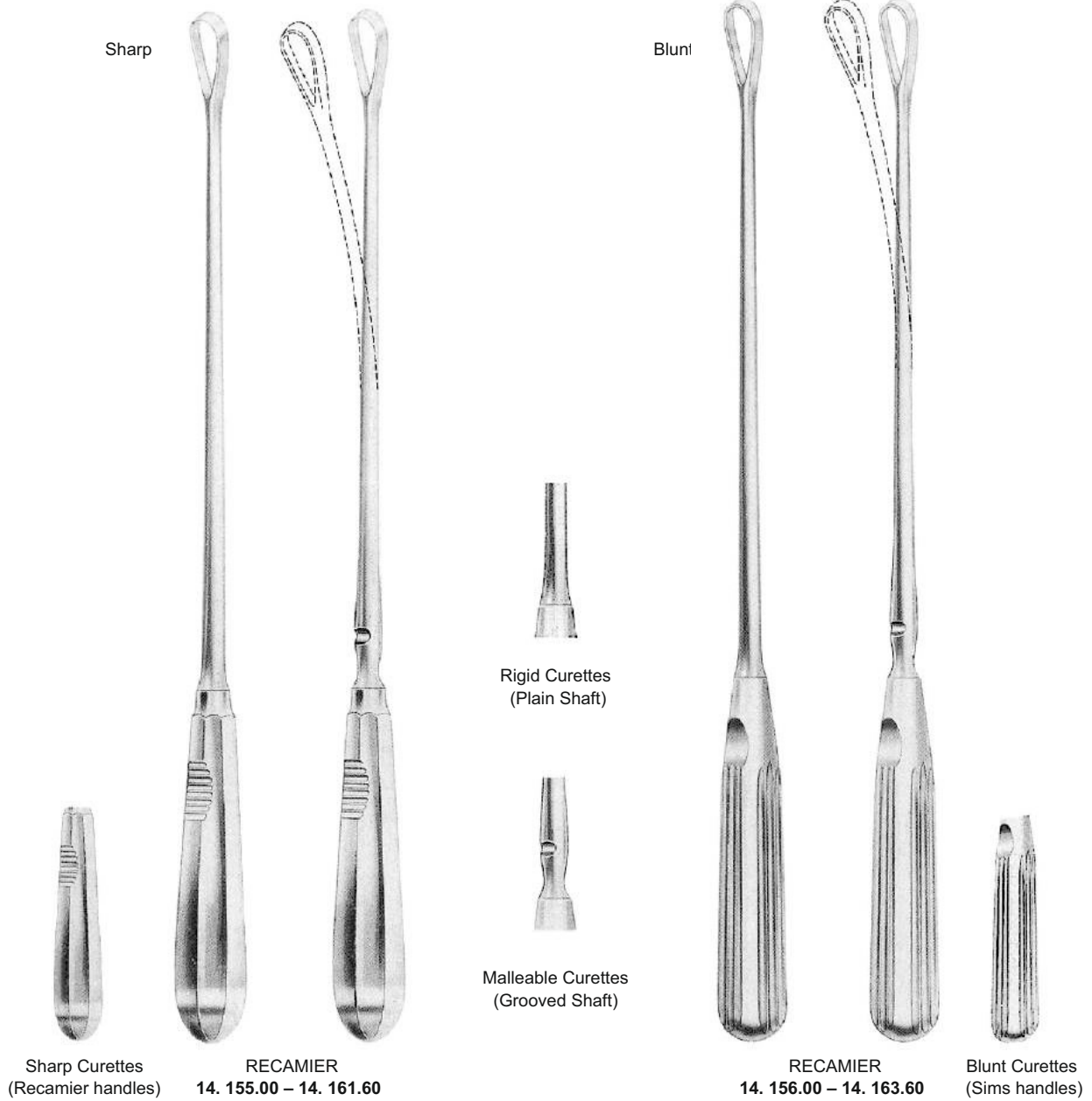

Rigid	Malleable
SF-01-10858 – Fig 00- 5 mm –	–
SF-01-10859 – Fig 0- 6 mm –	SF-01-10876
SF-01-10860 – Fig 1- 7 mm –	SF-01-10877
SF-01-10861 – Fig 2- 8 mm –	SF-01-10878
SF-01-10862 – Fig 3- 9 mm –	SF-01-10879
SF-01-10863 – Fig 4- 11 mm –	SF-01-10880
SF-01-10864 – Fig 5- 12 mm –	SF-01-10881
SF-01-10865 – Fig 6- 14 mm –	SF-01-10882
SF-01-10866 – Fig 7- 15 mm –	SF-01-10883
SF-01-10867 – Fig 8- 16 mm –	SF-01-10884
SF-01-10868 – Fig 9- 19 mm –	SF-01-10885
SF-01-10869 – Fig 14. 20 mm –	SF-01-10886
SF-01-10870 – Fig 15. 21 mm –	SF-01-10887
SF-01-10871 – Fig 21. 23 mm –	SF-01-10888
SF-01-10872 – Fig 13-25 mm –	SF-01-10889
SF-01-10873 – Fig 14-30 mm –	SF-01-10890
SF-01-10874 – Fig 15-35 mm –	SF-01-10891
SF-01-10875 – Fig 16-40 mm –	SF-01-10892

Rigid	Malleable
SF-01-10893 – Fig 00- 5 mm –	–
SF-01-10894 – Fig 0- 6 mm –	SF-01-10911
SF-01-10895 – Fig 1- 7 mm –	SF-01-10912
SF-01-10896 – Fig 2- 8 mm –	SF-01-10913
SF-01-10897 – Fig 3- 9 mm –	SF-01-10914
SF-01-10898 – Fig 4- 11 mm –	SF-01-10915
SF-01-10899 – Fig 5- 12 mm –	SF-01-10916
SF-01-10900 – Fig 6- 14 mm –	SF-01-10917
SF-01-10901 – Fig 7- 15 mm –	SF-01-10918
SF-01-10902 – Fig 8- 16 mm –	SF-01-10919
SF-01-10903 – Fig 9- 19 mm –	SF-01-10920
SF-01-10904 – Fig 14. 20 mm –	SF-01-10921
SF-01-10905 – Fig 15. 21 mm –	SF-01-10922
SF-01-10906 – Fig 21. 23 mm –	SF-01-10923
SF-01-10907 – Fig 13-25 mm –	SF-01-10924
SF-01-10908 – Fig 14-30 mm –	SF-01-10925
SF-01-10909 – Fig 15-35 mm –	SF-01-10926
SF-01-10910 – Fig 16-40 mm –	SF-01-10927

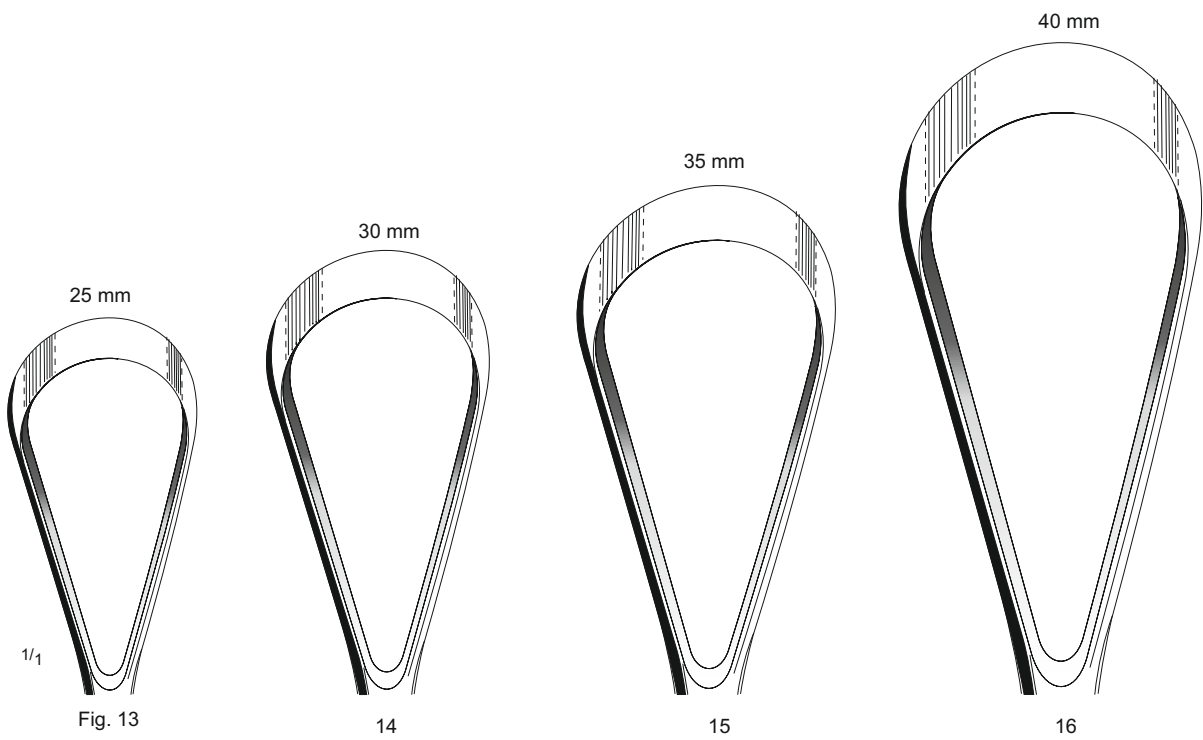
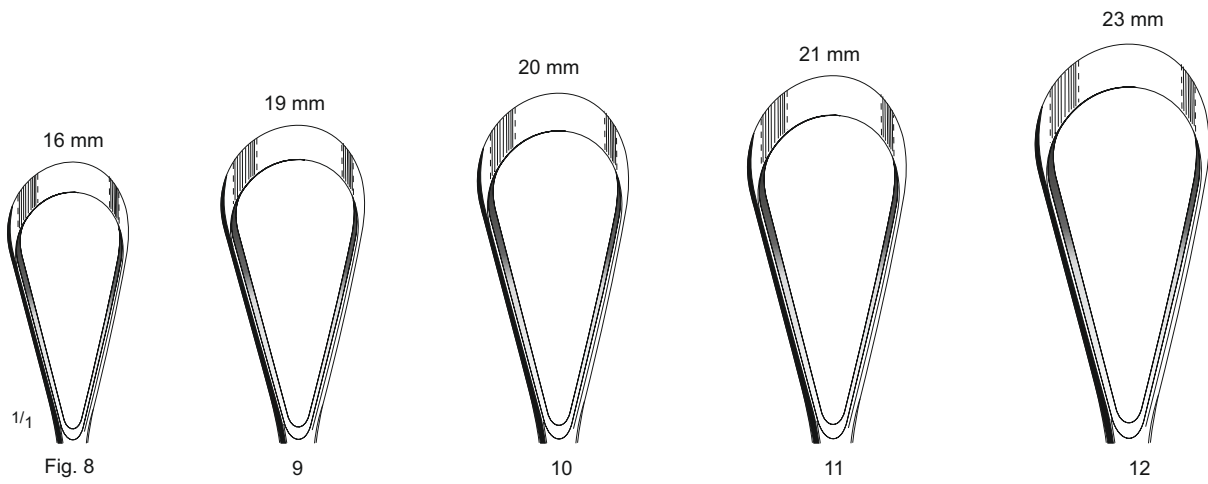
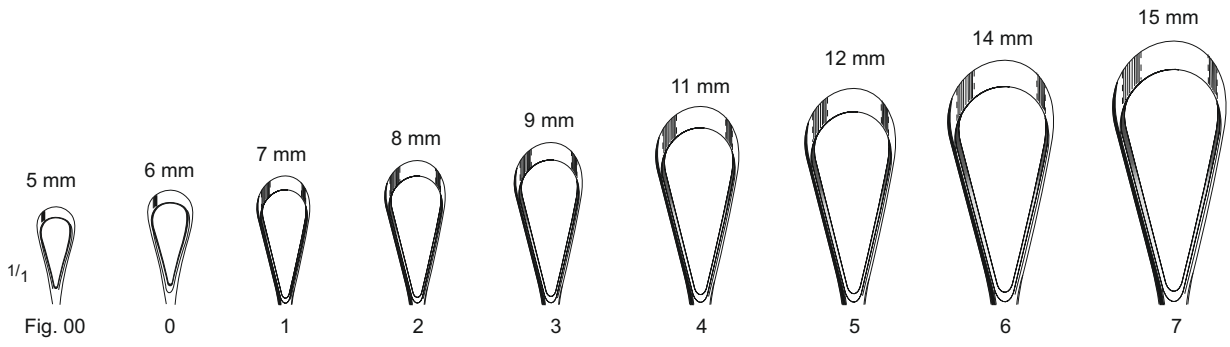

RECAMIER - SIMS



1/4

MARTIN
10-101-340
34 cm / 13 1/2"
cm scale



1/3

BEACHAM
10-102-240
24 cm / 9 1/2"

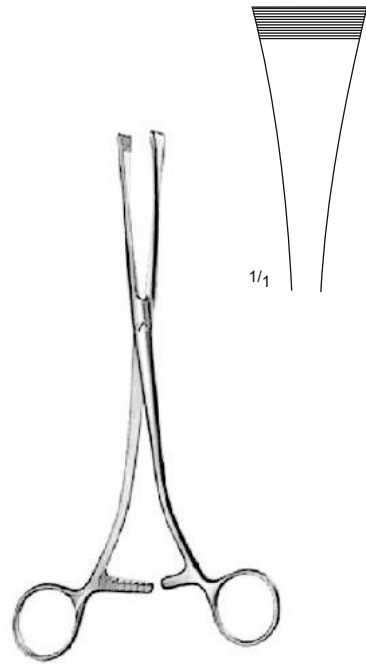

1/1

1/3

GREEN ARMYTAGE
10-103-220
22 cm / 8 3/4"



1/4

DeLEE
10-104-360
36 cm / 14 1/4"

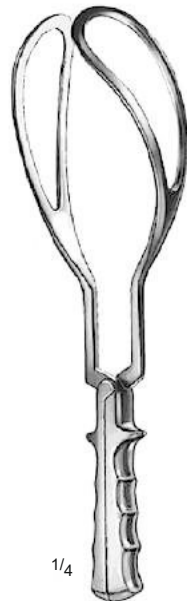

1/4

SIMPSON
10-105-320 – 32 cm / 12 1/2"
10-106-360 – 36 cm / 14 1/4"



1/4

KIELLAND
10-107-400
40 cm / 15 3/4"

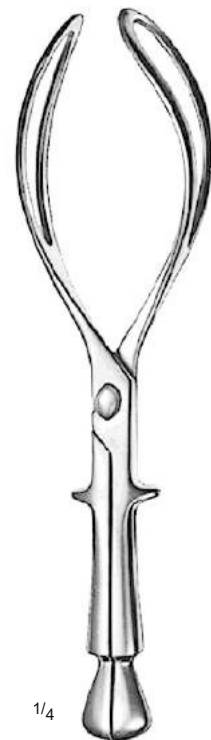

1/4

NAEGELE
10-108-360 – 36 cm / 14"
10-109-400 – 40 cm / 15 3/4"

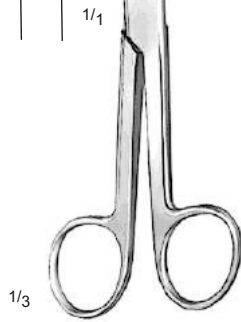
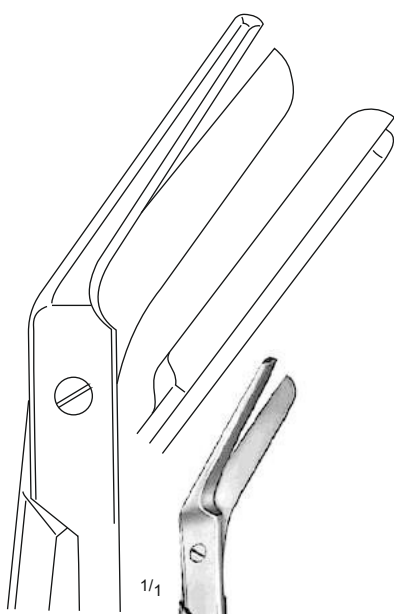

1/3

BRAUN STADLER
SF-01-10937
15 cm / 6"

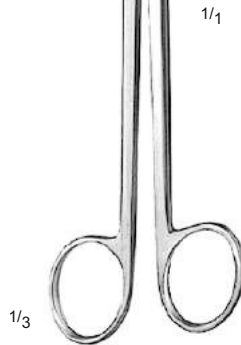

1/3

BRAUN STADLER
SF-01-10938
21 cm / 8 1/4"

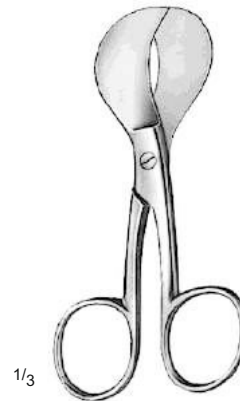
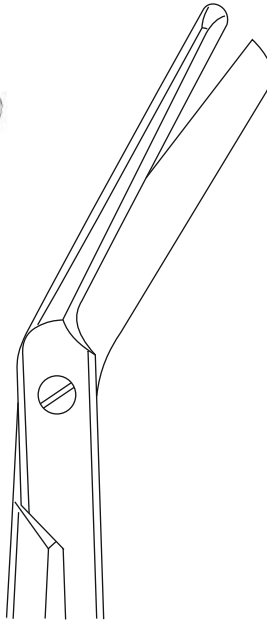

1/3

USA PATTERN
SF-01-10939
10.5 cm / 4 1/4"

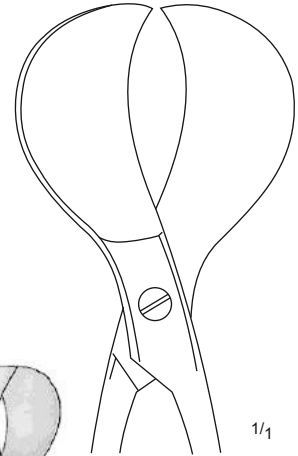

1/1

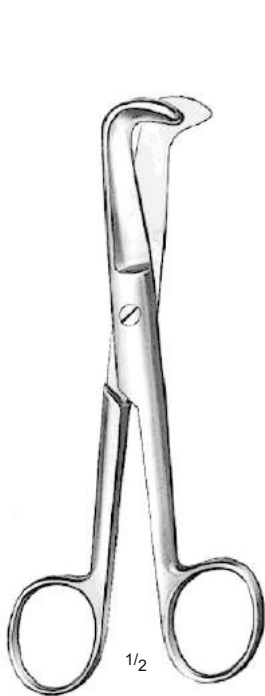

1/2

SCHUMACHER
SF-01-10940
16 cm / 6 1/4"

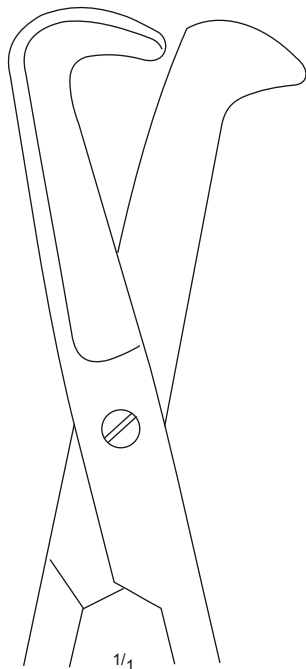

1/1

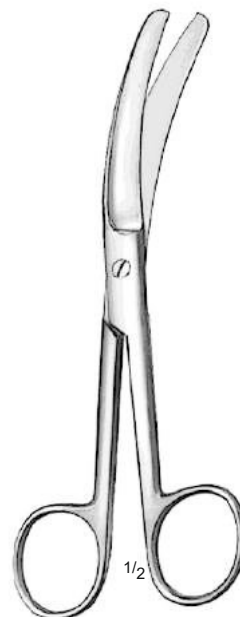

1/2

BUSCH
SF-01-10941
16 cm / 6 1/4"

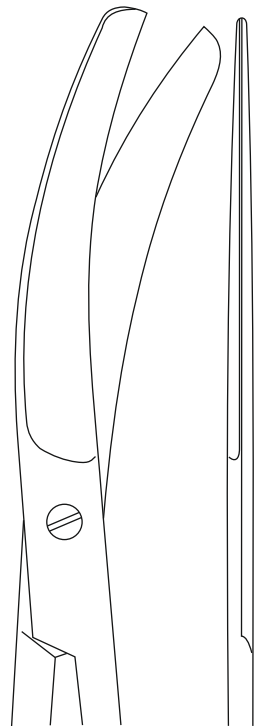

1/1



1/4

SELHEIM
SF-01-10942
28 cm / 11"

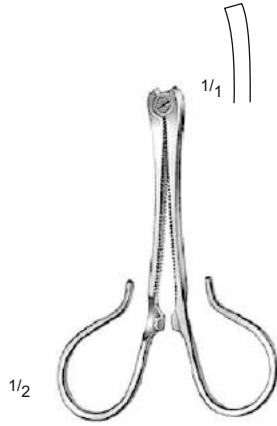

1/2

KANE
SF-01-10943
8.5 cm / 3 1/2"



1/2

COLLIN
SF-01-10944
9 cm / 3 1/2"

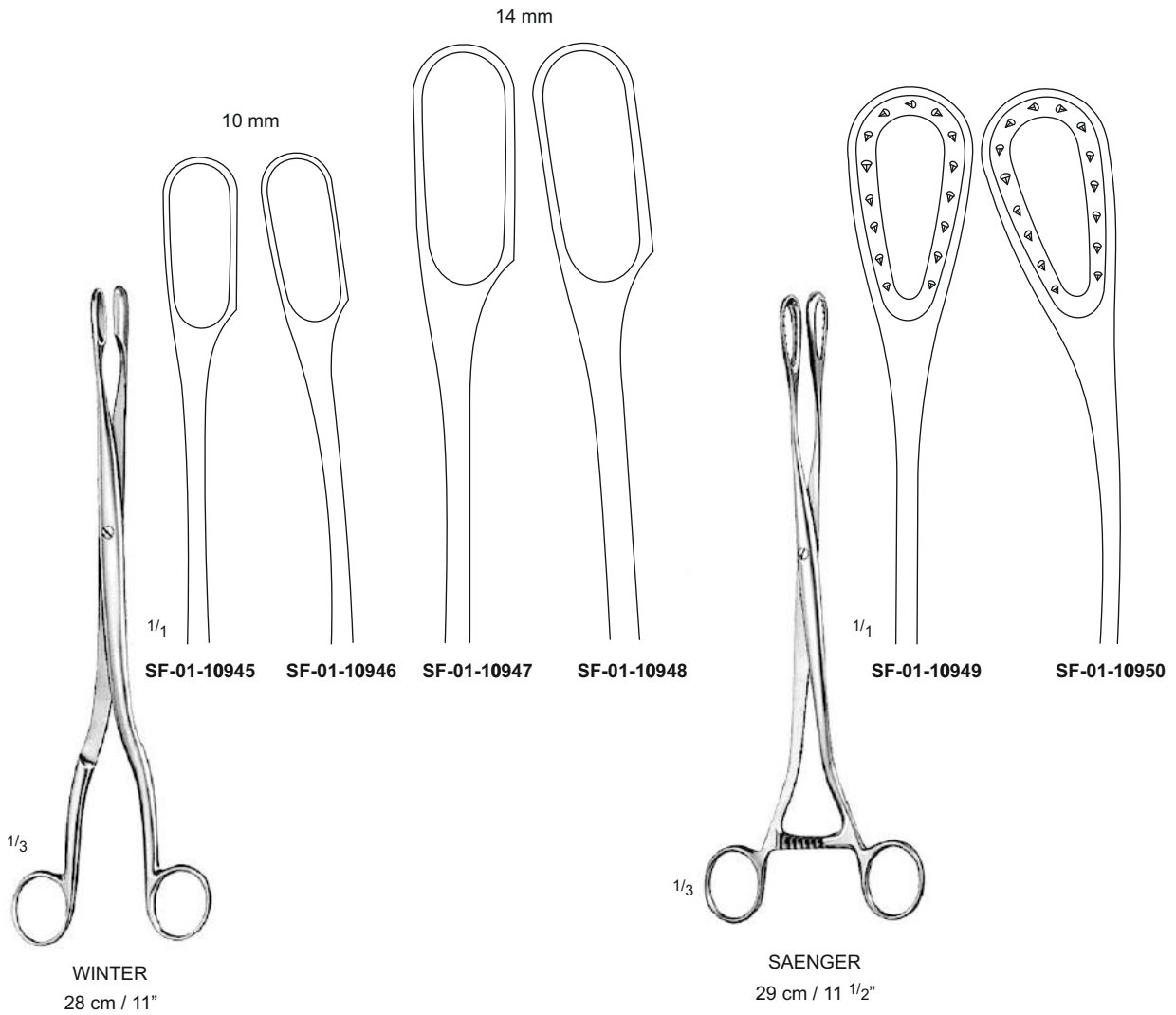

ORTHOPEDIC



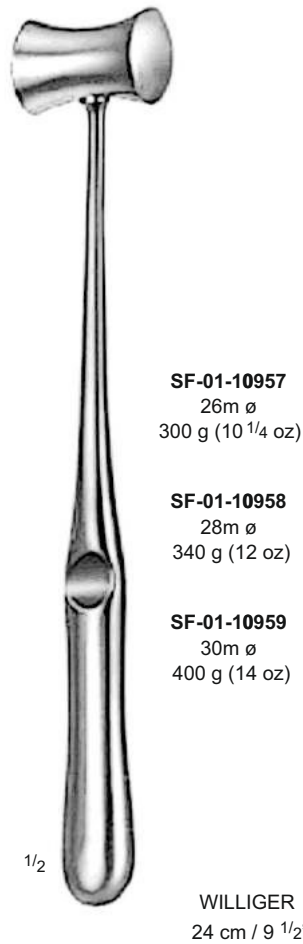
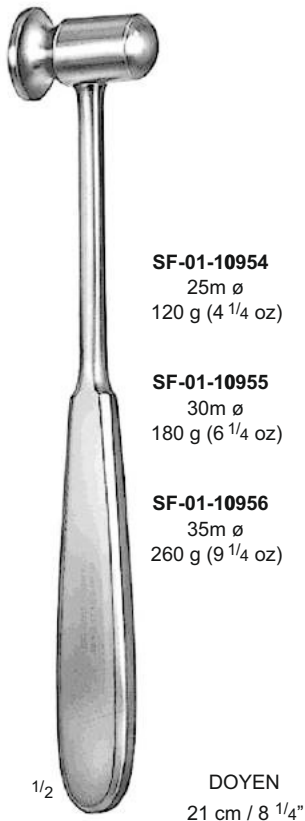
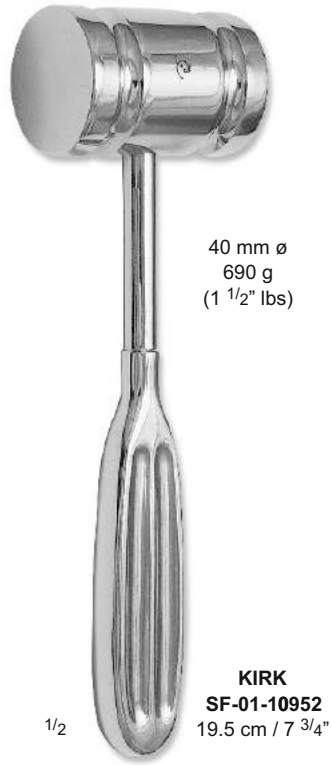
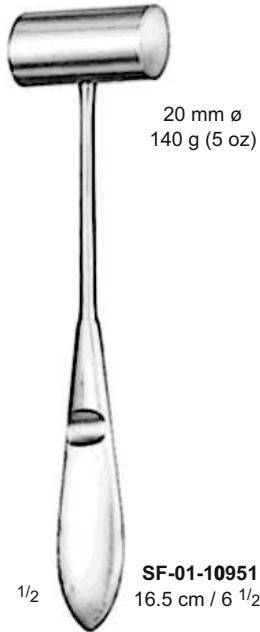



26 mm ø
320 gm (11 1/2 oz)

with Interchangeable
Fibre Facings

1/2

MEAD
SF-01-10961
18 cm / 7"



30 mm ø
400 gm (14 oz)

1/2

GERZOG
SF-01-10962
18 cm / 7"

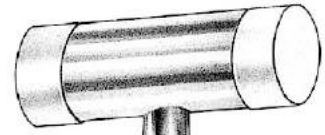

25 mm ø
200 gm (7 oz)

1/2

SF-01-10963
18 cm / 7"



SF-01-10964
19 mm ø
215 gm (7 oz)
19 cm / 7 1/2"

SF-01-10965
25 mm ø
335 gm (11 1/2 ozs)
23 cm - 9"



SF-01-10966
19 mm ø
230 gm (8 oz)

SF-01-10967
25 mm ø
260 gm (9 oz)

1/2

LUCAE
19 cm 7 1/2"



30 mm ø
510 gm
(18 oz)

1/3

SF-01-10968
26 cm 10 1/2"

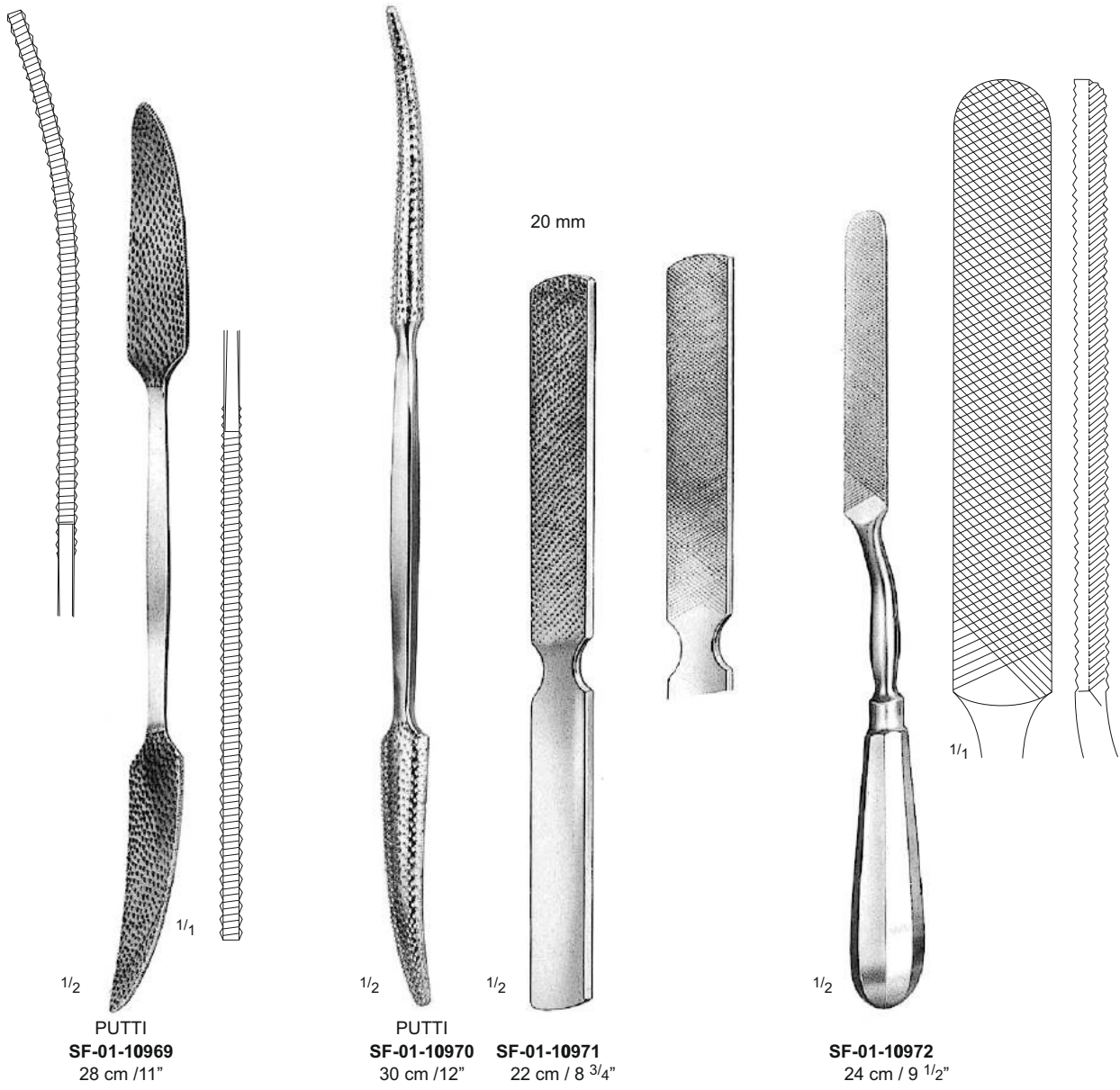

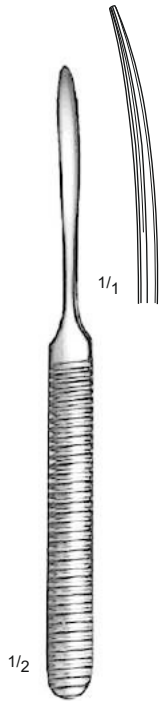

WILLIGER
SF-01-10973
17 cm / 6 3/4"

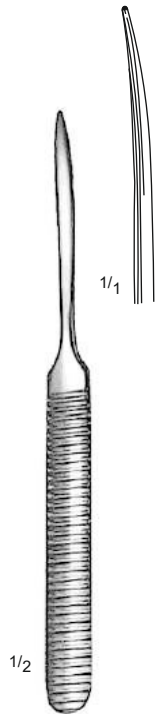

WILLIGER
SF-01-10974
16 cm / 6 1/4"

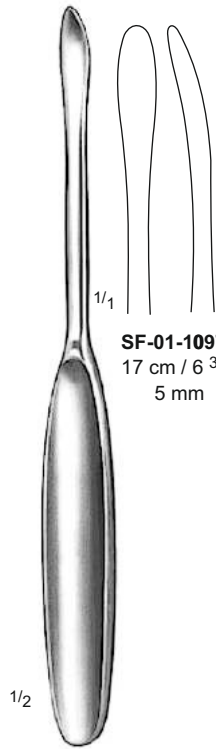

SF-01-10975
17 cm / 6 3/4"
5 mm



SF-01-10976
17 cm / 6 3/4"
7 mm

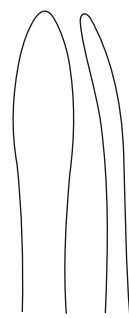

SF-01-10977
20 cm / 8"
8 mm

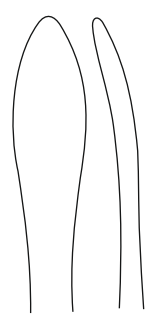

SF-01-10978
20 cm / 8"
10 mm

LANGENBECK

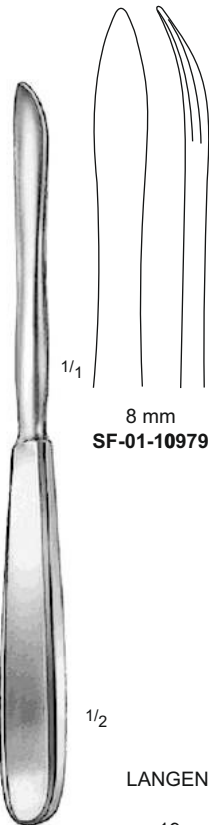

8 mm
SF-01-10979

1/2

LANGENBECK

19 cm / 7 1/2"

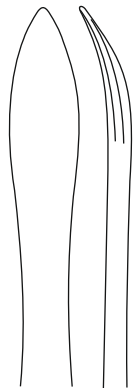

10 mm
SF-01-10980



SF-01-10981
16 cm / 6 1/4"
7 mm

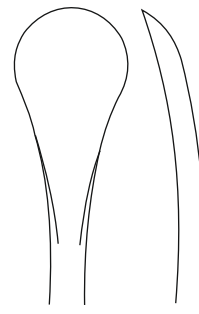

SF-01-10982
19 cm / 7 1/2"
15 mm

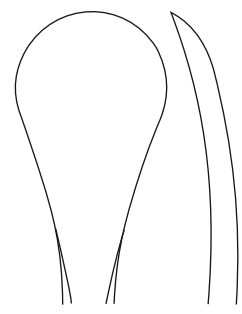

SF-01-10983
19 cm / 7 1/2"
20 mm

1/2

HOEN



WILLIGER
SF-01-10984
13 cm / 5"

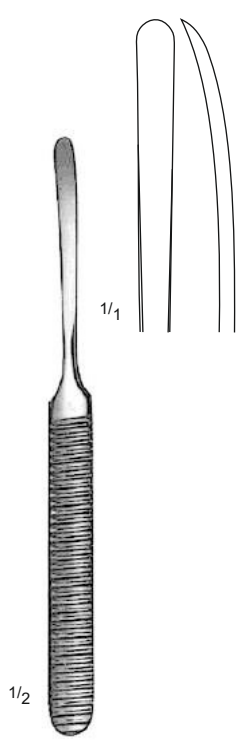

WILLIGER
SF-01-10985
16 cm / 6 1/4"

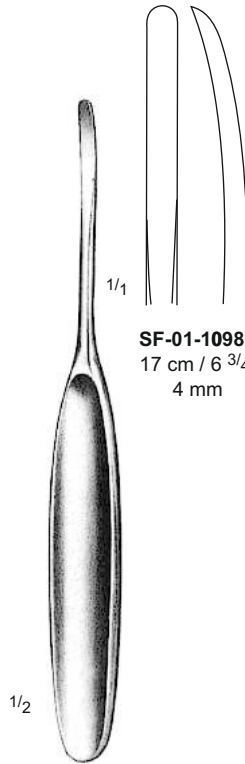

CUSHING

SF-01-10986
17 cm / 6 3/4"
4 mm

SF-01-10987
17 cm / 6 3/4"
6 mm

SF-01-10988
19.5 cm / 7 3/4"
5 mm

SF-01-10989
19.5 cm / 7 3/4"
7 mm



McDONALD
SF-01-10990
19 cm / 7 1/2"



ALDERDYCE
SF-01-10991
21 cm / 8 1/4"



ADSON
17 cm / 6 3/4"

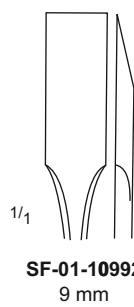

SF-01-10992
9 mm

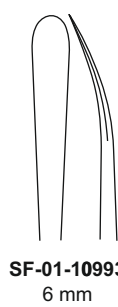

SF-01-10993
6 mm

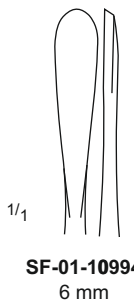

SF-01-10994
6 mm



SF-01-10995
6 mm

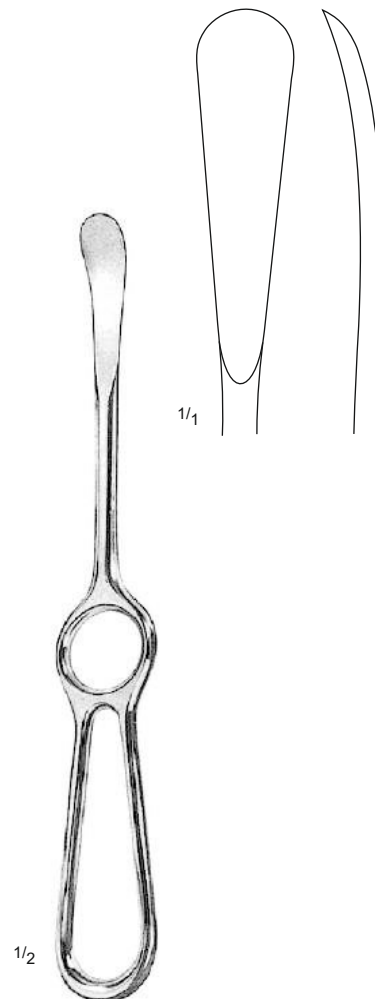

SEDILOT
SF-01-10996
21 cm / 8 1/4"

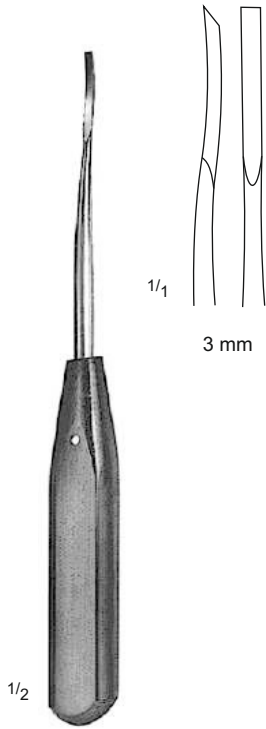

SF-01-10997
18.5 cm / 7 1/4"

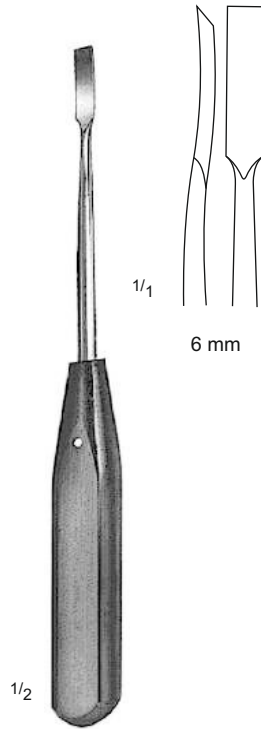

SF-01-10998
18.5 cm / 7 1/2"

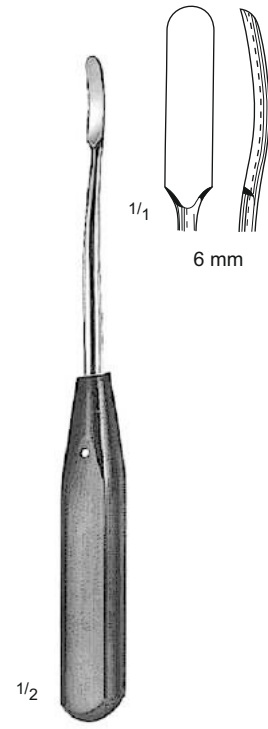

SF-01-10999
18.5 cm / 7 1/2"

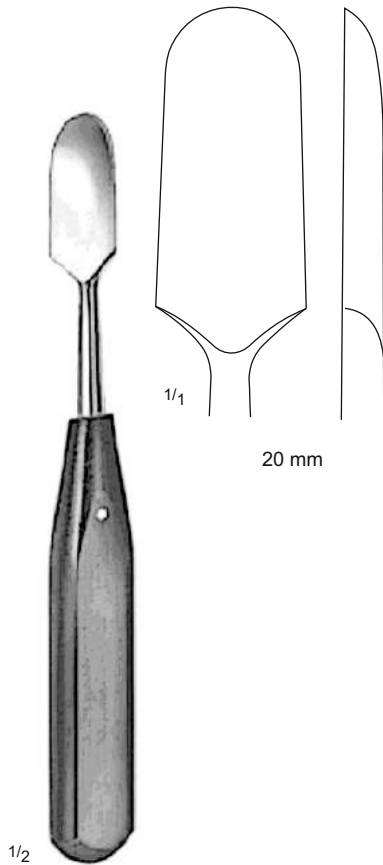

SF-01-11000
20 cm / 8"

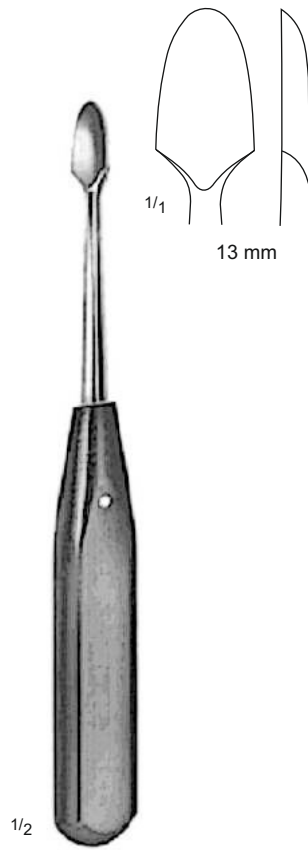

SF-01-11001
20 cm / 8"

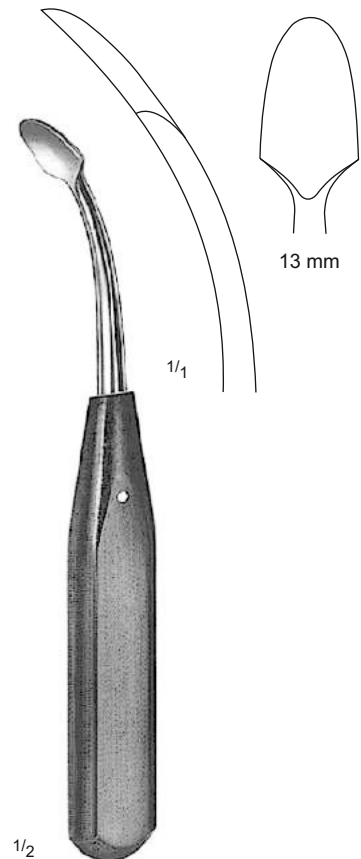

SF-01-11002
20 cm / 8"

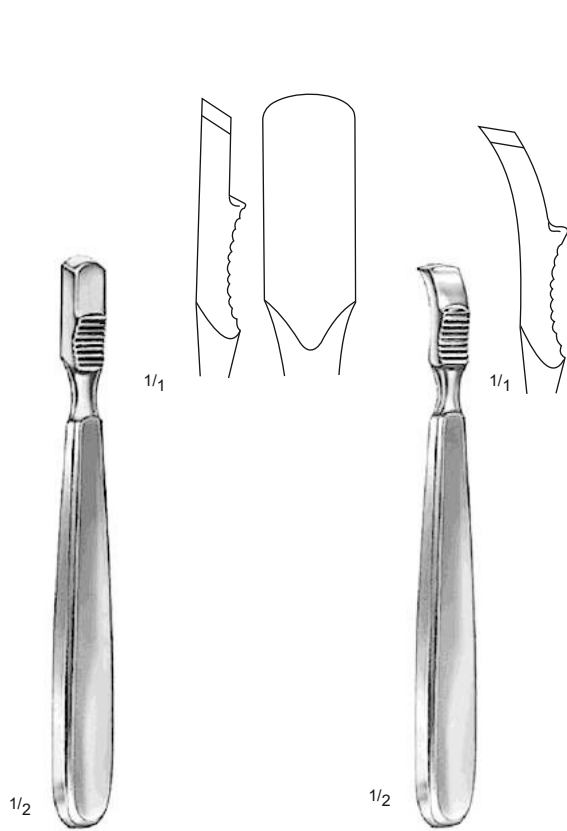

FARABEUF
SF-01-11003
15 cm / 6"

FARABEUF
SF-01-11004
15 cm / 6"

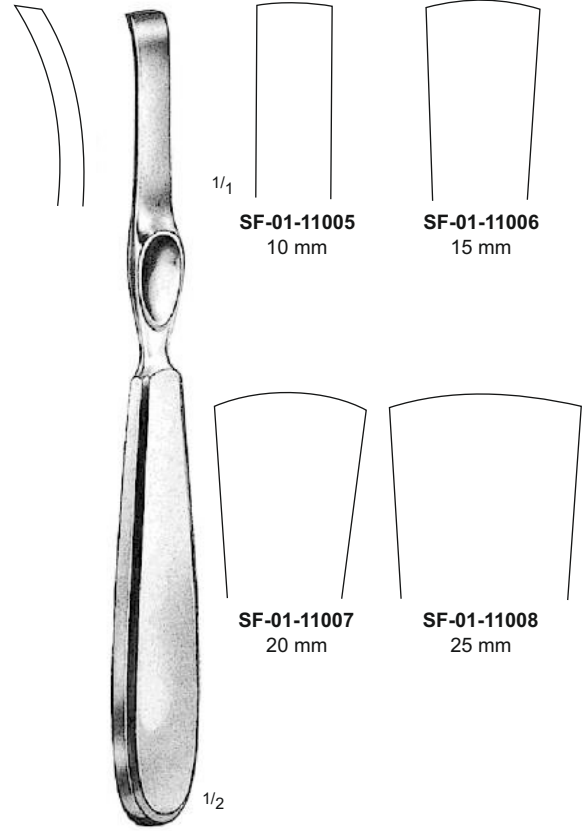

LAMBOTTE
21 cm / 8 1/4"

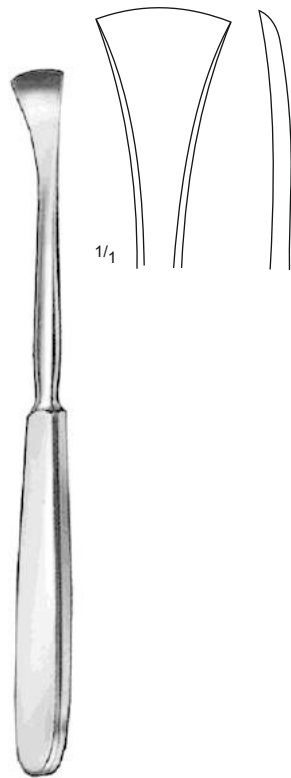

LANGENBECK
SF-01-11009
19 cm / 7 1/2"

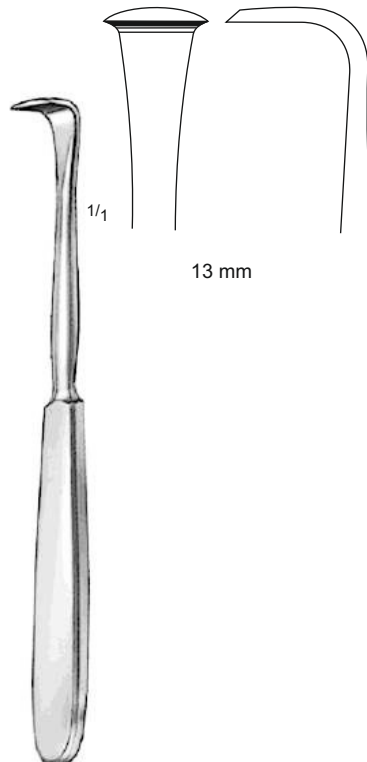

LANGENBECK
SF-01-11010
18 cm / 7"

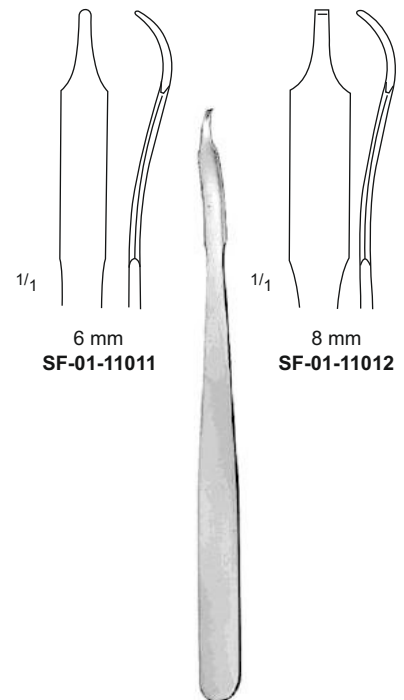

MINI-HOHMANN
16 cm / 6 1/4"



HOHMANN

SF-01-11013
22 cm / 8 3/4"

SF-01-11014
24 cm / 9 1/2"

SF-01-11015
24 cm / 9 1/2"

SF-01-11016
29 cm / 11 1/2"

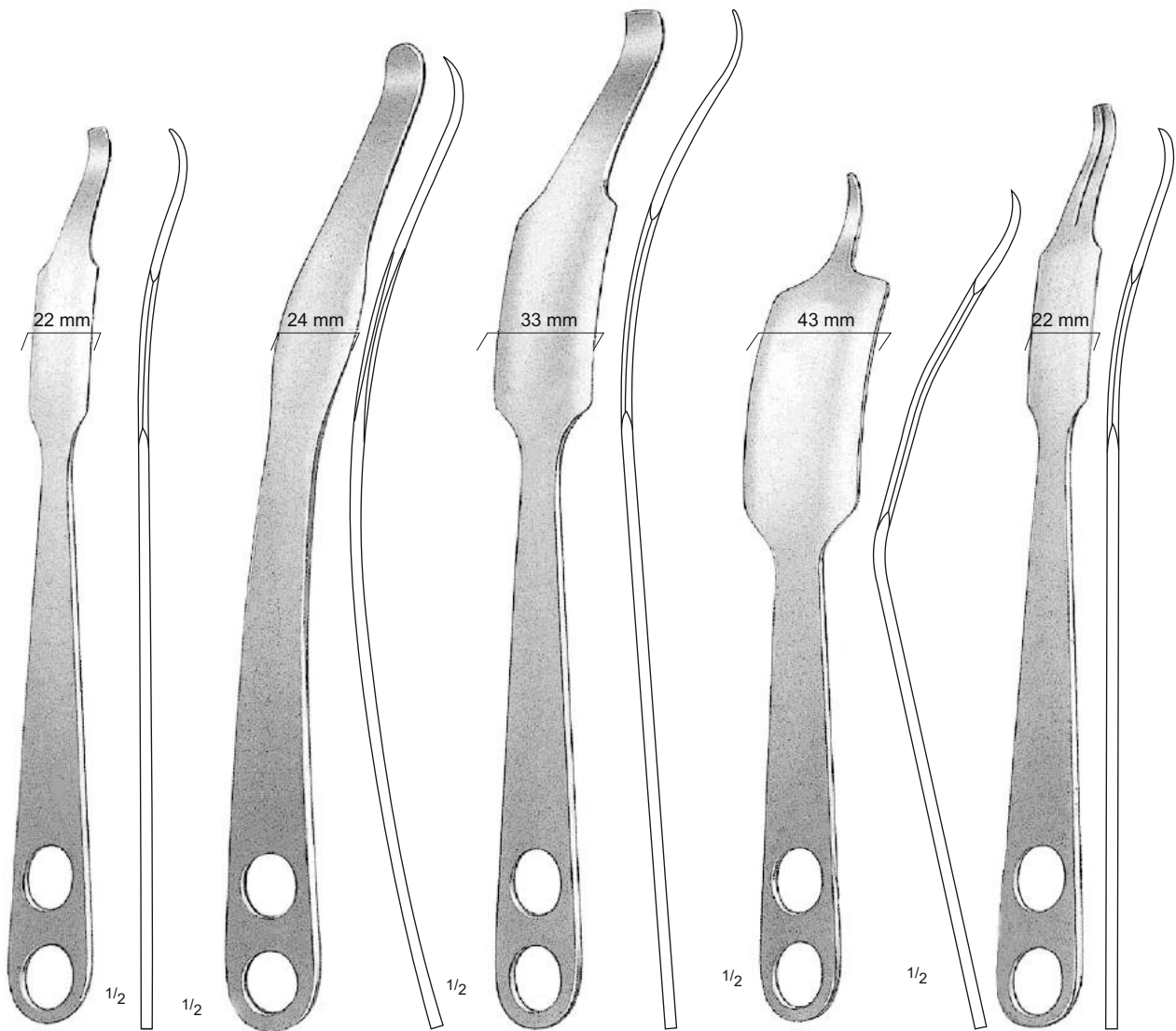

HOHMANN

LANGE-HOHMANN

SF-01-11017
25 cm / 10"

SF-01-11018
28 cm / 11"

SF-01-11019
29 cm / 11 1/2"

SF-01-11020
24 cm / 9 1/2"

SF-01-11021
26 cm / 10 1/4"



SF-01-11022
23 cm / 9"



CLEVELAND SF-01-11023
15 cm / 6"

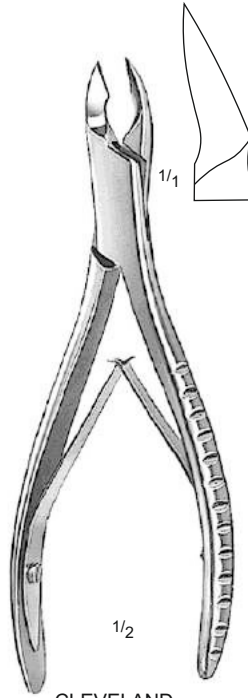

CLEVELAND SF-01-11024
17 cm / 6 3/4"



COTTLE-KAZANJIAN SF-01-11025
18 cm / 7"



SF-01-11026
14 cm / 5 1/2"



SF-01-11027
17 cm / 6 3/4"



SF-01-11028
14 cm / 5 1/2"

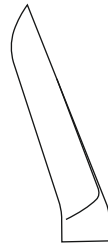

SF-01-11029
17 cm / 6 3/4"

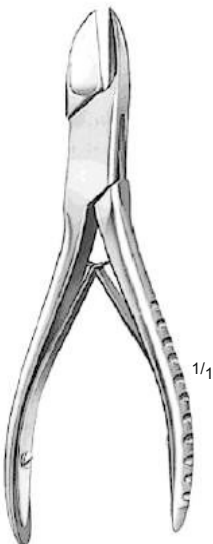

SF-01-11030
19 cm / 7 1/2"

LISTON



SF-01-11031
22 cm / 8 3/4"



SF-01-11032
19 cm / 7 1/2"

LISTON

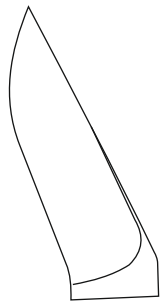
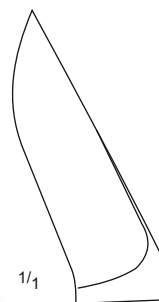

SF-01-11033
22 cm / 8 3/4"

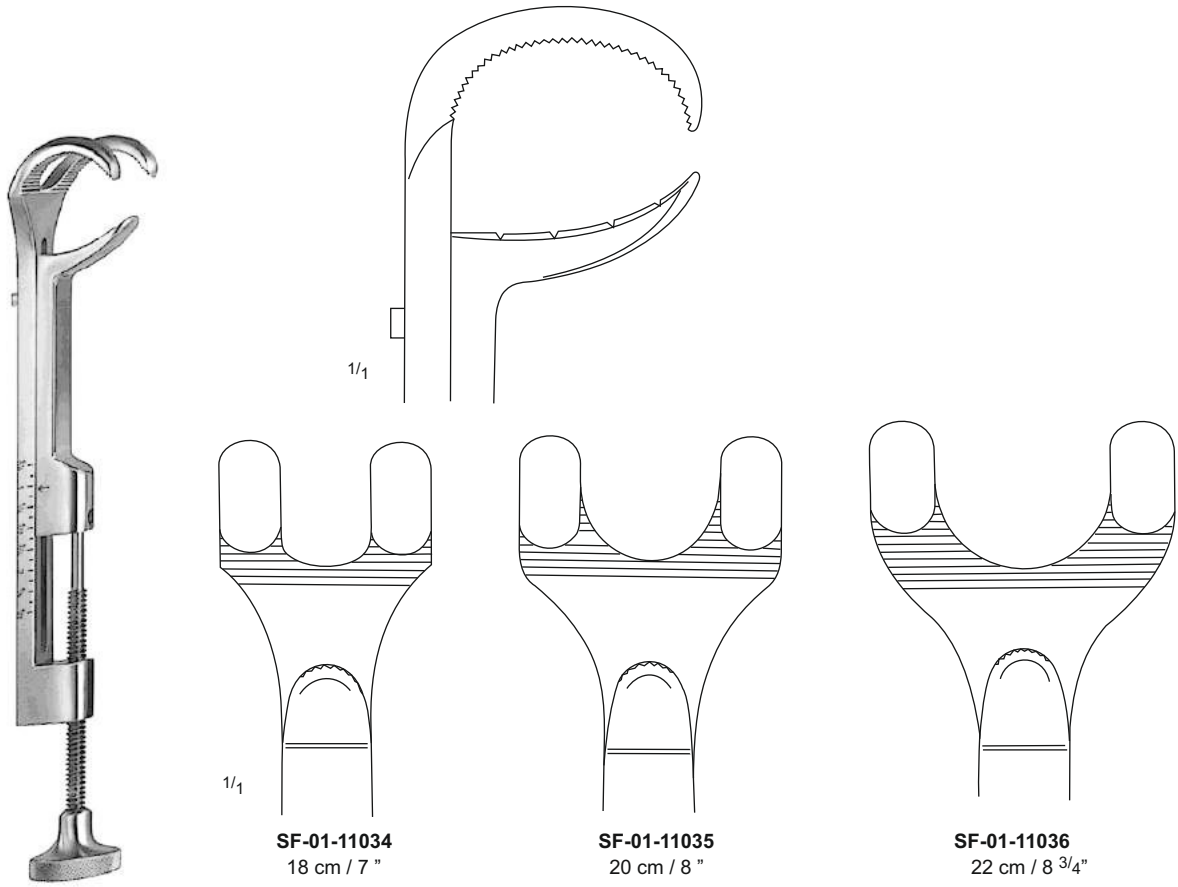

GERSTER-LOWMAN

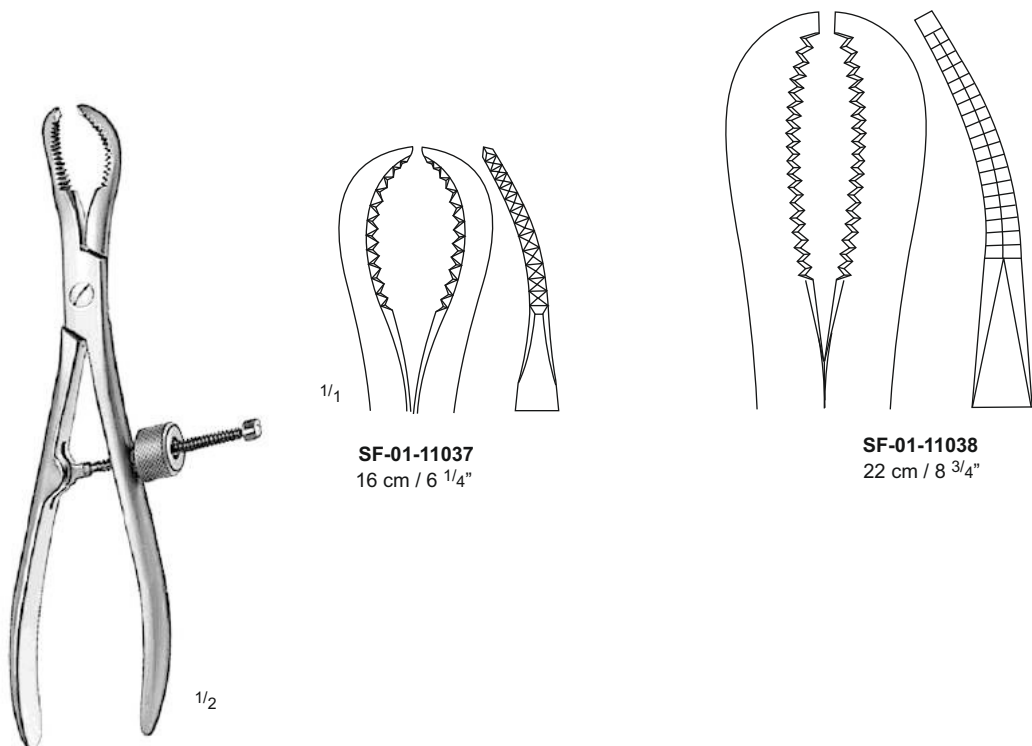

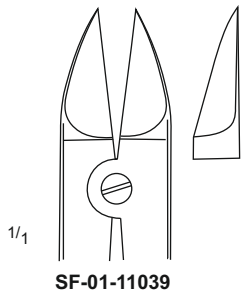

SF-01-11039

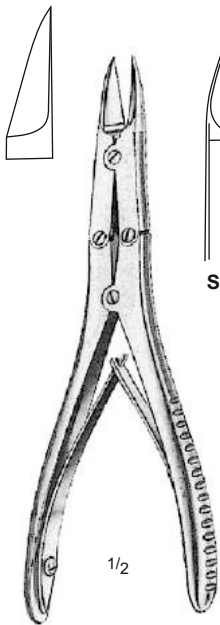

SF-01-11040

LISTON MINI
15 cm / 6"

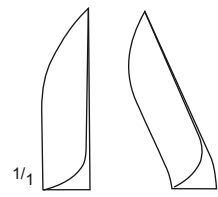
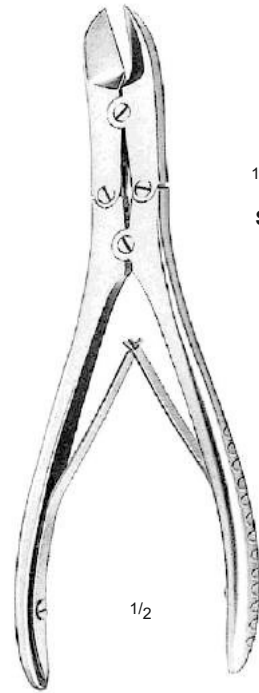

SF-01-11041 SF-01-11042

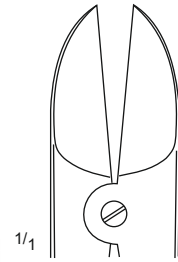

RUSKIN LISTON
18 cm / 7"

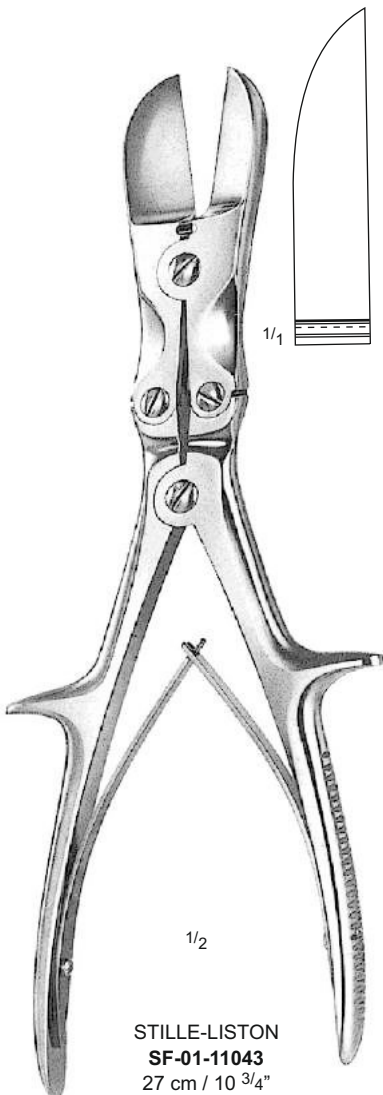

STILLE-LISTON
SF-01-11043
27 cm / 10 3/4"

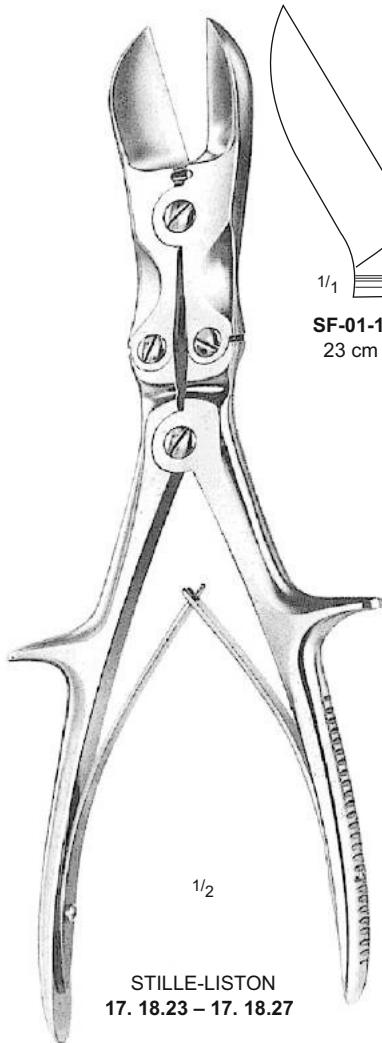

STILLE-LISTON
17. 18.23 - 17. 18.27

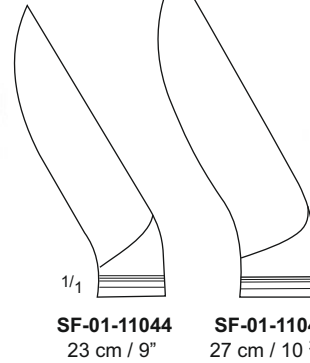

SF-01-11044
23 cm / 9"

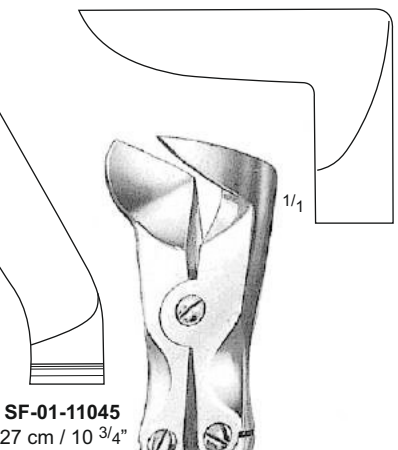

SF-01-11045
27 cm / 10 3/4"

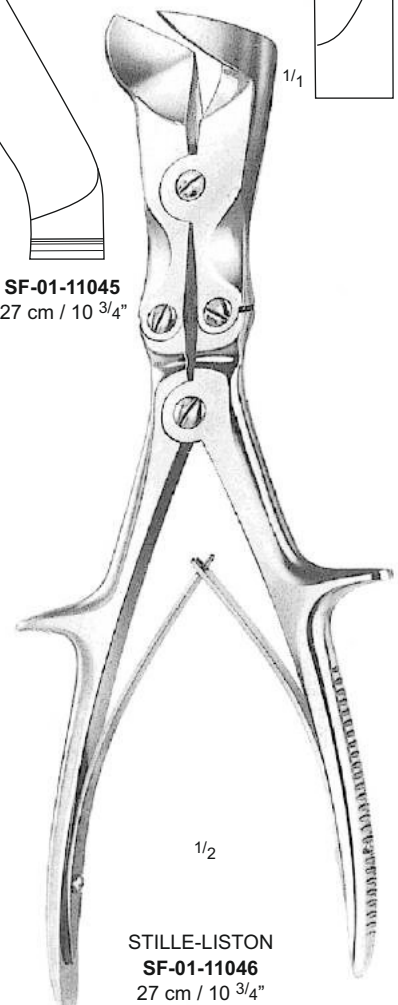

STILLE-LISTON
SF-01-11046
27 cm / 10 3/4"

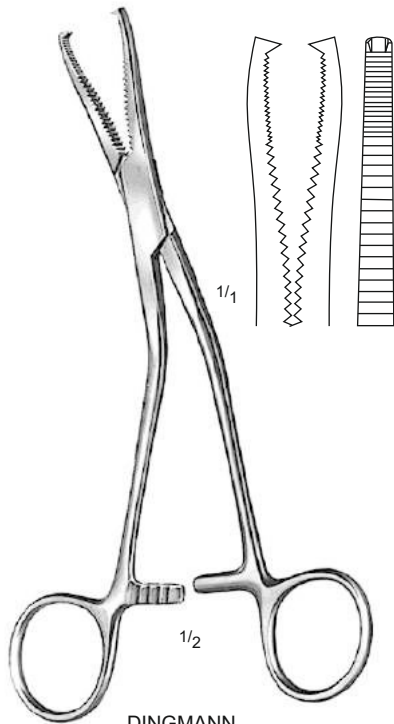

DINGMANN
SF-01-11047
19 cm / 7 1/2"

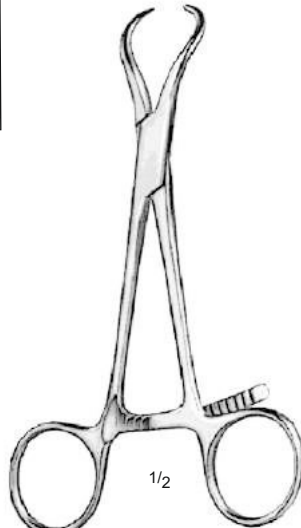

SF-01-11048
14 cm / 5 1/2"

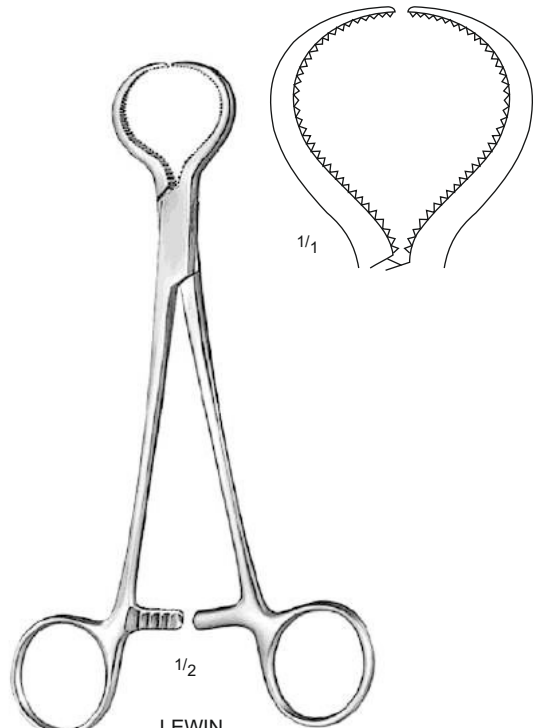

LEWIN
SF-01-11049
18 cm / 7"

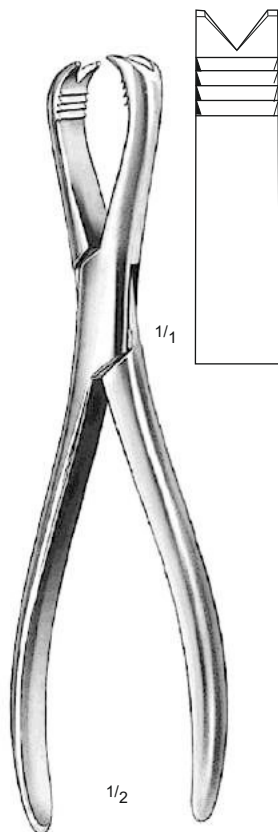

LANGENBECK
SF-01-11050
21 cm / 8 1/4"

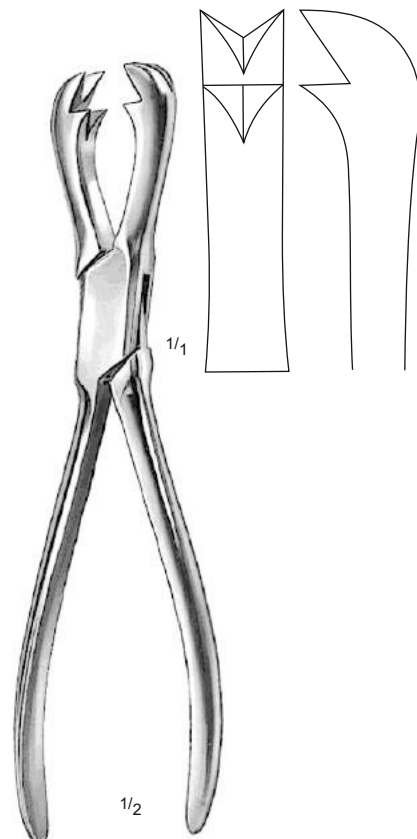

FERGUSON
SF-01-11051
21 cm / 8 1/4"

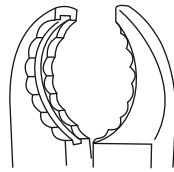
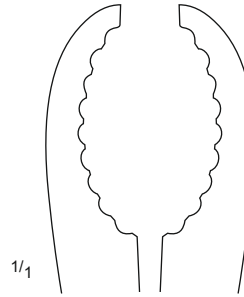
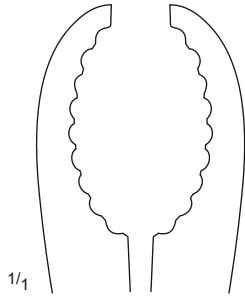

SF-01-11052
SF-01-11053
23 cm / 9"

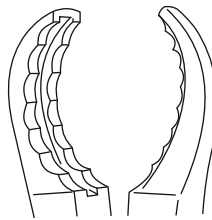

SF-01-11054
SF-01-11055
25 cm / 10"

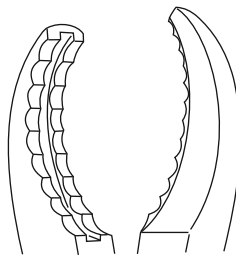

SF-01-11056
SF-01-11057
28 cm / 11"

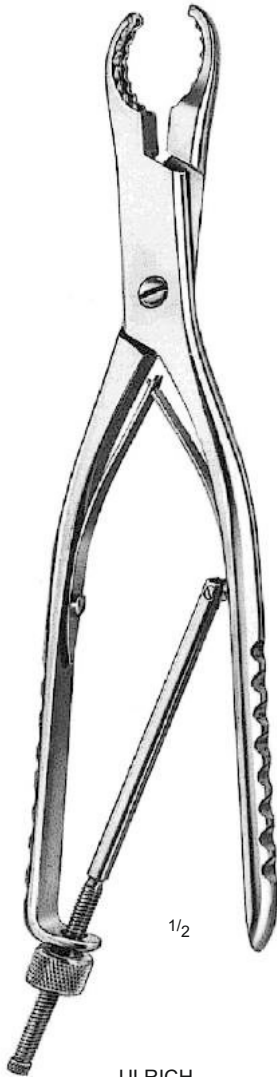
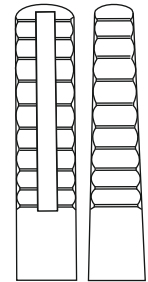

ULRICH
SF-01-11058 - SF-01-11059

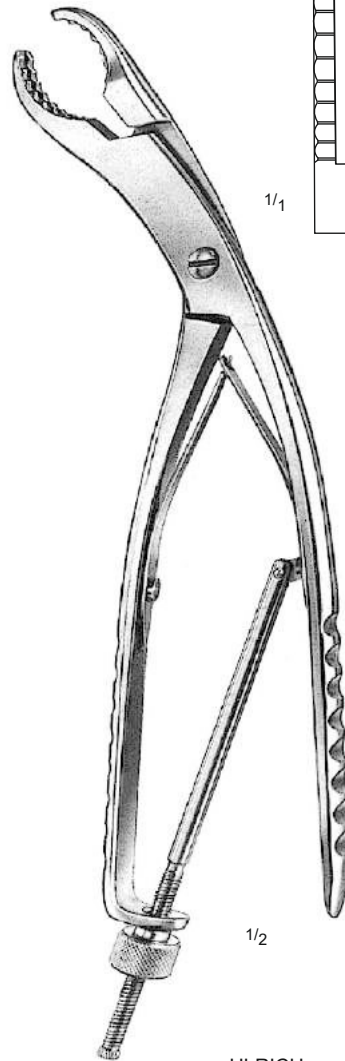

ULRICH
SF-01-11060 - SF-01-11061

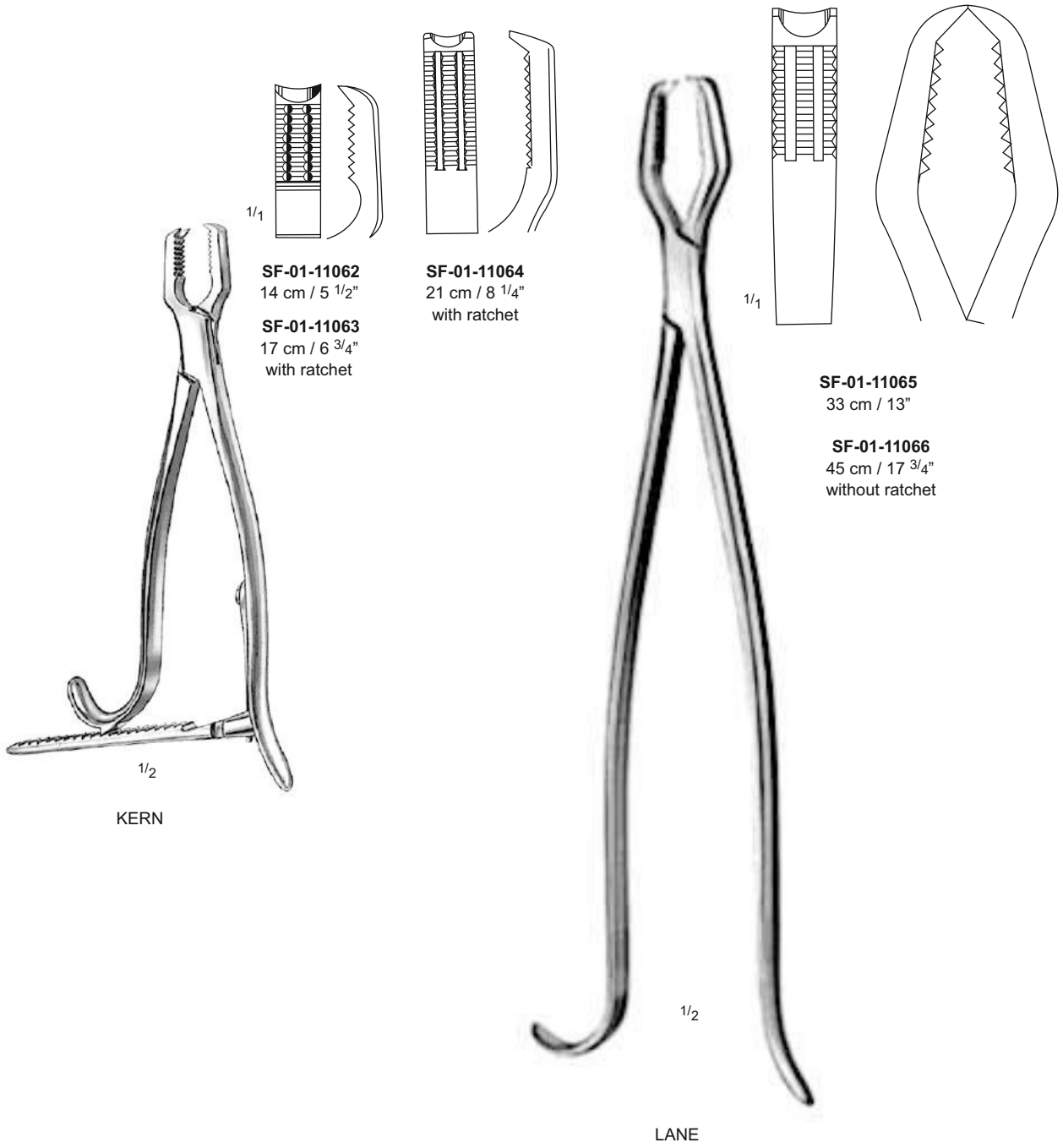

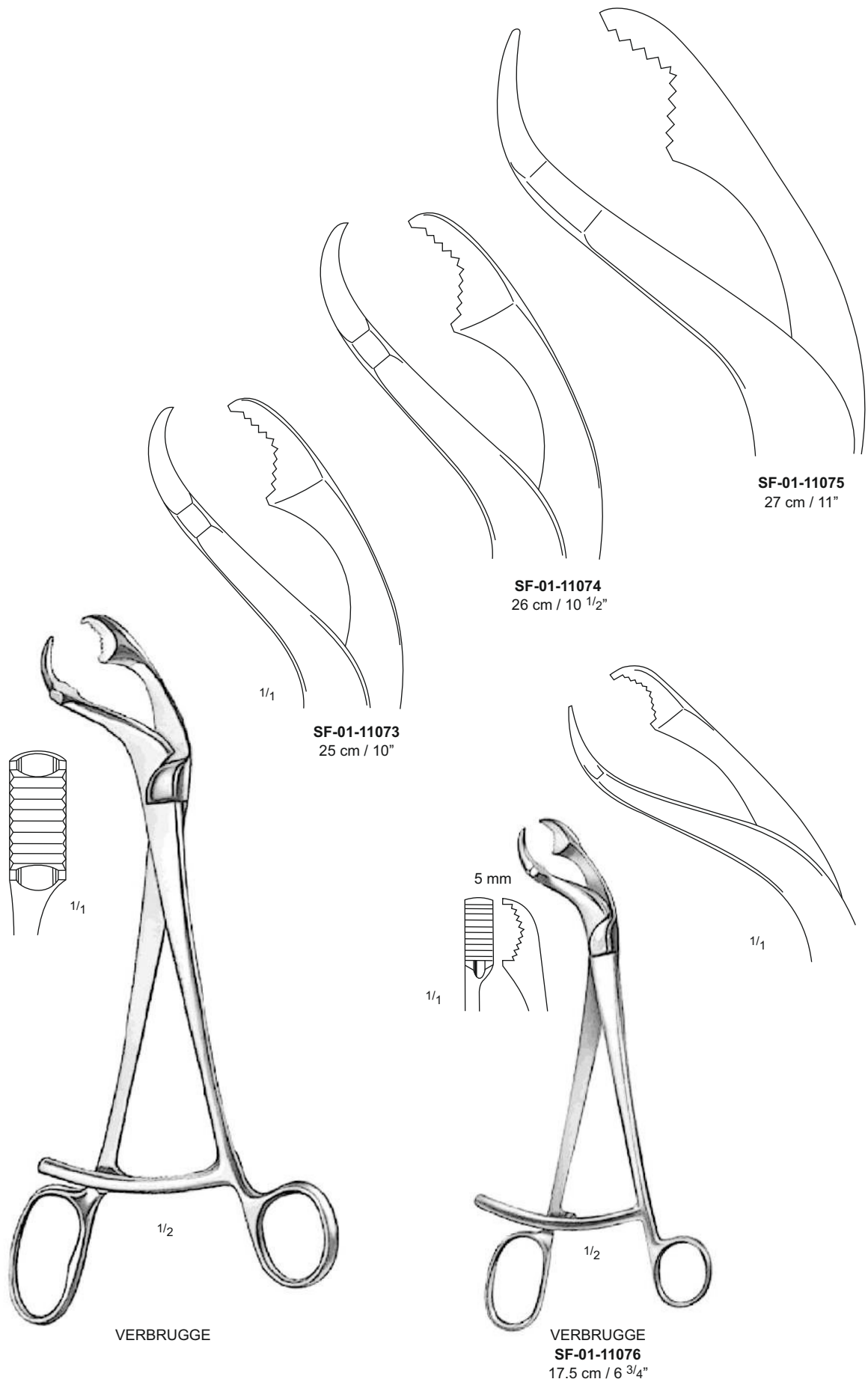

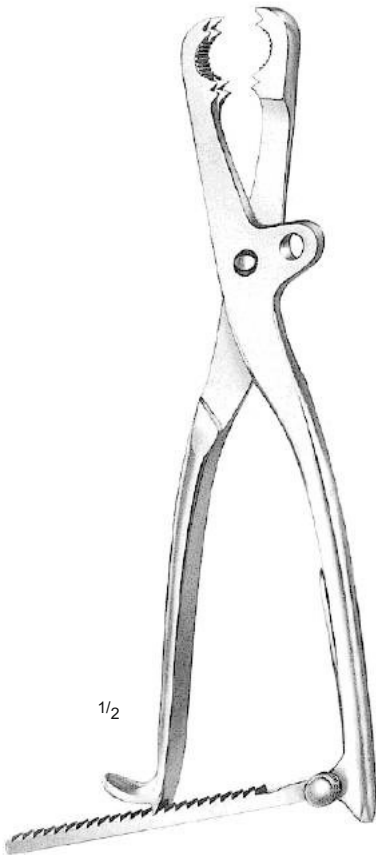
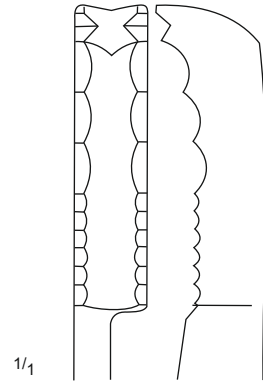
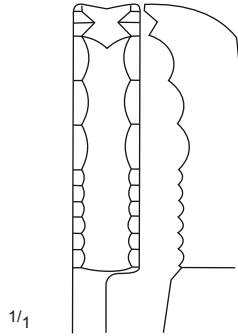
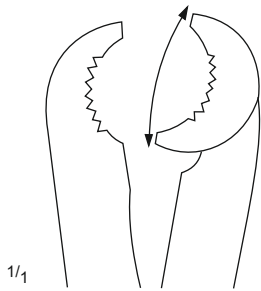

LAMBOTTE
SF-01-11067 – 21 cm / 8¹/₄"
SF-01-11068 – 25 cm / 10"
SF-01-11069 – 30 cm / 12"



FARABEU
SF-01-11070 – 23 cm / 9"
SF-01-11071 – 25 cm / 10"

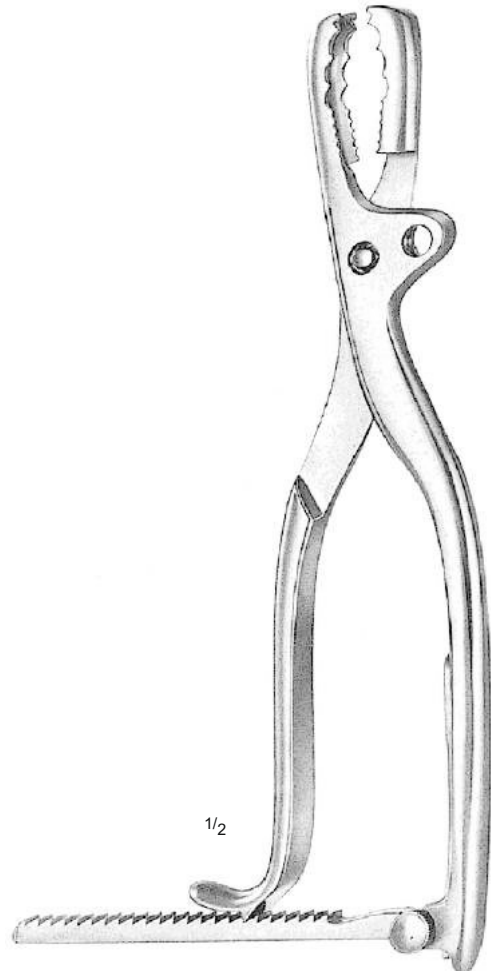

FARABEU - LAMBOTTE
SF-01-11072
26 cm / 10 ¹/₄"



1/3

LANGENBECK
SF-01-11077
23 cm / 9"



1/3

CHARRIERE
SF-01-11078 – 27 cm / 10³/₄"
Blade Length 15 cm / 6"

SF-01-11079 – 30 cm / 12"
Blade Length 20 cm / 8"

SF-01-11080 – 34 cm / 13¹/₂"
Blade Length 25 cm / 10"



1/4

SATERLEE
SF-01-11081
29 cm / 11¹/₂"
Blade Length 21 cm / 8¹/₄"



1/4

CHARRIERE
SF-01-11082
35 cm / 14"



GIGLI

SF-01-11083 – 30 cm / 12"
SF-01-11084 – 40 cm / 15³/₄"
SF-01-11085 – 50 cm / 19³/₄"
SF-01-11086 – 60 cm / 23³/₄"
SF-01-11087 – 70 cm / 27¹/₂"



GIGLI
SF-01-11088
(Pair of Handles)



1/1

SF-01-11089

SF-01-11090

SF-01-11091

with Tungsten Carbide, T/C

1/2

18 cm / 7"

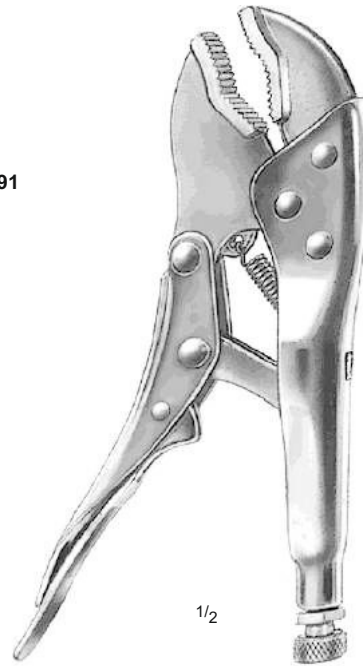

1/1

1/2

SF-01-11092

18 cm / 7"



1/2

SF-01-11093
16 cm / 6 1/4"



1/2

SF-01-11094
18 cm / 7"

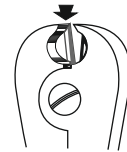

For hard wires
upto \varnothing 1.5 mm

For soft wires
upto \varnothing 2.0 mm

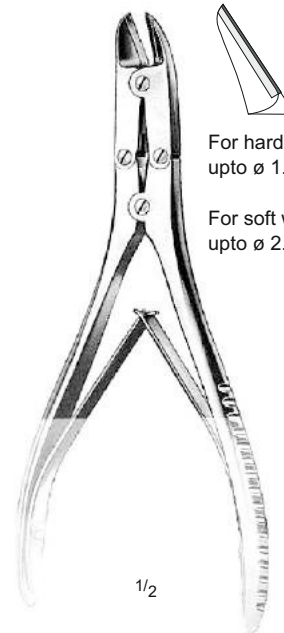

1/2

SF-01-11095
17 cm / 6 3/4"



For hard wires
upto \varnothing 1.6 mm

For soft wires
upto \varnothing 2.0 mm

Heavy
Pattern
Lateral
Cutting



T/C
SF-01-11096
24 cm / 9 1/2"

For Hard Wires
upto \varnothing 2.5 mm



T/C
SF-01-11097
22 cm / 8 3/4"

Front
Cutting
Double
Action

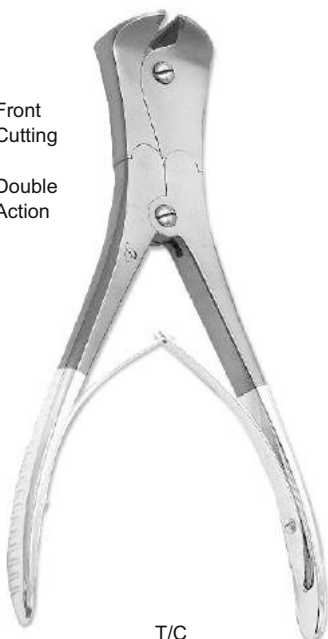

T/C
SF-01-11098
15 cm / 6"
SF-01-11099
23 cm / 9"

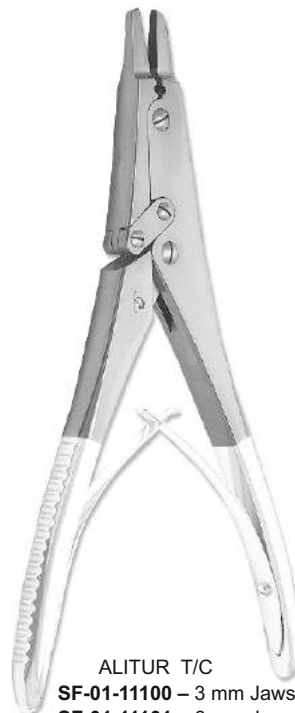

ALITUR T/C
SF-01-11100 – 3 mm Jaws
SF-01-11101 – 6 mm Jaws
18 cm / 7"



MEGA CUT
SF-01-11102
47 cm / 17 3/4"
For cutting off
Kirschner wires,
Tibia head screws
bolts, pins upto
6.0 mm \varnothing

SF-01-11103
56 cm / 22 1/2"
T/C
For hard wires
upto \varnothing 2.5 mm

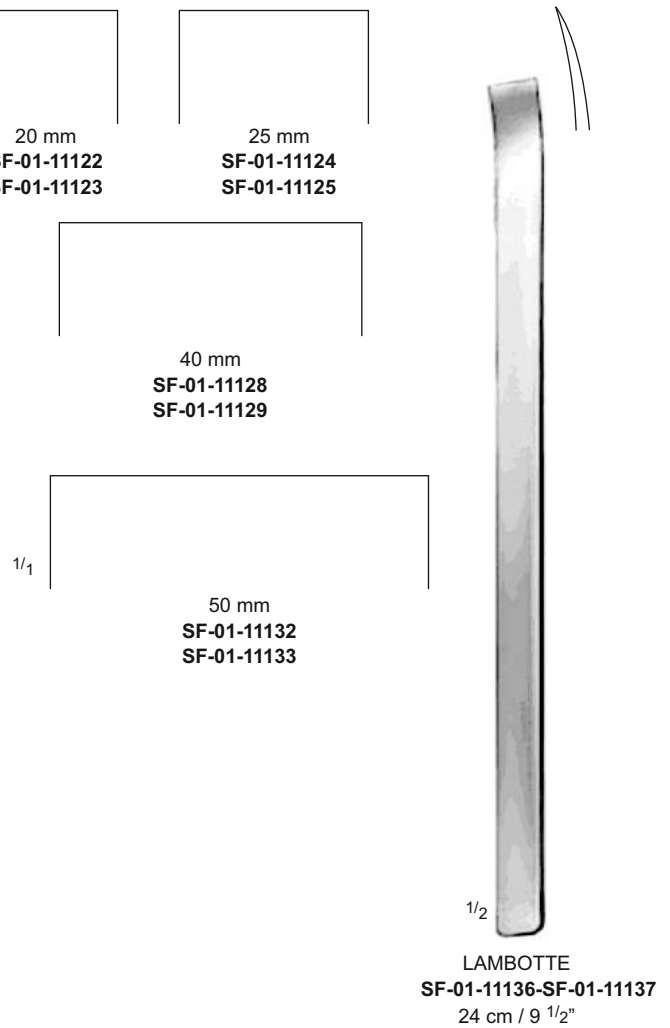
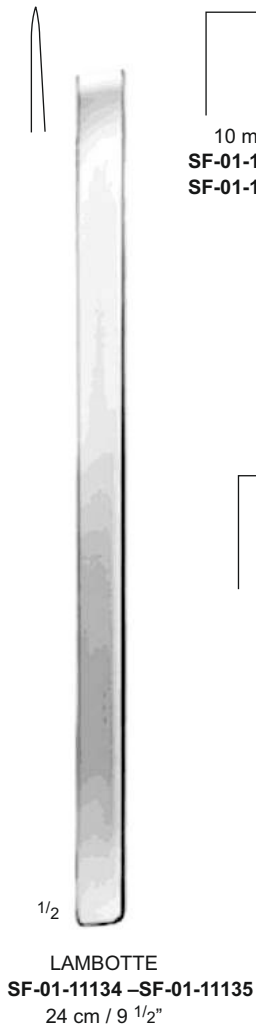
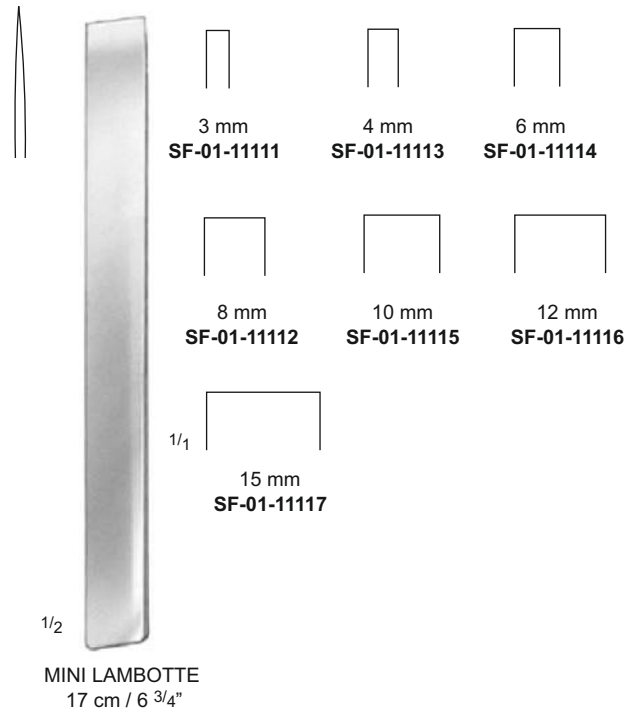
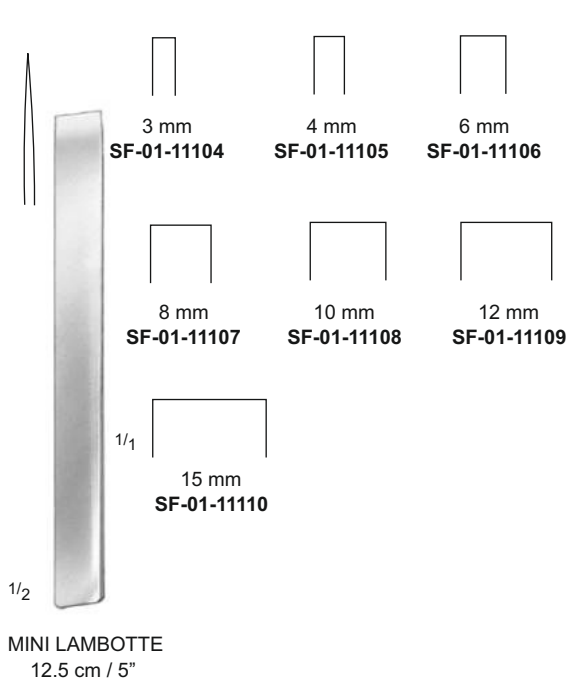

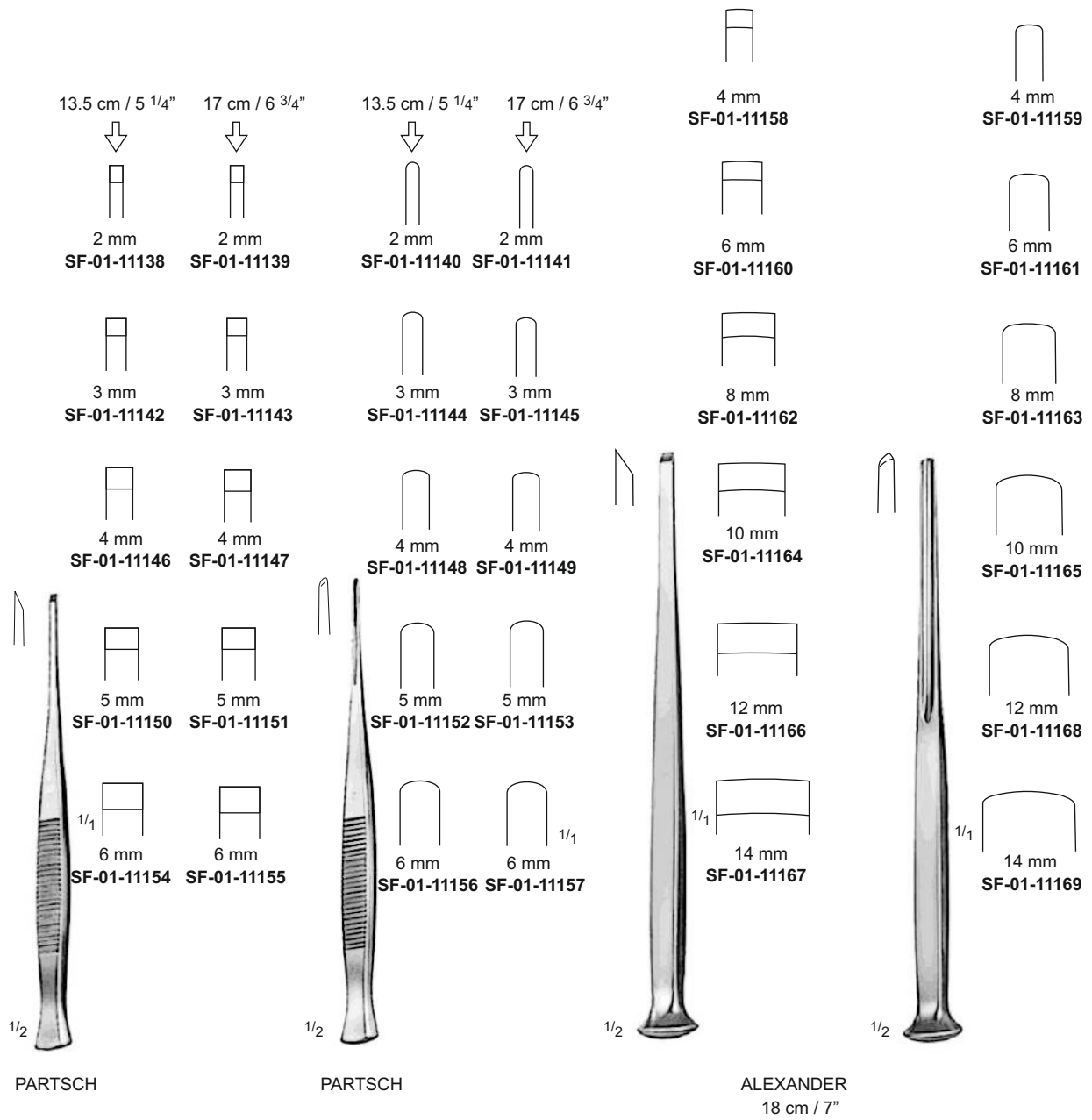



10 mm
SF-01-11170



10 mm
SF-01-11171



10 mm
SF-01-11180

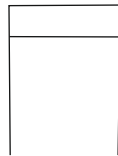

15 mm
SF-01-11173



15 mm
SF-01-11174

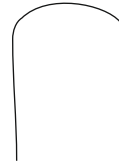

15 mm
SF-01-11181

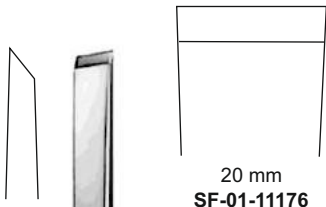

20 mm
SF-01-11176

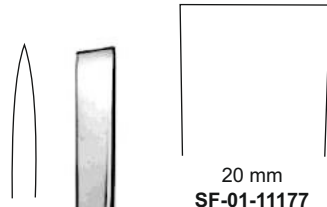

20 mm
SF-01-11177

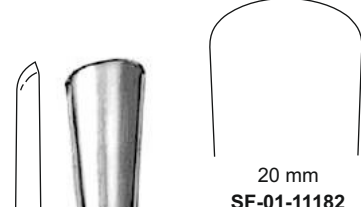

20 mm
SF-01-11182

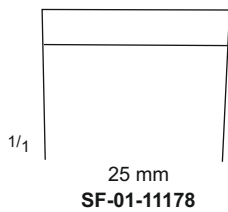

1/1
25 mm
SF-01-11178

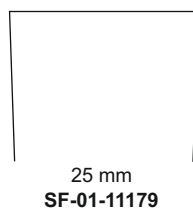

1/1
25 mm
SF-01-11179

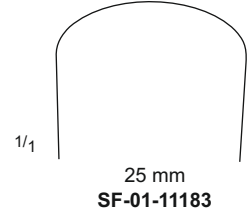

1/1
25 mm
SF-01-11183



1/2
STILLE
20 cm / 8"



1/2
STILLE
20 cm / 8"



1/2
STILLE
20 cm / 8"

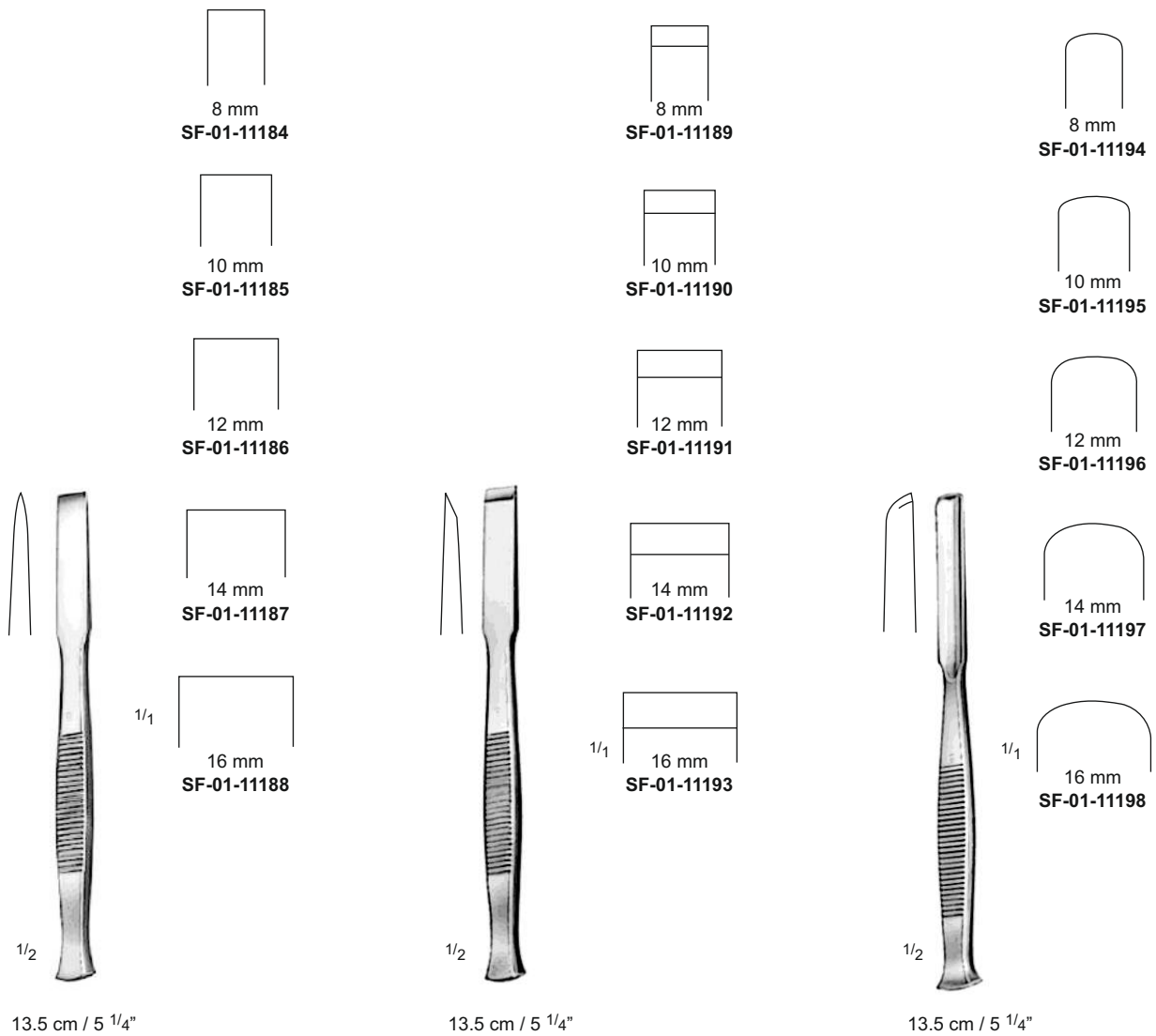

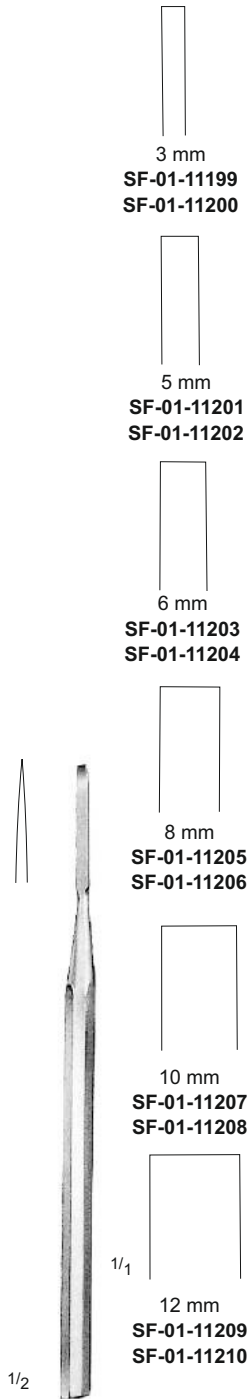

3 mm
SF-01-11199
SF-01-11200

5 mm
SF-01-11201
SF-01-11202

6 mm
SF-01-11203
SF-01-11204

8 mm
SF-01-11205
SF-01-11206

10 mm
SF-01-11207
SF-01-11208

12 mm
SF-01-11209
SF-01-11210

HOKE
SF-01-11211- SF-01-11212
14 cm / 5 1/2"

SF-01-11213 - SF-01-11214
17 cm / 6 3/4"

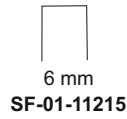

6 mm
SF-01-11215



13 mm
SF-01-11216



19 mm
SF-01-11217

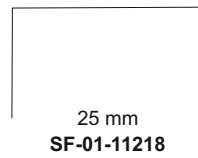

25 mm
SF-01-11218

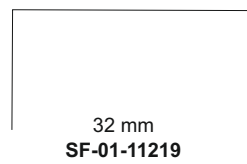

32 mm
SF-01-11219



HIBBS
24 cm / 9 1/2"

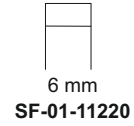

6 mm
SF-01-11220

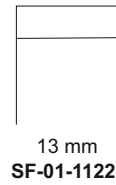

13 mm
SF-01-11221

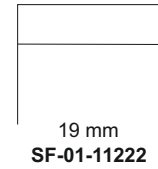

19 mm
SF-01-11222

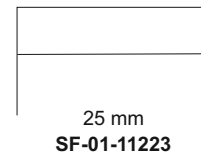

25 mm
SF-01-11223

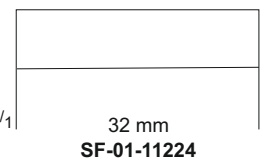

32 mm
SF-01-11224



HIBBS
24 cm / 9 1/2"

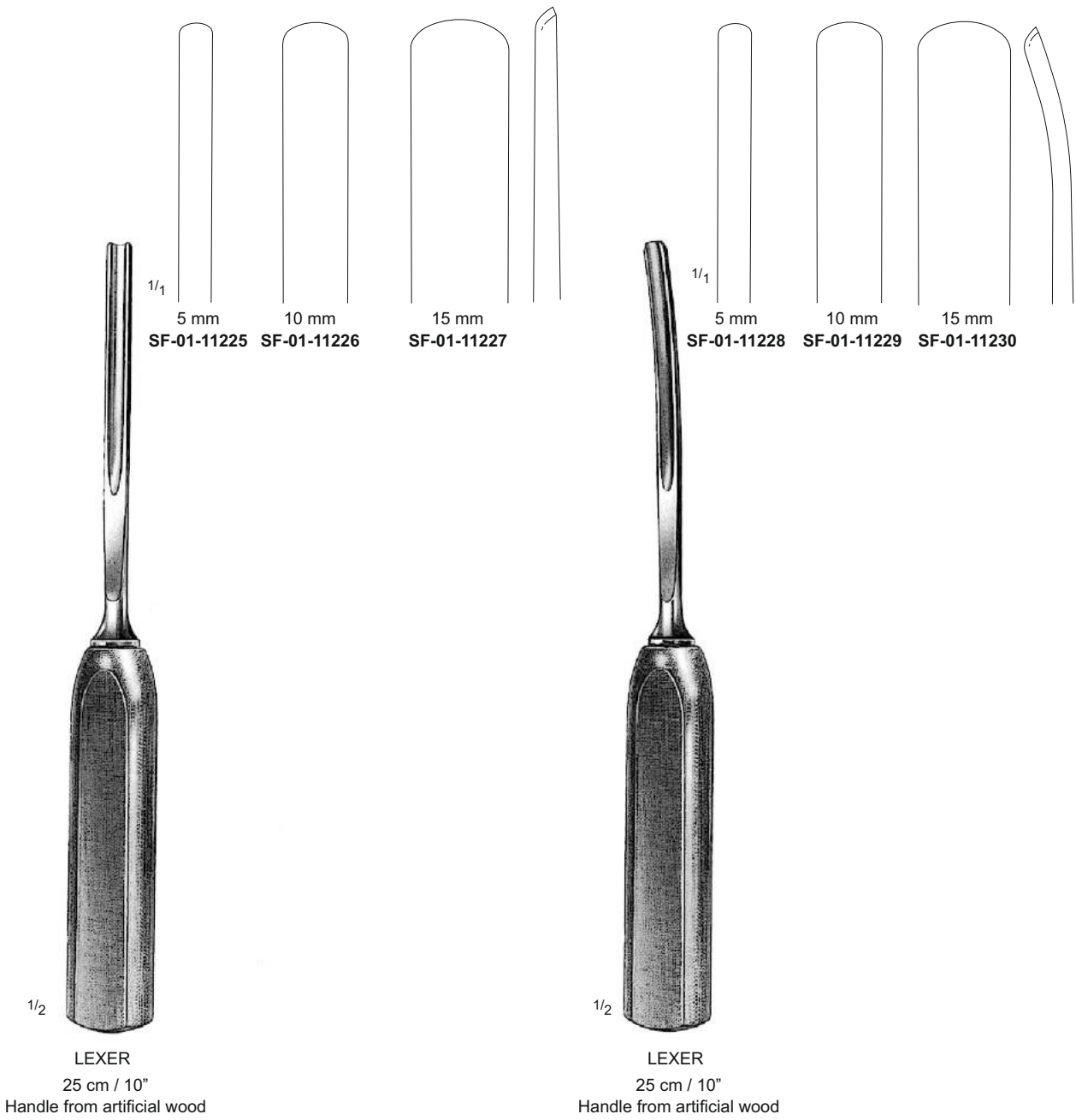

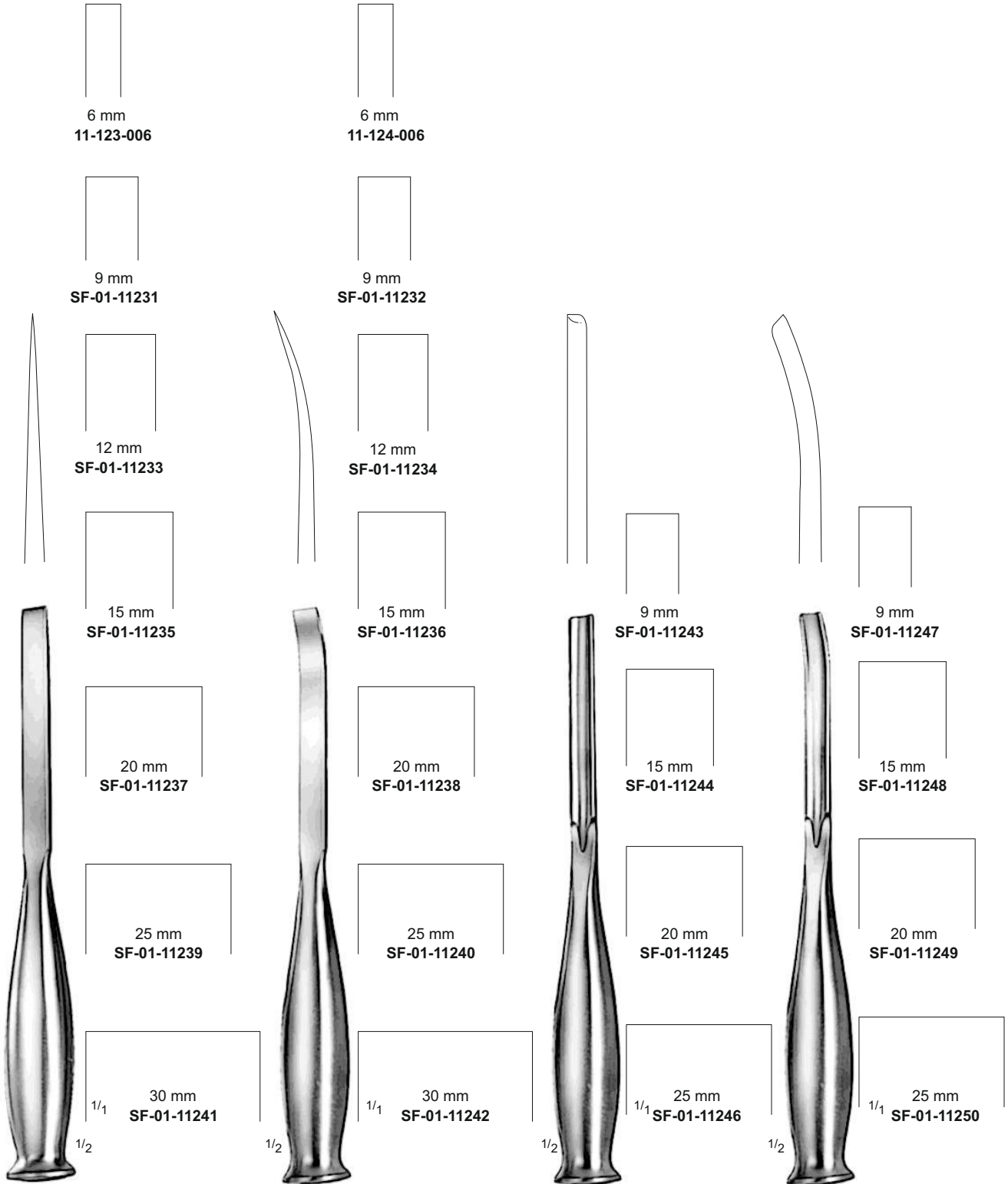

SMITH - PETERSON
20 cm / 8"

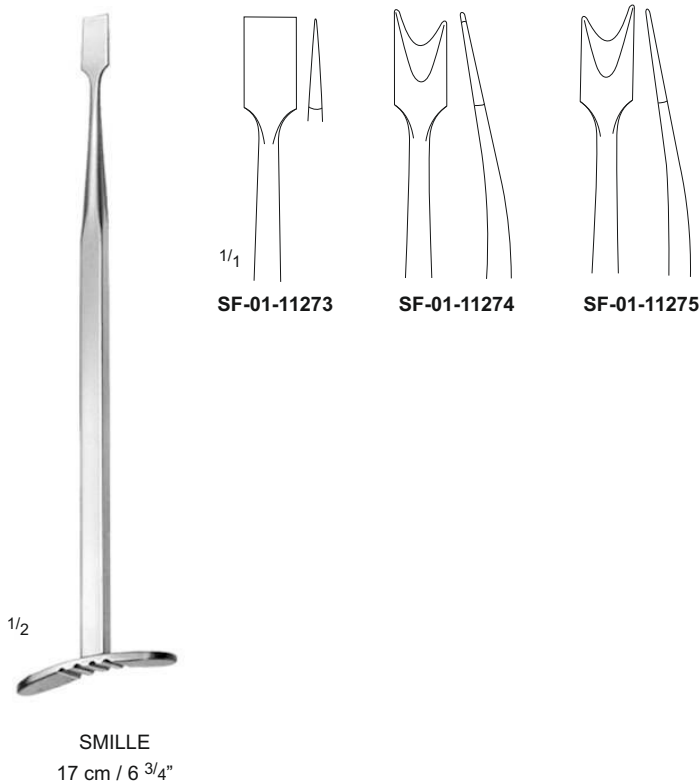
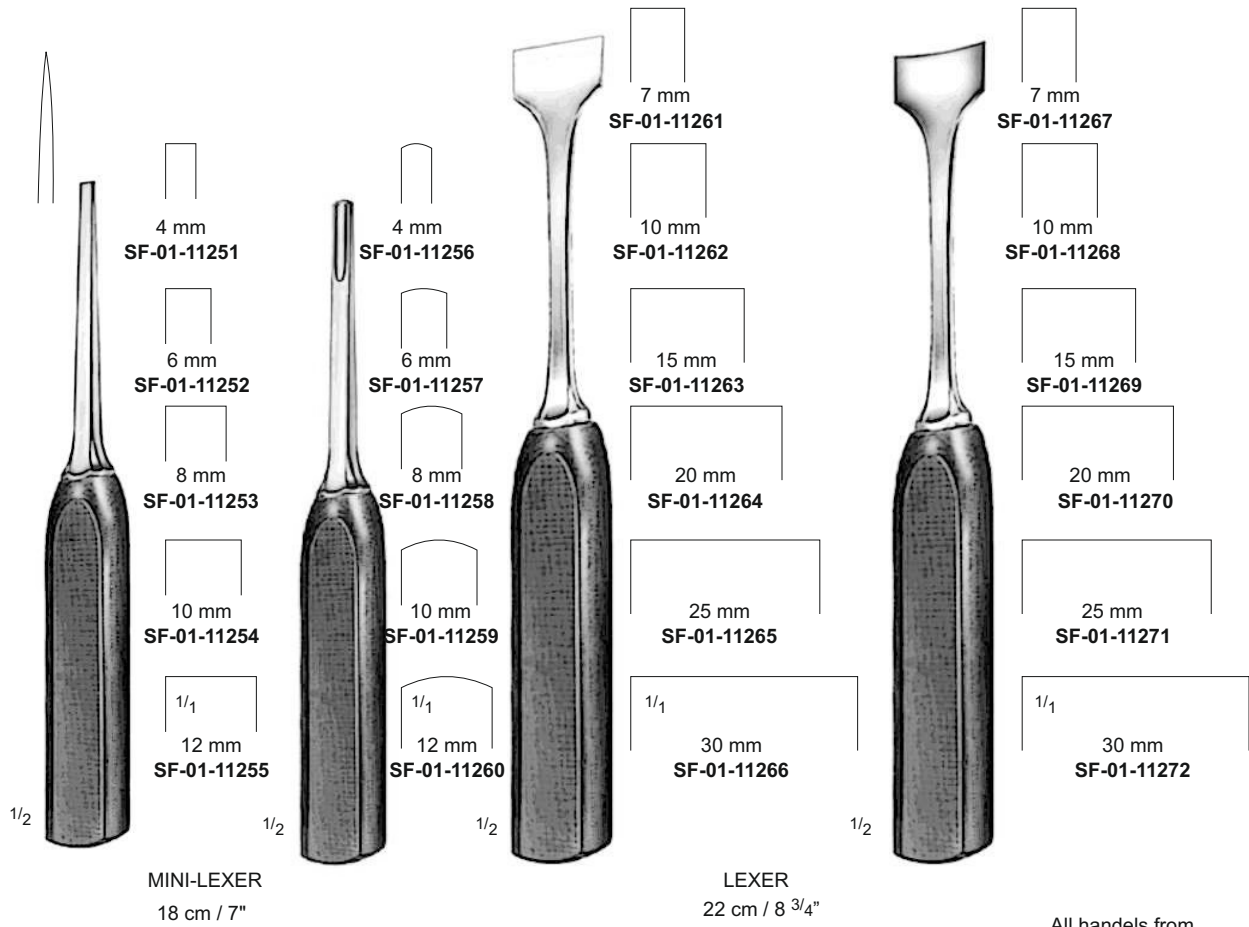



SF-01-11276
Fig. # 0000



SF-01-11277
Fig. # 000



SF-01-11278
Fig. # 00



SF-01-11279
Fig. # 0



SF-01-11280
Fig. # 1



SF-01-11281
Fig. # 2



SF-01-11282
Fig. # 3



SF-01-11283
Fig. # 4



$\frac{1}{1}$
SF-01-11284
Fig. # 5



$\frac{1}{2}$

BRUNS
23 cm / 9"



SF-01-11285
Fig. # 0000



SF-01-11290
Fig. # 2



SF-01-11295
Fig. # 0



SF-01-11286
Fig. # 000



SF-01-11291
Fig. # 3



SF-01-11296
Fig. # 1



SF-01-11287
Fig. # 00



SF-01-11292
Fig. # 4



SF-01-11297
Fig. # 2



SF-01-11288
Fig. # 0



SF-01-11293
Fig. # 5



SF-01-11298
Fig. # 3



$\frac{1}{1}$
SF-01-11289
Fig. # 1



SF-01-11294
Fig. # 6



$\frac{1}{1}$
SF-01-11299
Fig. # 4



$\frac{1}{2}$

BRUNS
27 cm / 10 $\frac{3}{4}$ "

All handels from
artificial wood



$\frac{1}{2}$

BRUNS
17 cm / 6 $\frac{3}{4}$ "

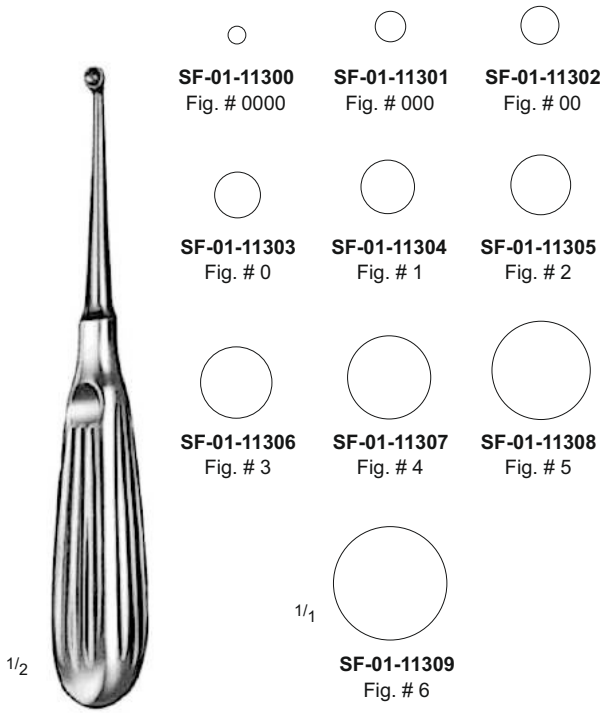

BRUNS
17 cm / 6 3/4"

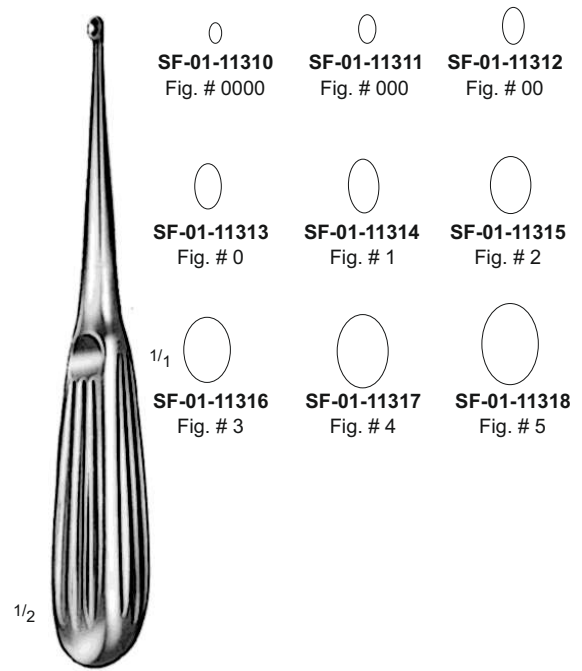

SPRATT
17 cm / 6 3/4"

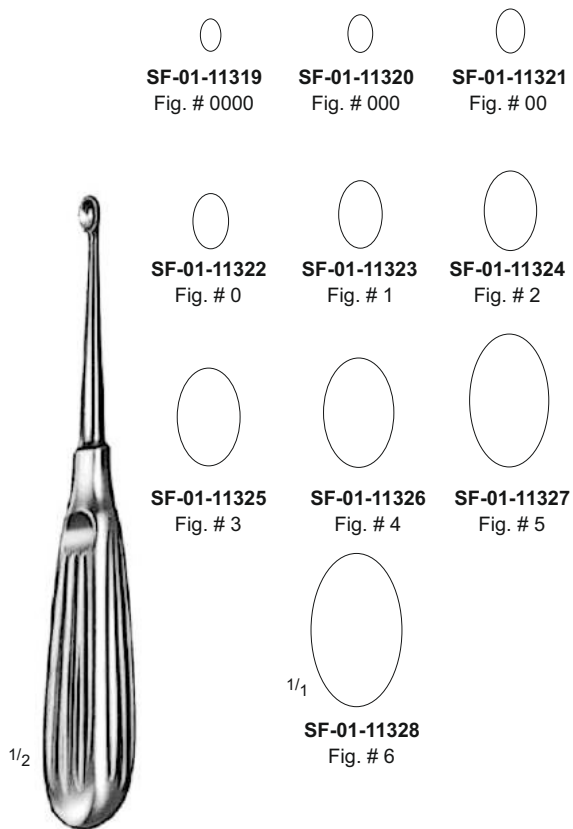

VOLKMANN
17 cm / 6 3/4"

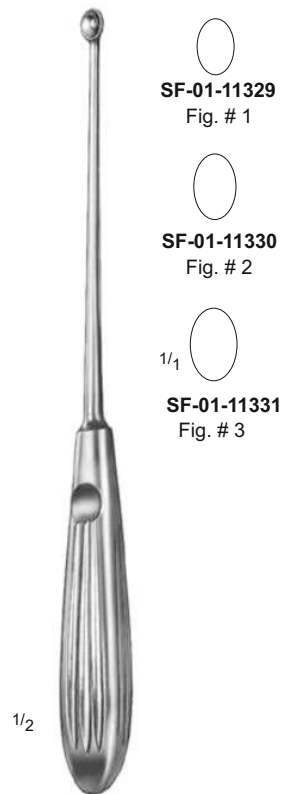

HALLE
21 cm / 8 1/4"

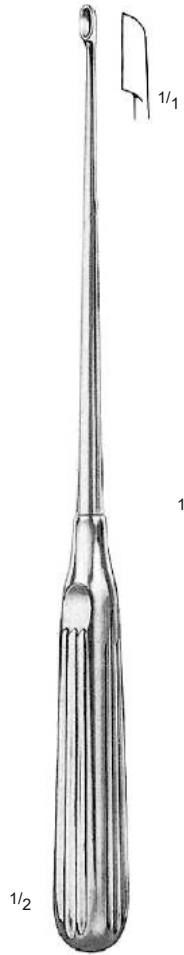

BRUNS-VOLKMANN
23 cm / 9"

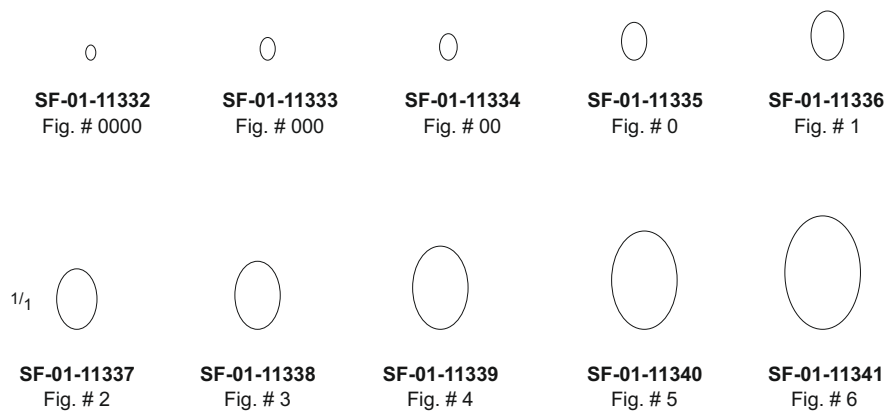

VOLKMANN

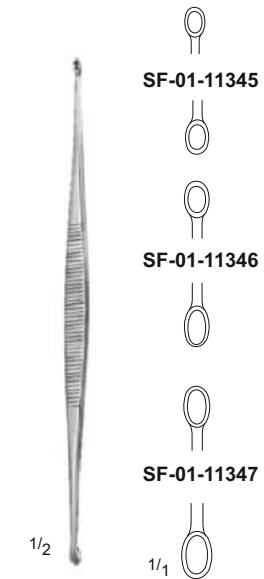
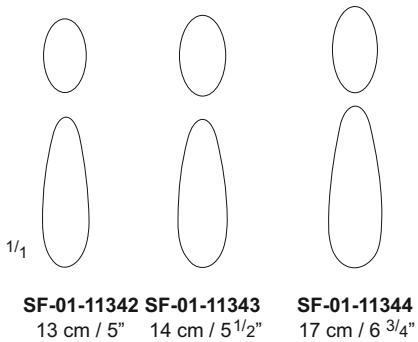

WILLIGER
13.5 cm / 5 1/4"

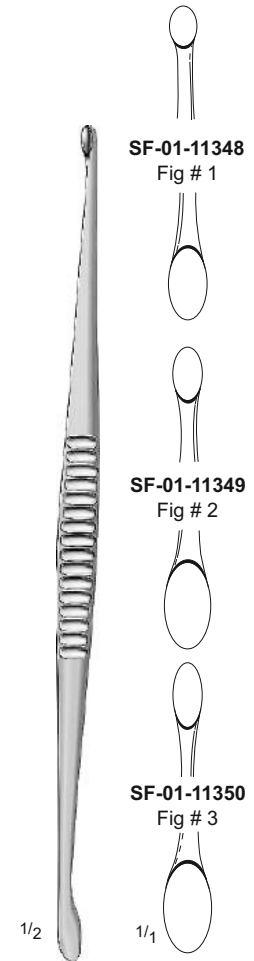

VOLKMANN
22 cm / 8 3/4"

Upper side of
Jaw Open

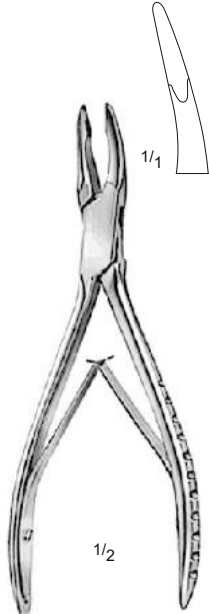

FREIDMANN
SF-01-11351
14 cm / 5 1/2"

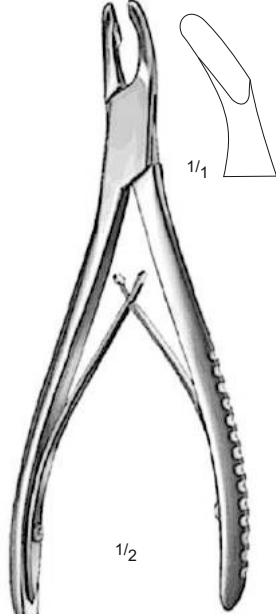

CLEVELAND
SF-01-11352
17 cm / 6 3/4"

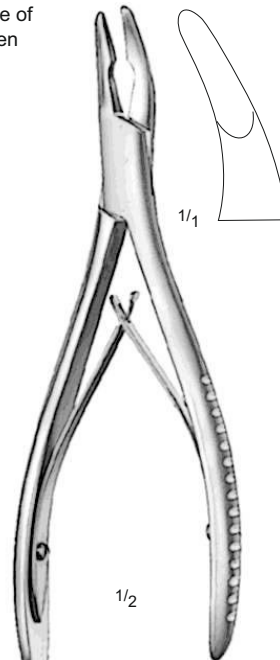

HARTMANN
SF-01-11353
19 cm / 7 1/2"

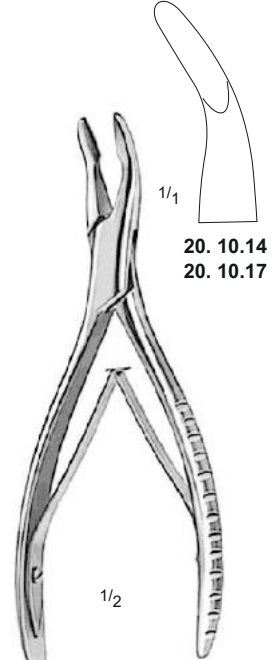

MEAD
SF-01-11354
14 cm / 5 1/2"
SF-01-11355
17 cm / 6 3/4"

20. 10.14
20. 10.17

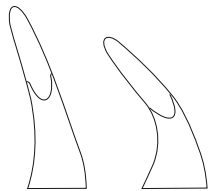

SF-01-11356 **SF-01-11357**

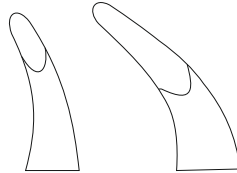

SF-01-11358 **SF-01-11359**



SF-01-11360
8 mm



SF-01-11361
8 mm



BLUMENTHAL
16 cm / 6 1/4"

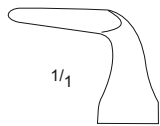

SF-01-11362



LUER
15 cm / 6"

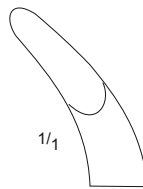

SF-01-11363

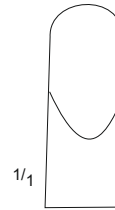

SF-01-11364
10 mm

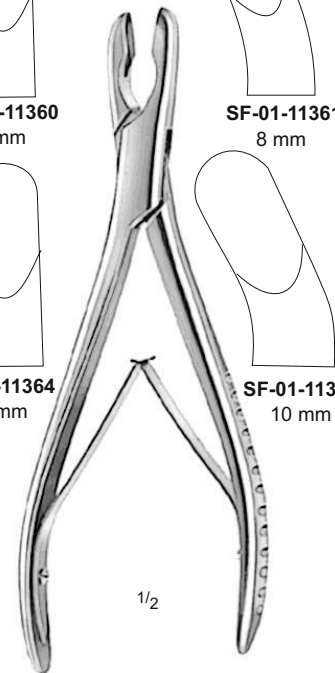

LUER
18 cm / 7"

SF-01-11365
10 mm

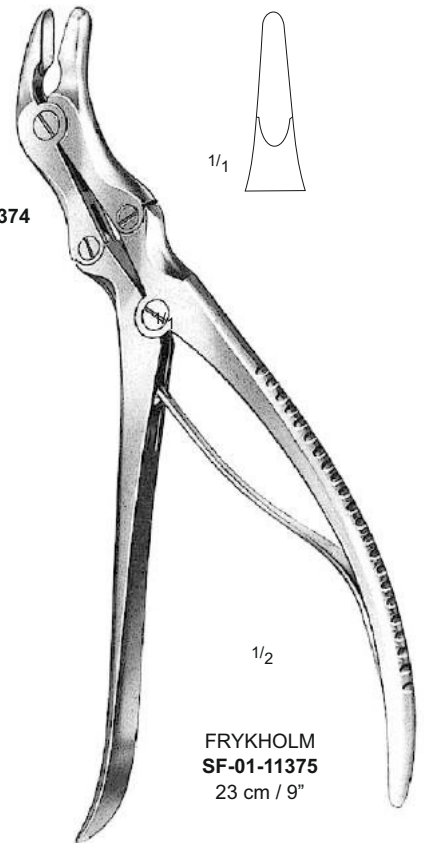
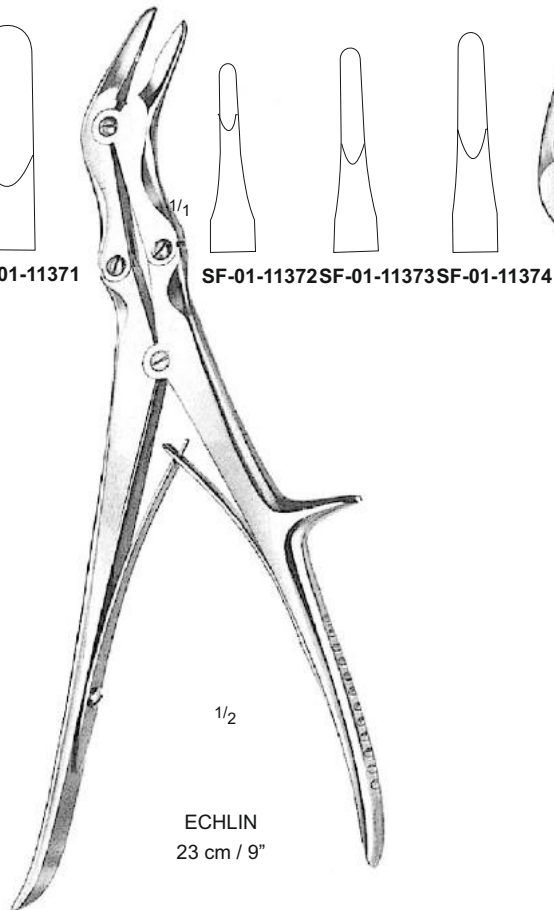
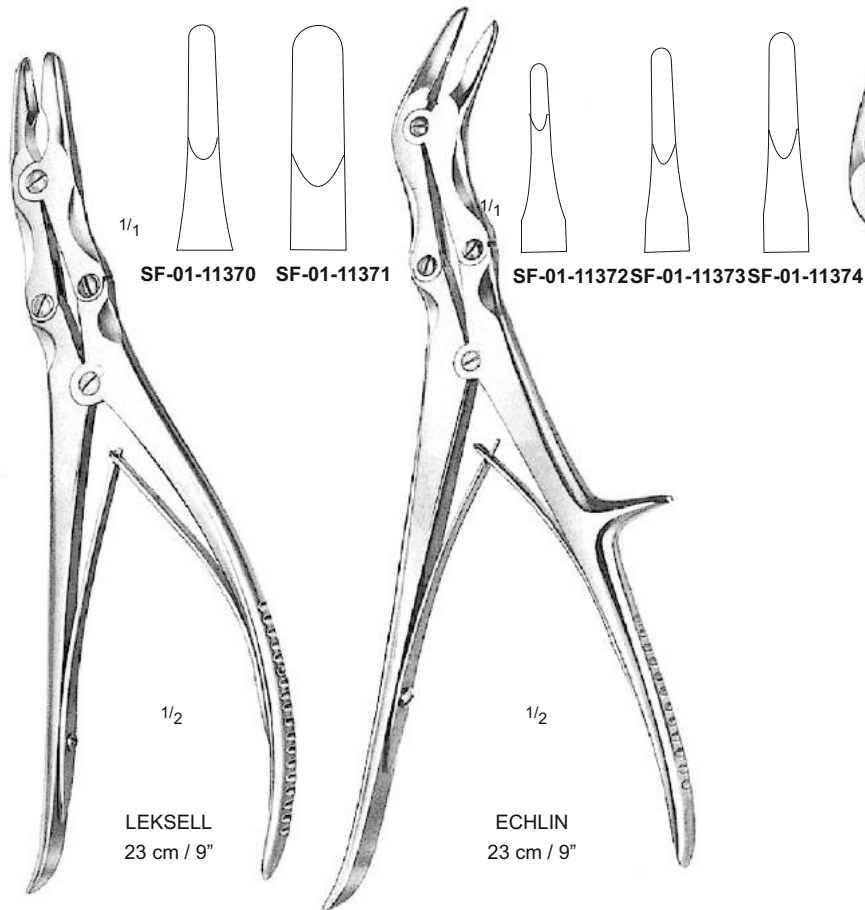
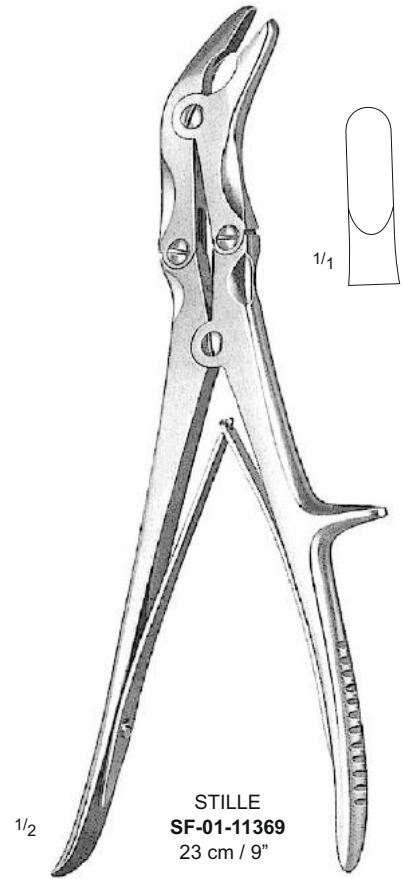
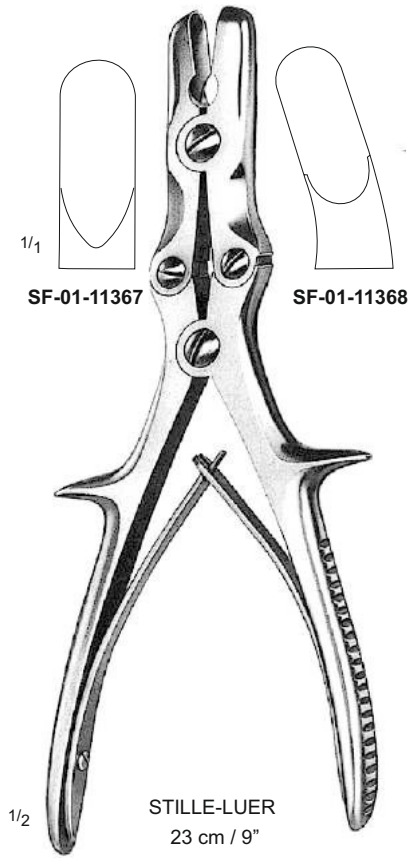
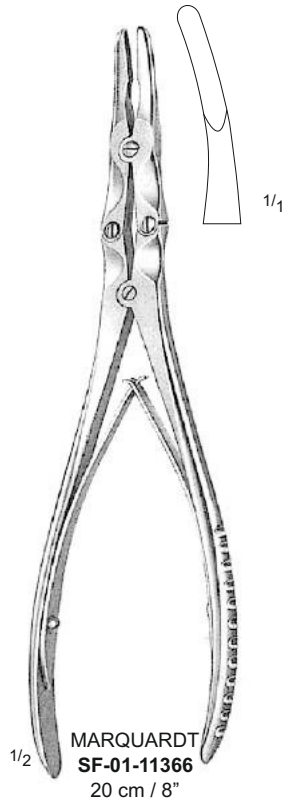

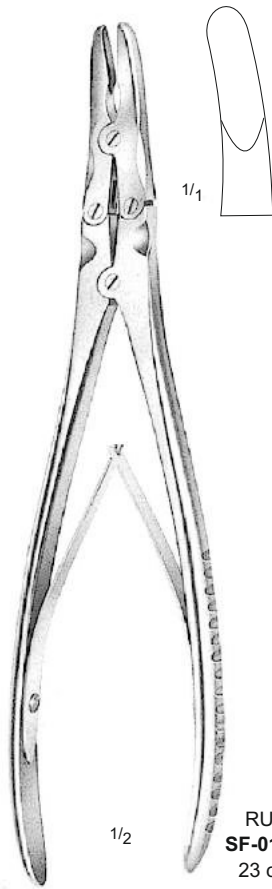

RUSKIN
SF-01-11376
23 cm / 9"

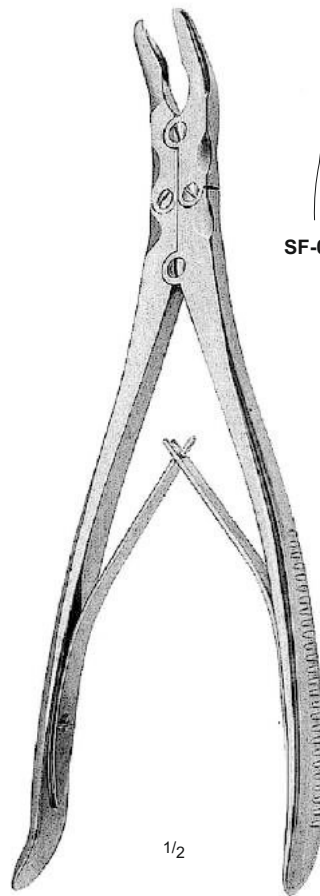

SMITH PETERSON
24 cm / 9 1/2"

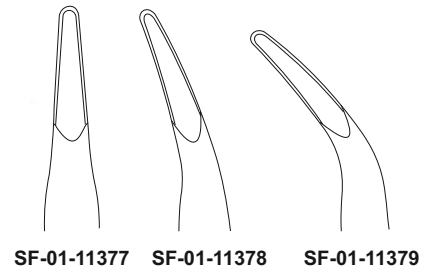

ZAUFAL-JANSEN
SF-01-11380
18 cm / 7"

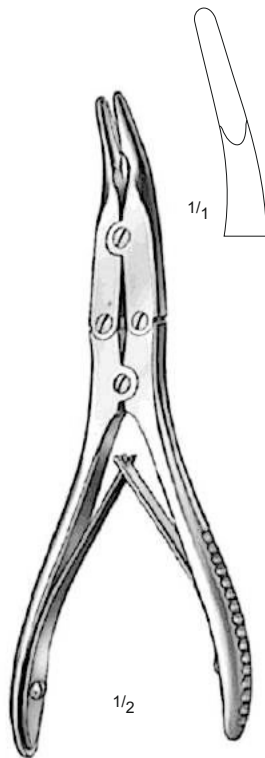

BEYER
SF-01-11381
18 cm / 7"

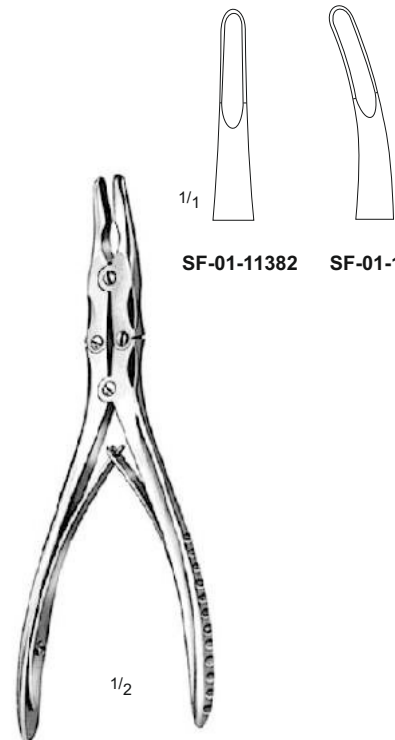

BOHLER
15 cm / 6"

SF-01-11382 SF-01-11383

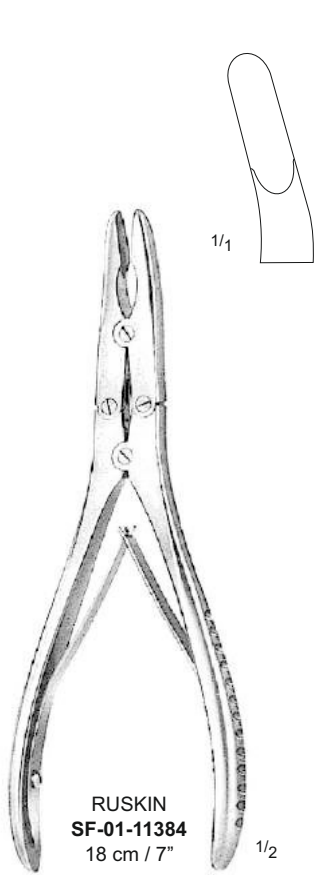

RUSKIN
SF-01-11384
18 cm / 7"

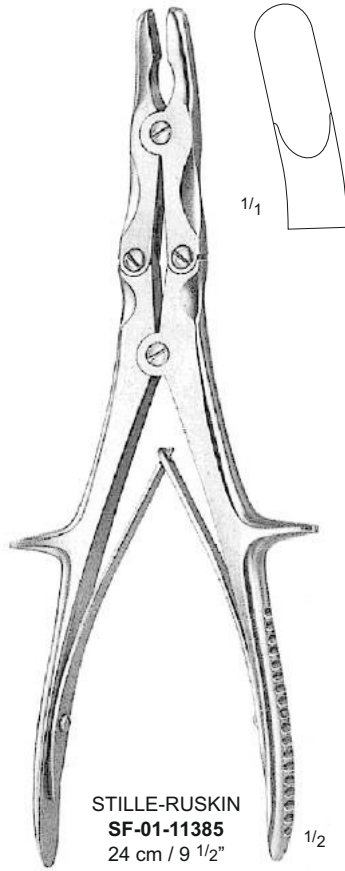

STILLE-RUSKIN
SF-01-11385
24 cm / 9 1/2"

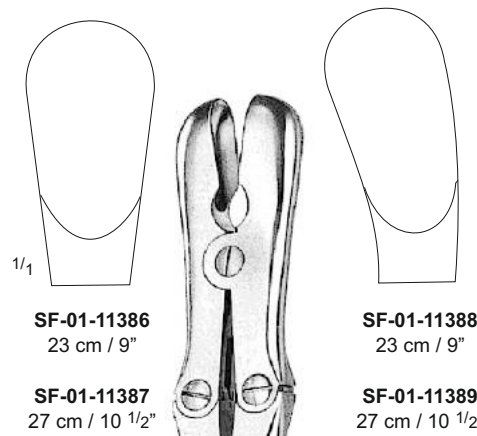

SF-01-11386
23 cm / 9"

SF-01-11388
23 cm / 9"

SF-01-11387
27 cm / 10 1/2"

SF-01-11389
27 cm / 10 1/2"

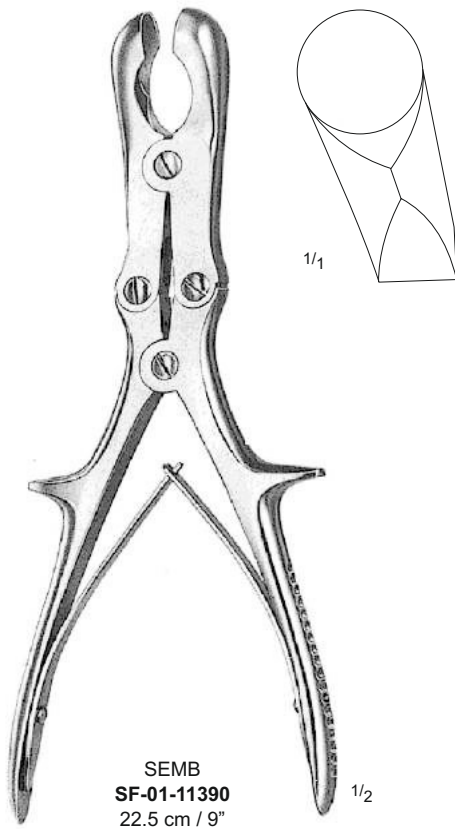

SEMB
SF-01-11390
22.5 cm / 9"

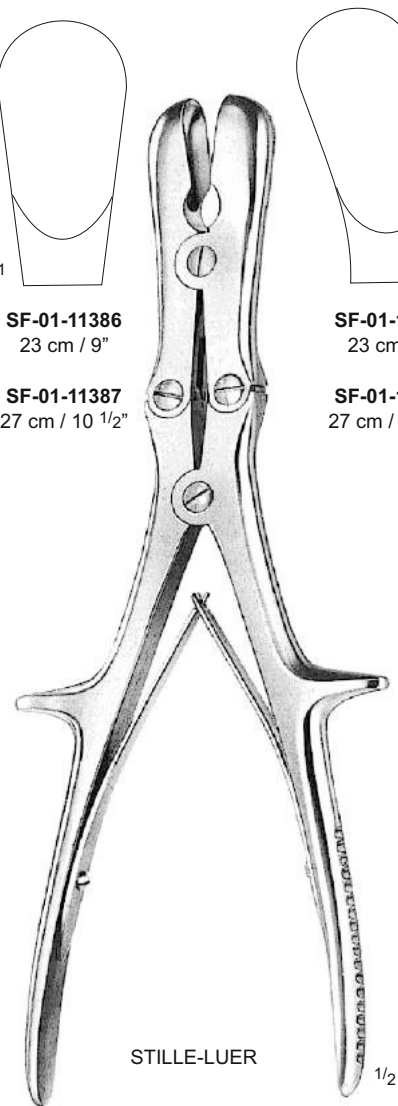

STILLE-LUER

Retractors



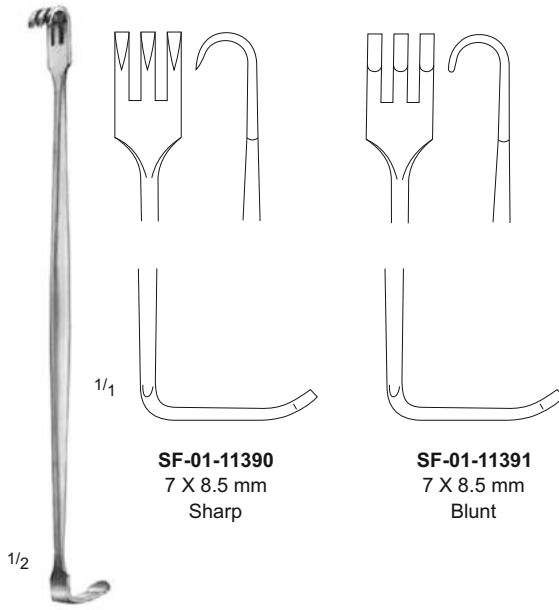

SF-01-11390
7 X 8.5 mm
Sharp

SF-01-11391
7 X 8.5 mm
Blunt

SEN MILLER
16 cm / 6 1/4"

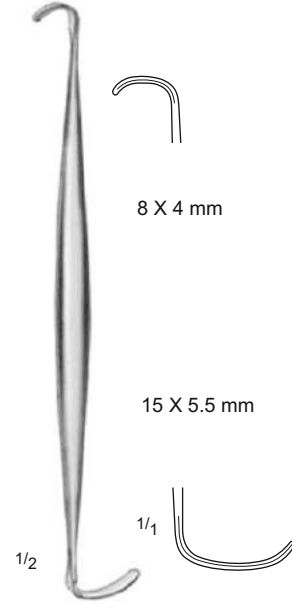

8 X 4 mm

15 X 5.5 mm

RAGNELL - DAVIS
SF-01-11392
16 cm / 6 1/4"

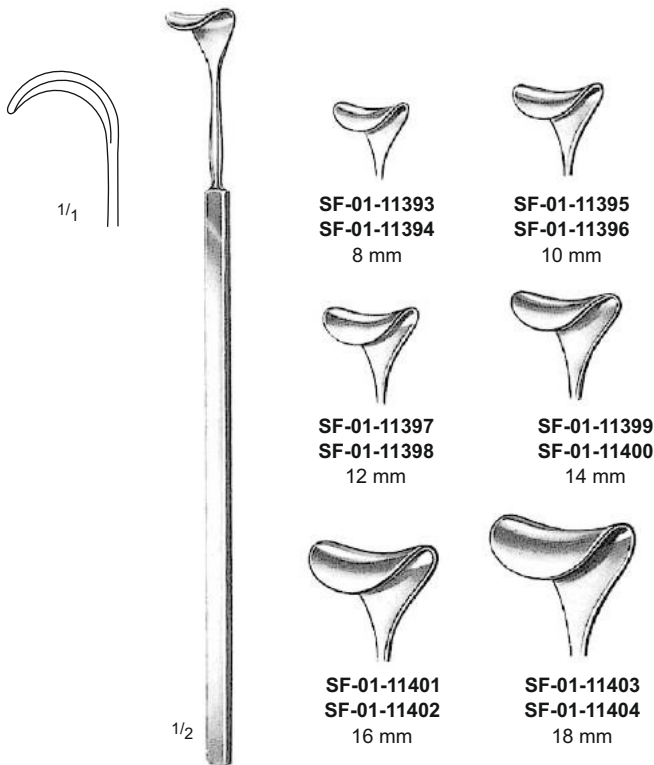

SF-01-11393
SF-01-11394
8 mm

SF-01-11395
SF-01-11396
10 mm

SF-01-11397
SF-01-11398
12 mm

SF-01-11399
SF-01-11400
14 mm

SF-01-11401
SF-01-11402
16 mm

SF-01-11403
SF-01-11404
18 mm

CUSHING
SF-01-11405 - SF-01-11406
20 cm / 8"

CUSHING
SF-01-11407 - SF-01-11408
24 cm / 9 1/2"

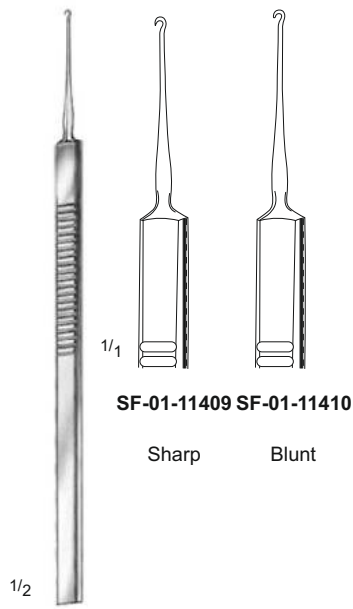

GRAEFE
16 cm / 6 1/4"

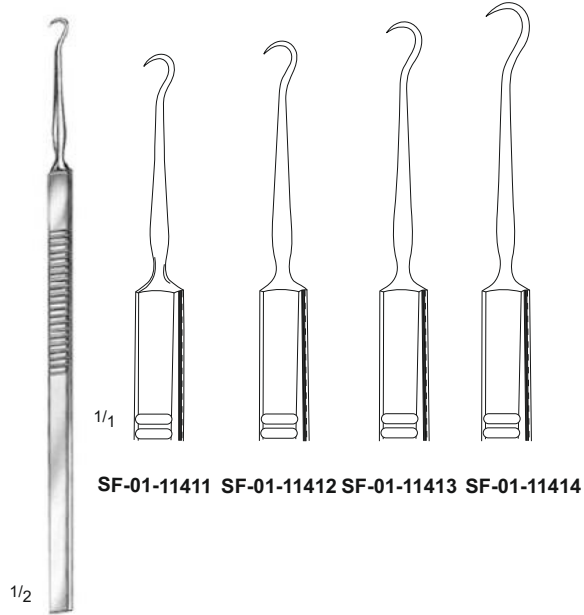

16 cm / 6 1/4"

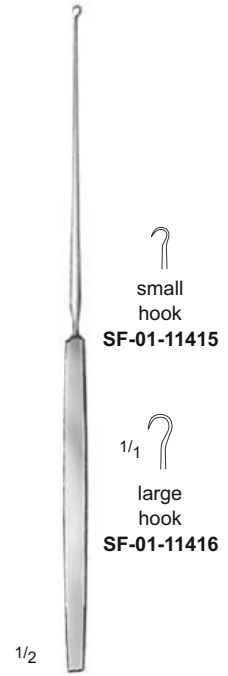

GILLIES
19 cm / 7 1/2"

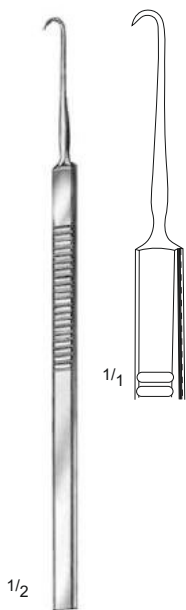

O'CONNOR
SF-01-11417
16 cm / 6 1/4"

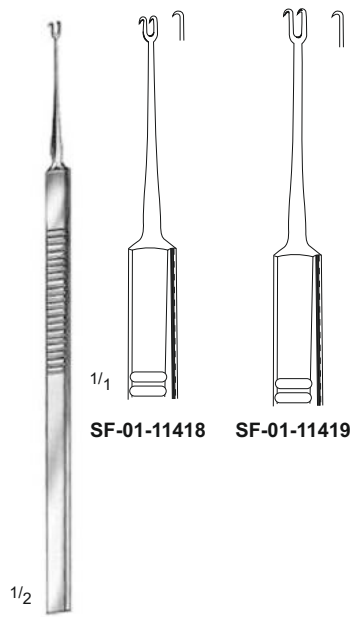

GUTHRIE
16 cm / 6 1/4"



SF-01-11420
16 cm / 6 1/4"

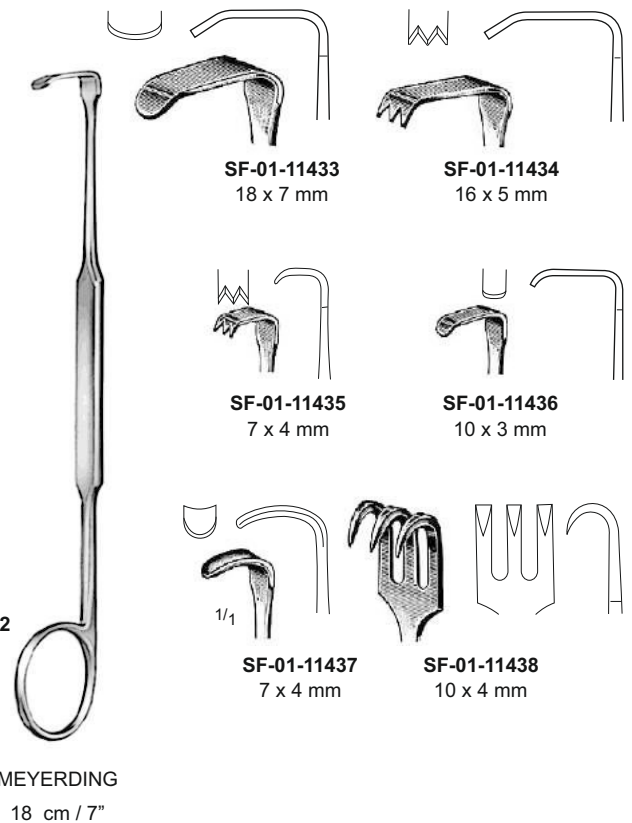
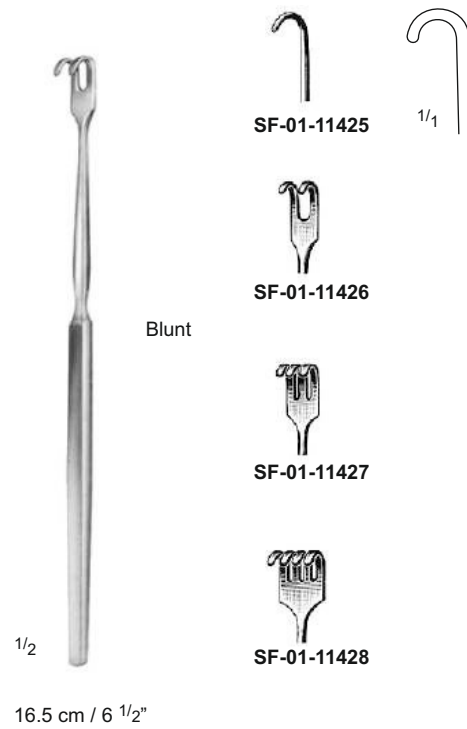
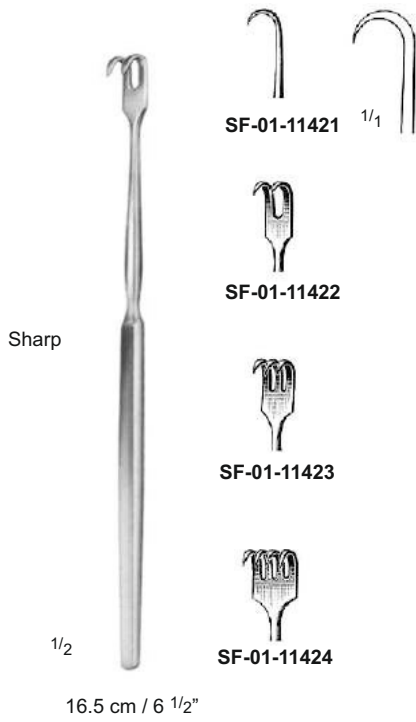

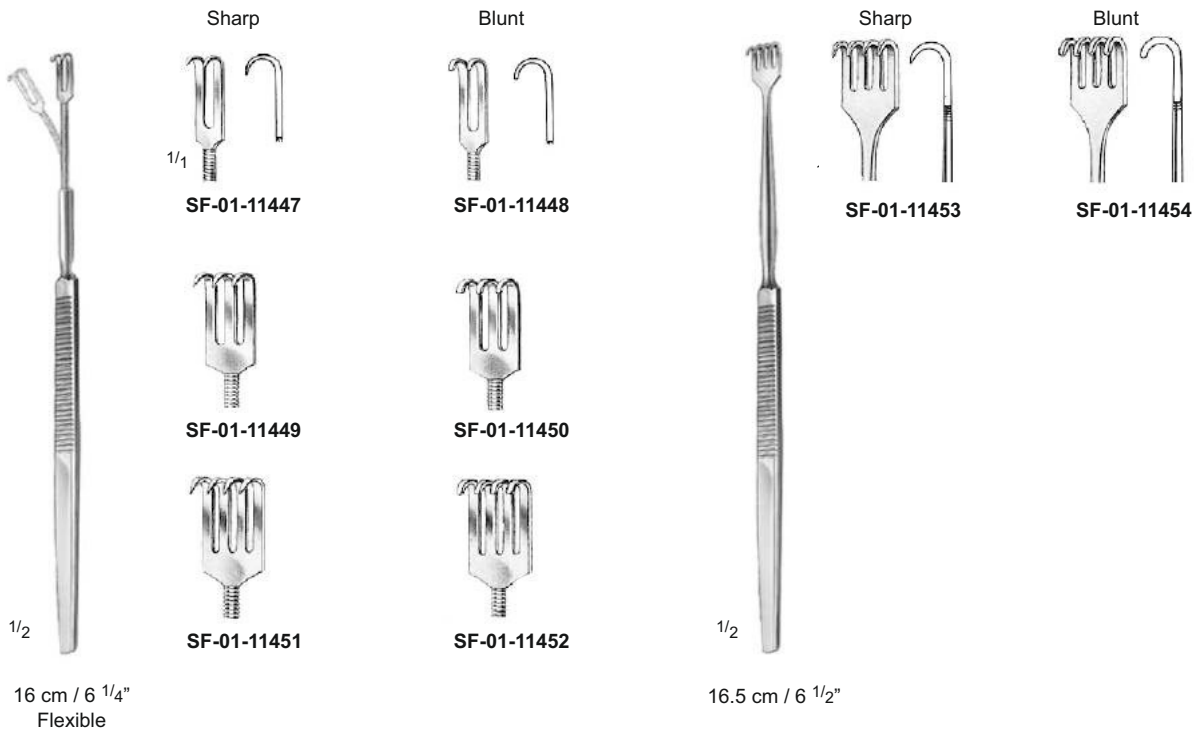
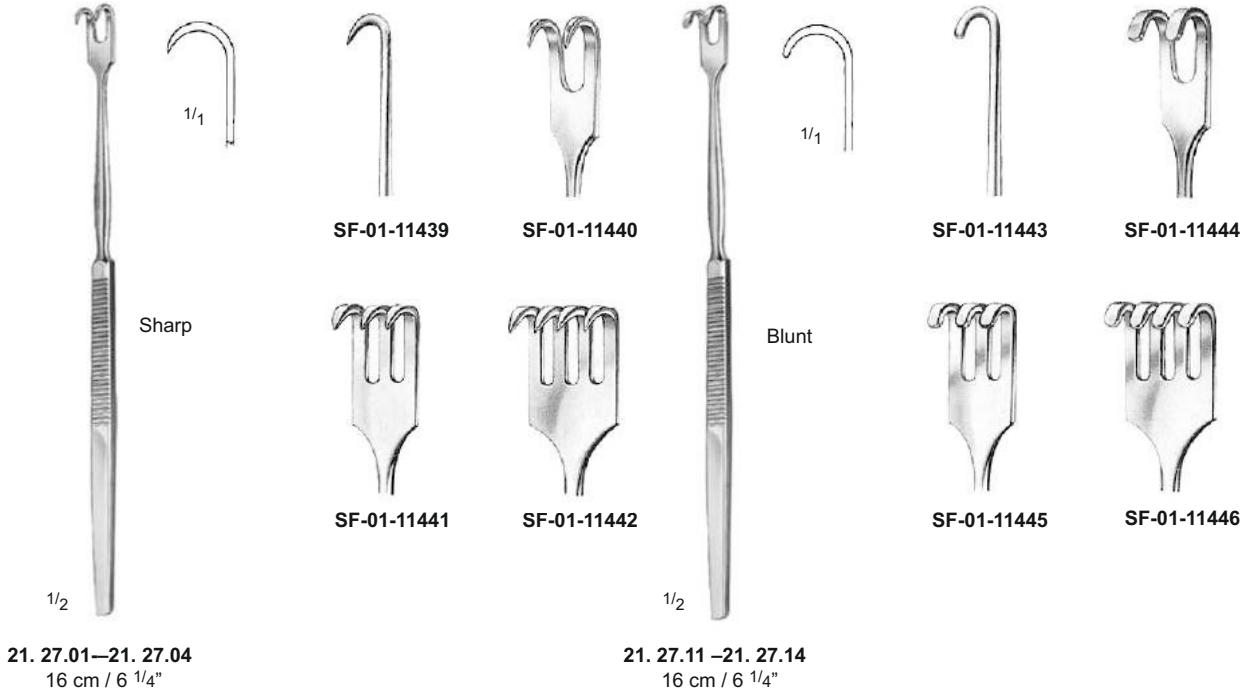



1/3

REVERDIN
SF-01-11455
28 cm / 11"
45 x 60 mm



1/3

OCHSNER
SF-01-11456 30 mm
SF-01-11457 40 mm
SF-01-11458 50 mm
33 cm / 13"

Flexible



HABERER
SF-01-11459
20 cm / 8", 17/25 mm
SF-01-11460
28 cm / 11", 25/30 mm
SF-01-11461
30 cm / 12", 37/45 mm

Flexible

Malleable and
very soft.



SF-01-11462 – 6 x 200 mm
SF-01-11463 – 10 x 200 mm
SF-01-11464 – 12 x 200 mm
SF-01-11465 – 17 x 200 mm
SF-01-11466 – 20 x 200 mm
SF-01-11467 – 25 x 200 mm
SF-01-11468 – 27 x 250 mm
SF-01-11469 – 35 x 250 mm

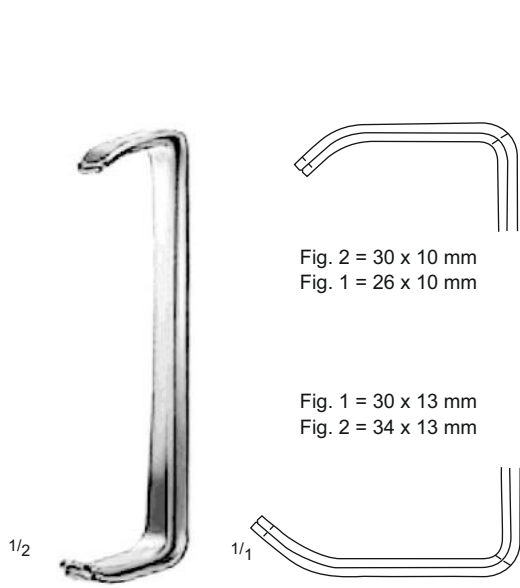

FARABEU
SF-01-11470 – Set of 2
12 cm / 4 3/4"

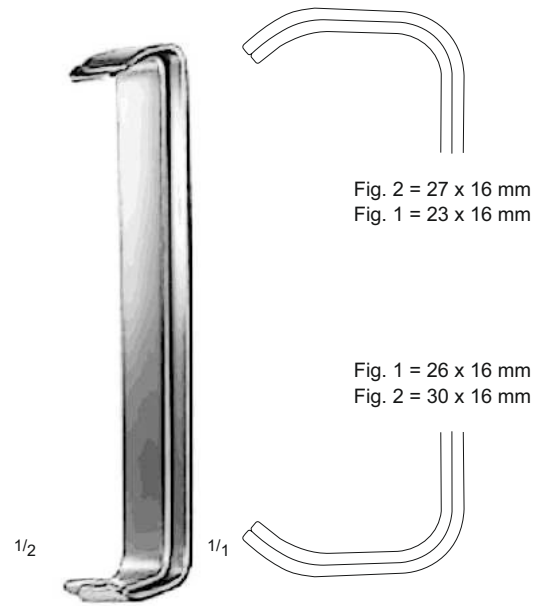

FARABEU
SF-01-11471 – Set of 2
15 cm / 6"

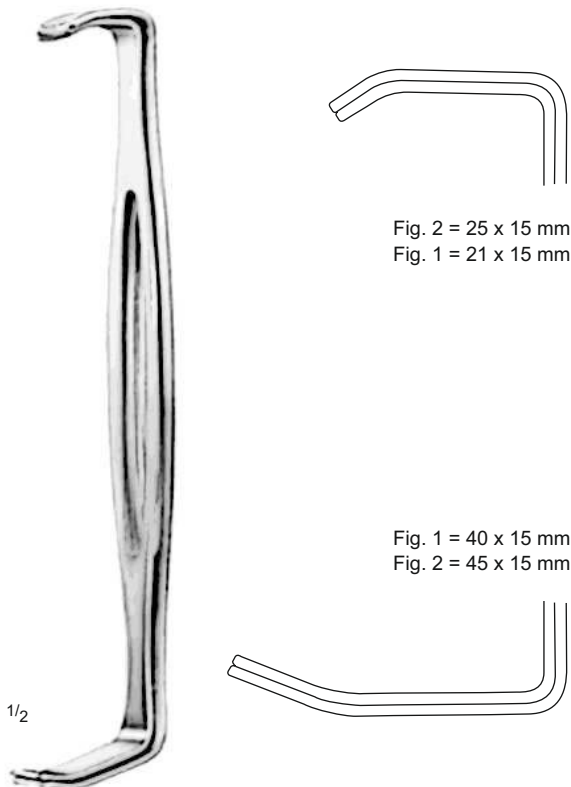

PARKER - LANGENBECK
SF-01-11472 – Set of 2
21 cm / 8 1/4"

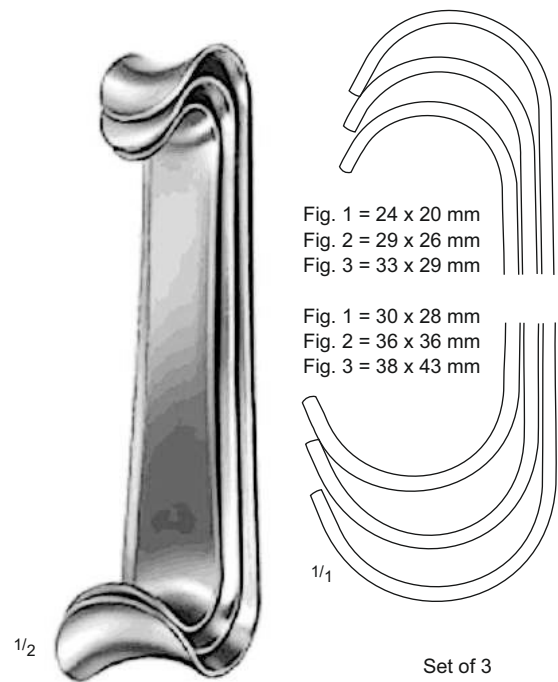

ROUX
SF-01-11473 – Fig 1 = 15 cm / 6"
SF-01-11474 – Fig 2 = 16 cm / 6 1/4"
SF-01-11475 – Fig 3 = 17 cm / 6 3/4"

Set of 3
21. 49.10

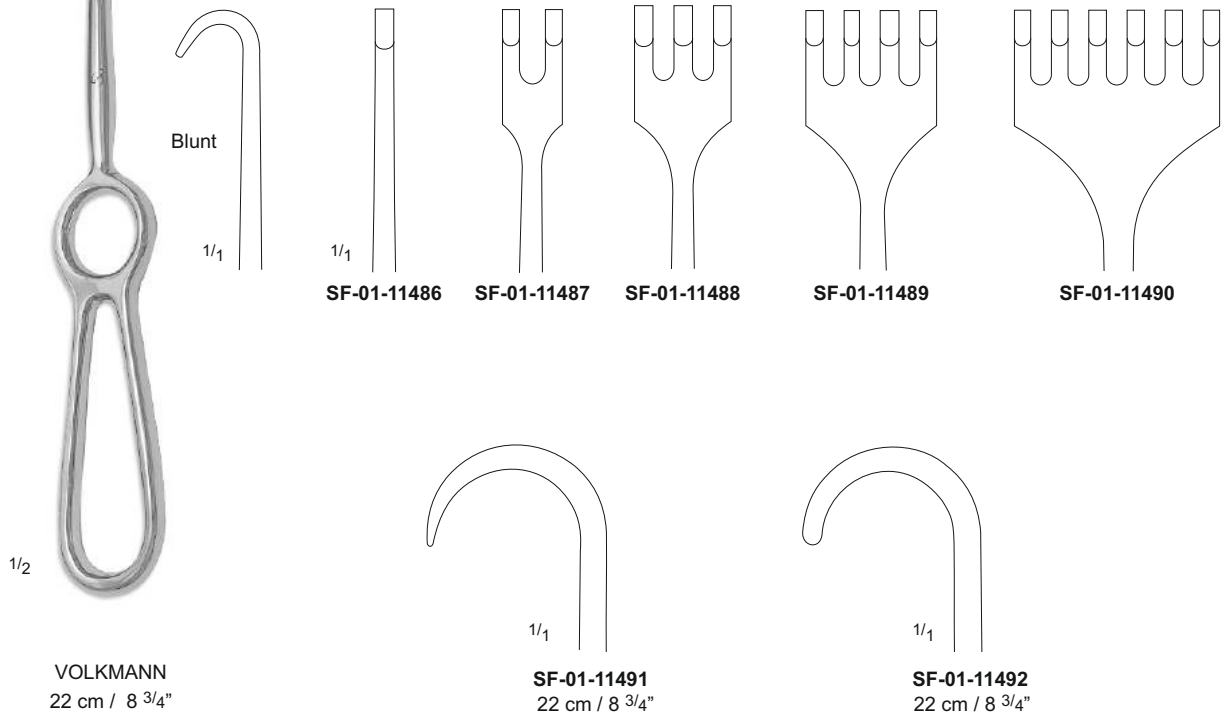
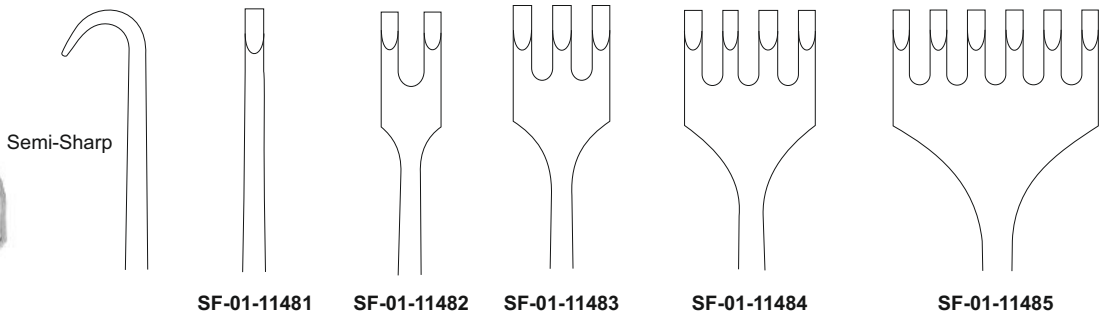
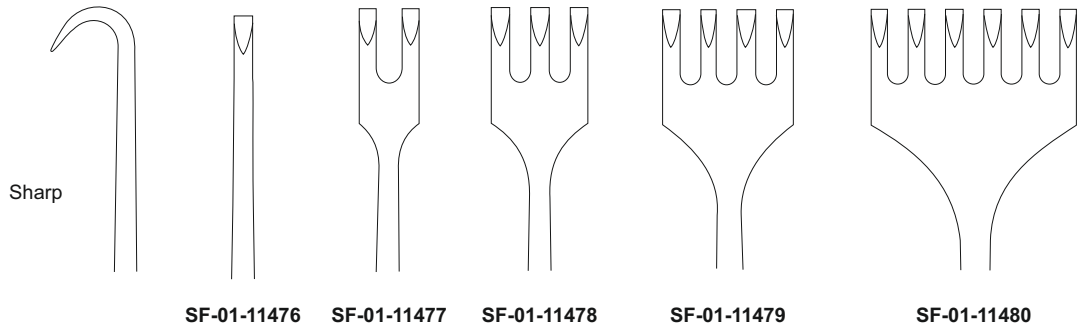

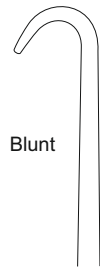

SF-01-11493

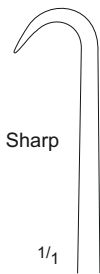
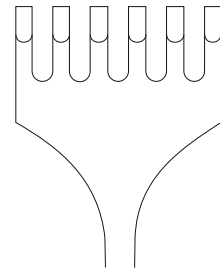
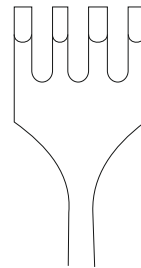
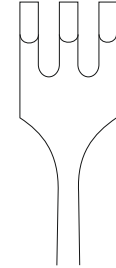
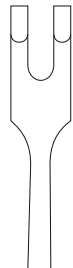

SF-01-11497

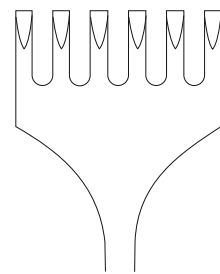
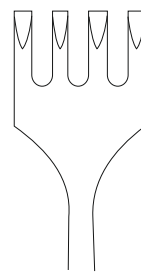
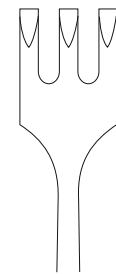
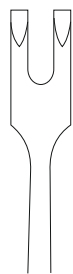

VOLKMANN
21.5 cm / 8 1/2"

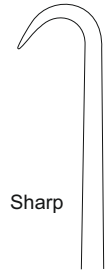

Sharp

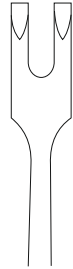

SF-01-11501

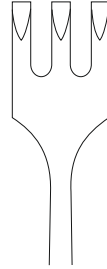

SF-01-11502

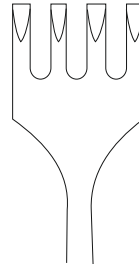

SF-01-11503

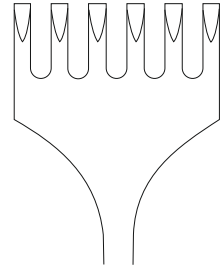

SF-01-11504

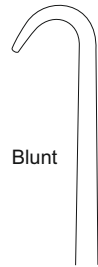

Blunt



SF-01-11505

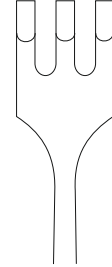

SF-01-11506

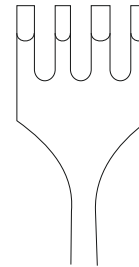

SF-01-11507

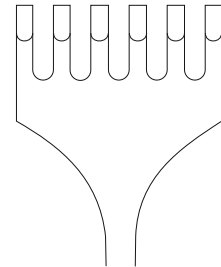

SF-01-11508

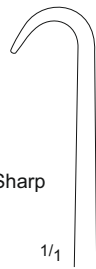

Semi Sharp

1/1



SF-01-11509

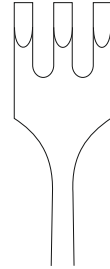

SF-01-11510

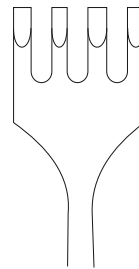

SF-01-11511

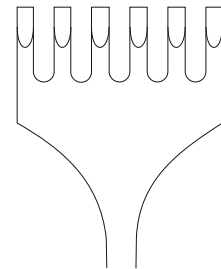

SF-01-11512



1/2

KOCHER
22 cm / 8 3/4"



LANGENBECK
21 cm / 8 1/4"

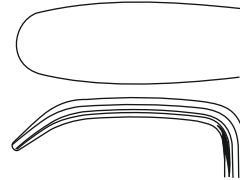

SF-01-11513
30 x 11 mm

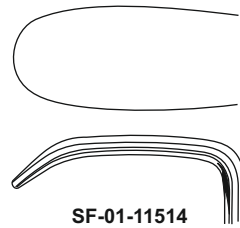

SF-01-11514
30 x 14 mm

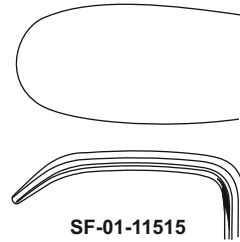

SF-01-11515
30 x 16 mm

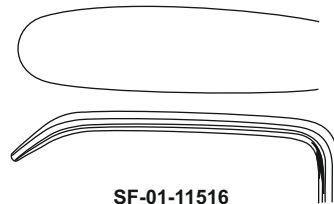

SF-01-11516
40 x 11 mm

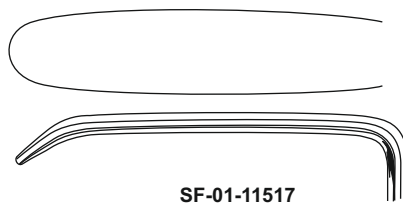

1/1 SF-01-11517
50 x 11 mm

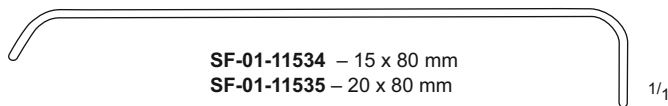
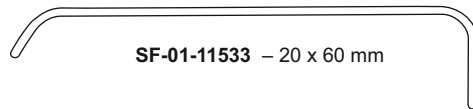
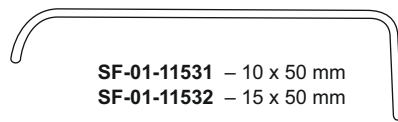
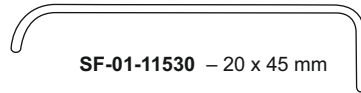
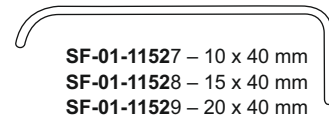
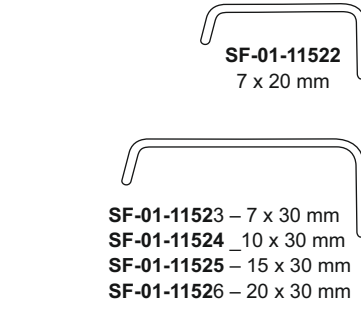
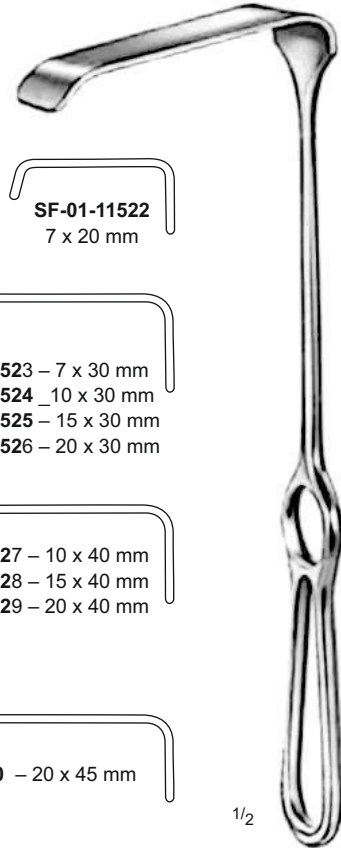
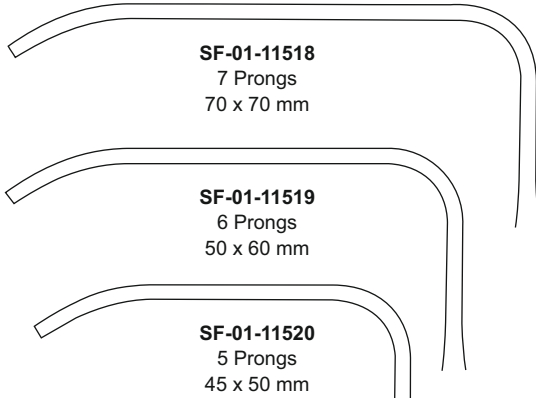

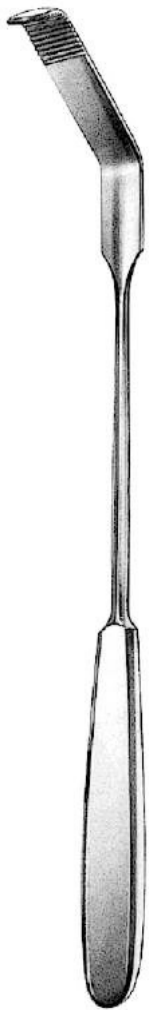

ZENKER

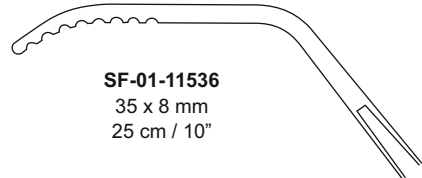

SF-01-11536
35 x 8 mm
25 cm / 10"

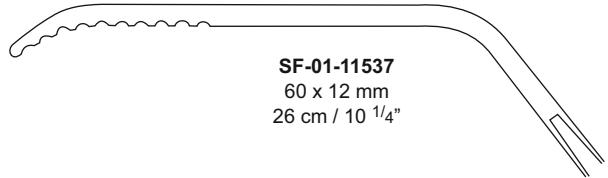

SF-01-11537
60 x 12 mm
26 cm / 10 1/4"

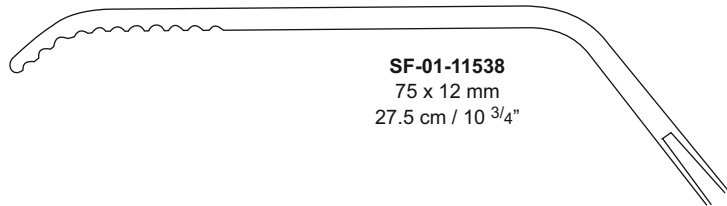

SF-01-11538
75 x 12 mm
27.5 cm / 10 3/4"

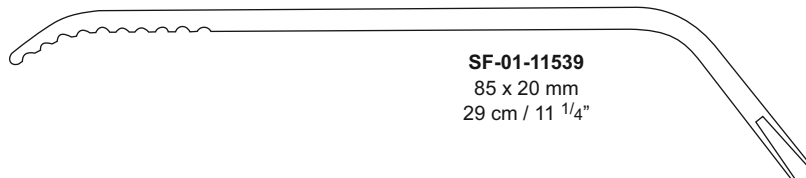

SF-01-11539
85 x 20 mm
29 cm / 11 1/4"

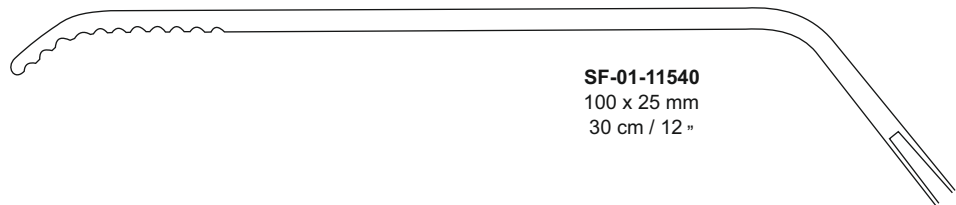

SF-01-11540
100 x 25 mm
30 cm / 12"

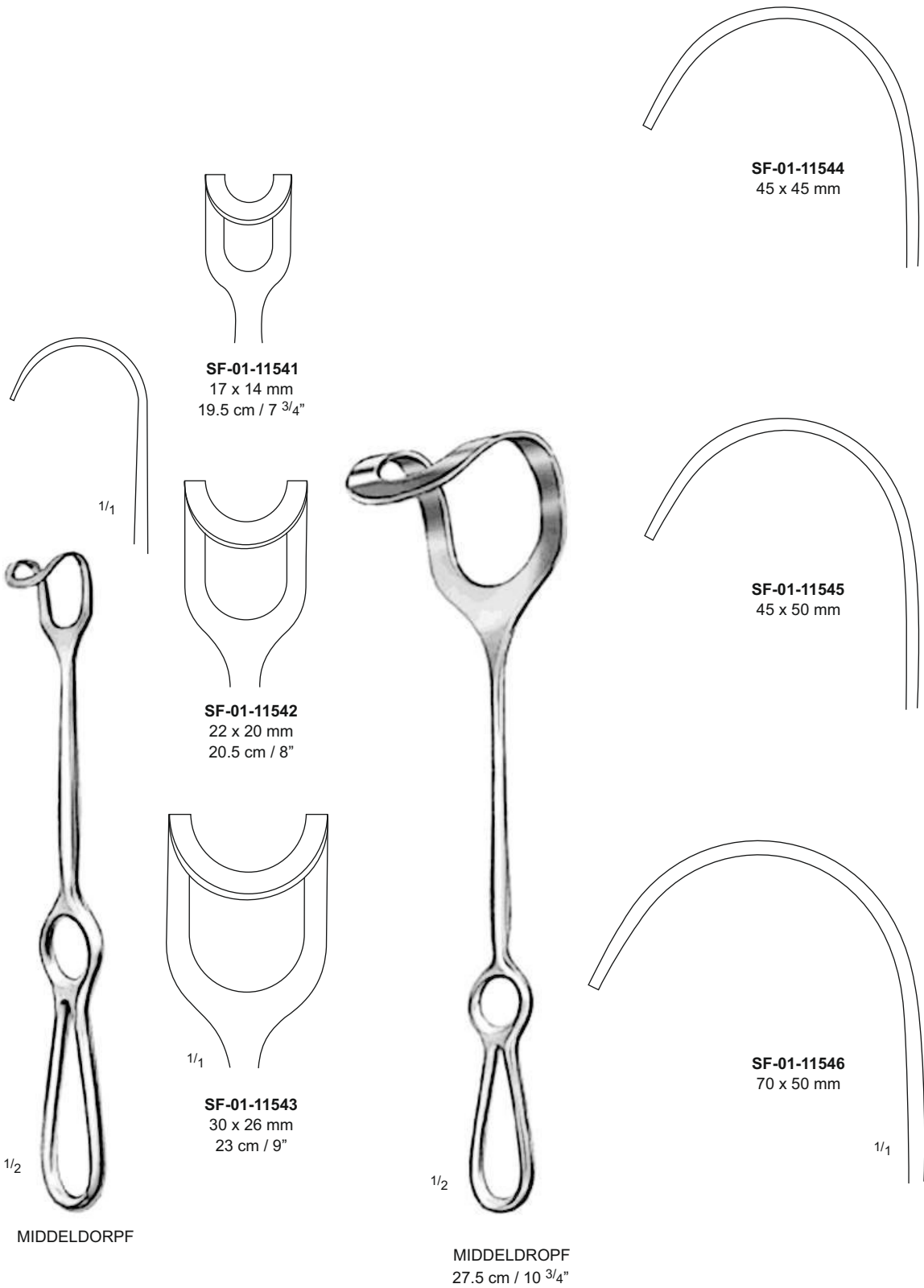

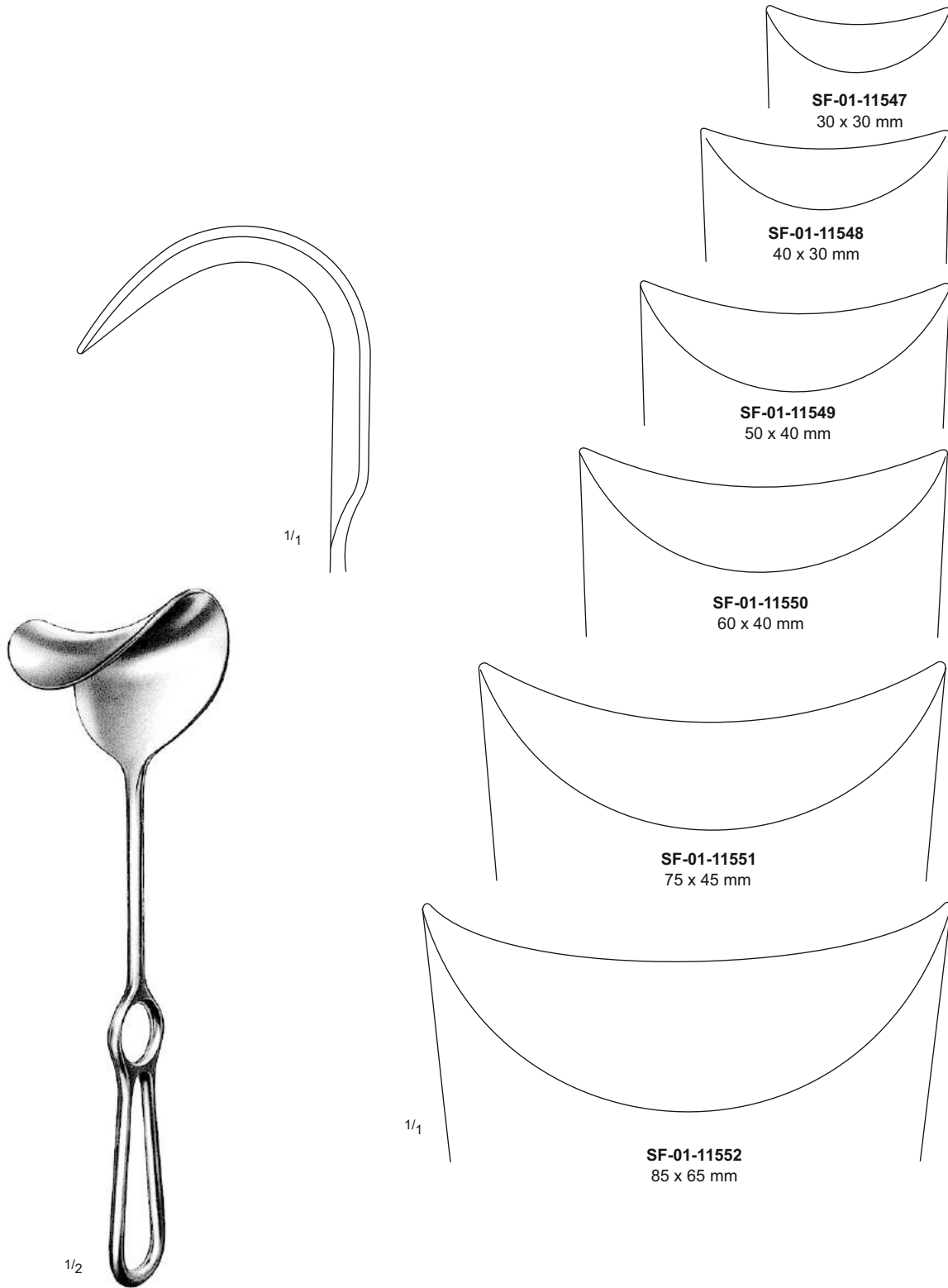

FRITSCH
23 cm / 9"

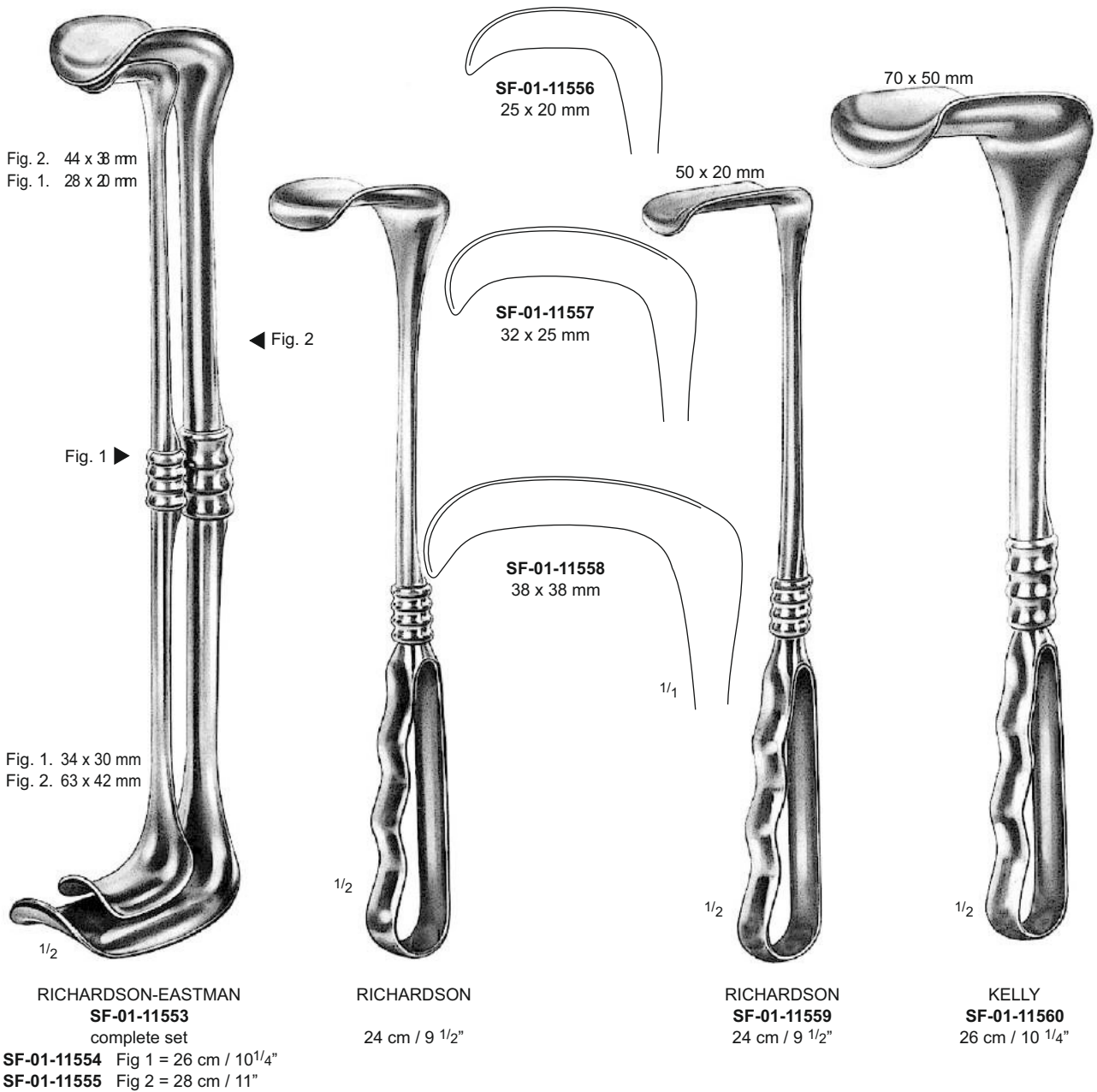

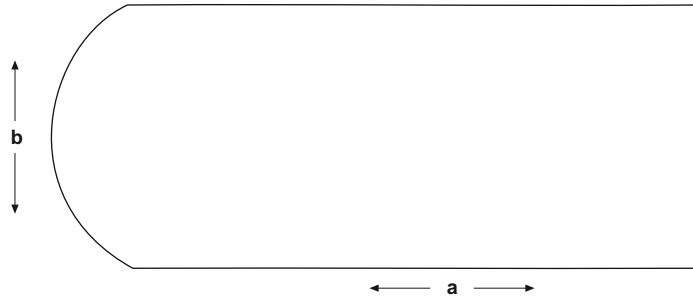

50 x 85 mm

1/2

DOYEN
SF-01-11561
24 cm / 9 1/2"

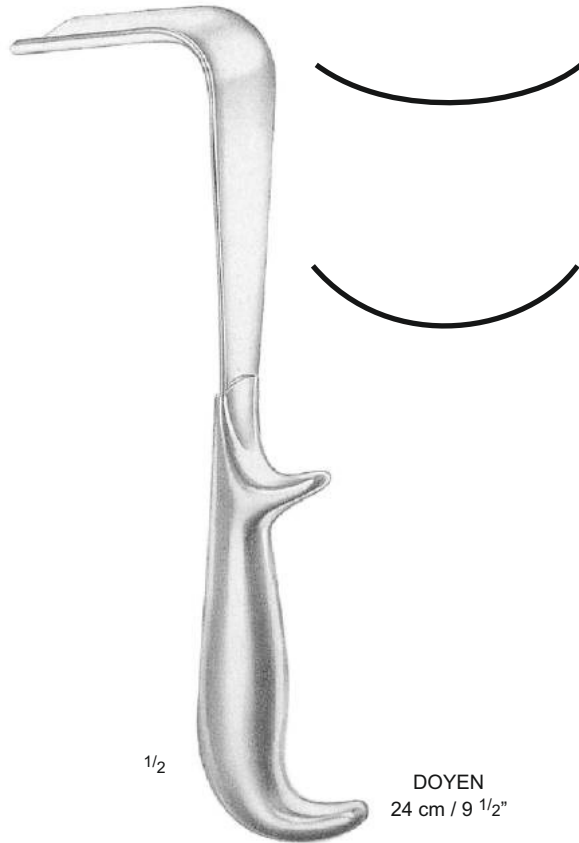

1/2

DOYEN
24 cm / 9 1/2"

a mm	b mm	Slightly Concave	Medium Hollow
55	35	SF-01-11562	SF-01-11573
85	35	SF-01-11563	SF-01-11574
115	35	SF-01-11564	SF-01-11575
55	45	SF-01-11565	SF-01-11576
85	45	SF-01-11566	SF-01-11577
115	45	SF-01-11567	SF-01-11578
160	45	SF-01-11568	SF-01-11579
55	60	SF-01-11560	SF-01-11580
85	60	SF-01-11570	SF-01-11581
115	60	SF-01-11571	SF-01-11582
160	60	SF-01-11572	SF-01-11583

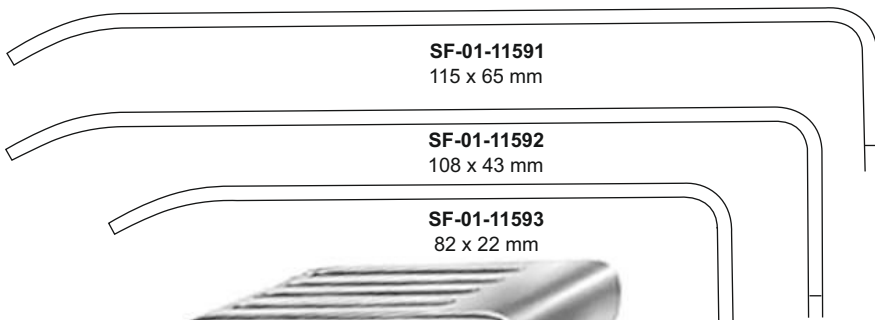
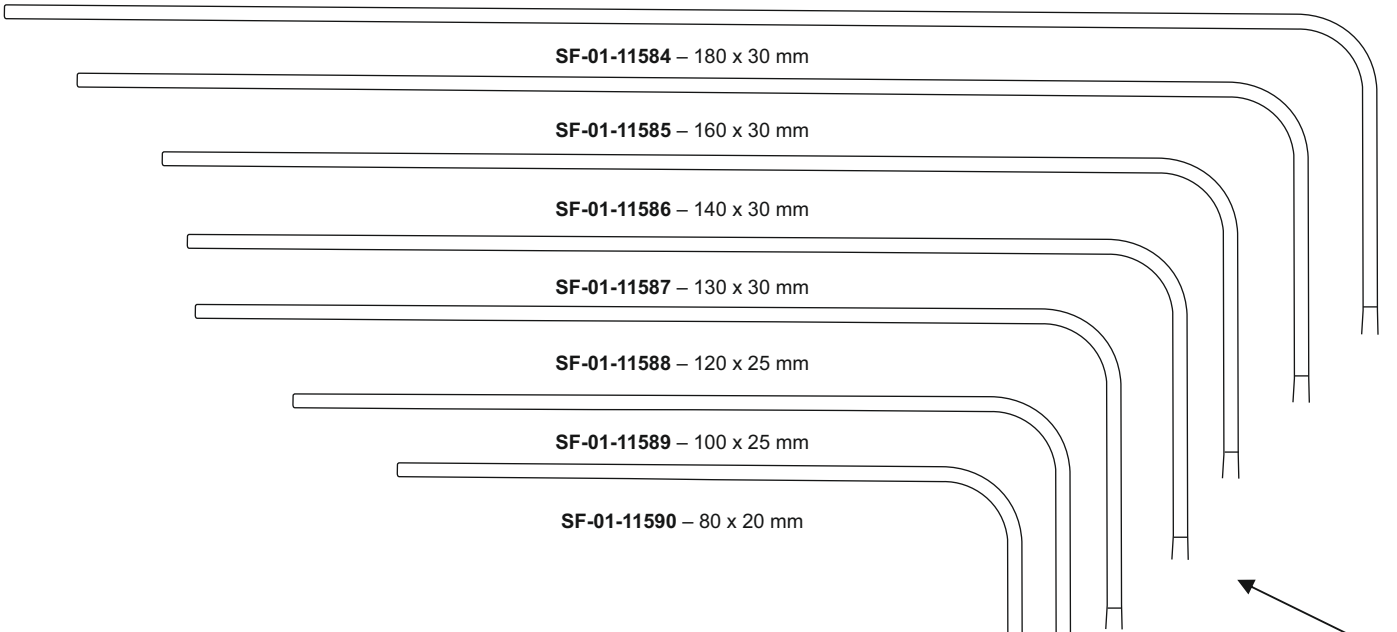

CORYLLOS
24 cm / 9 1/2"

1/2



BRUNNER
25 cm / 10"

1/2

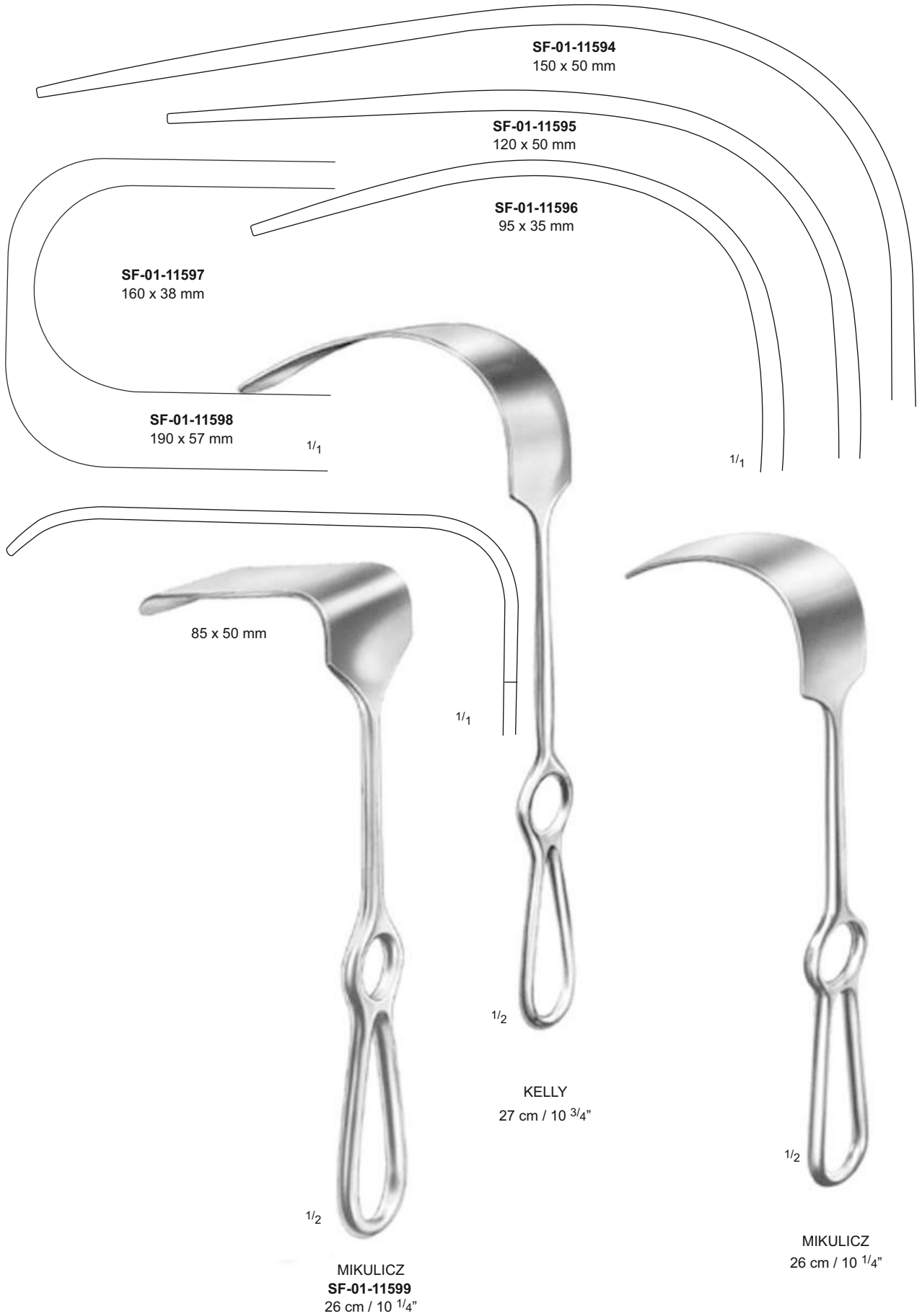

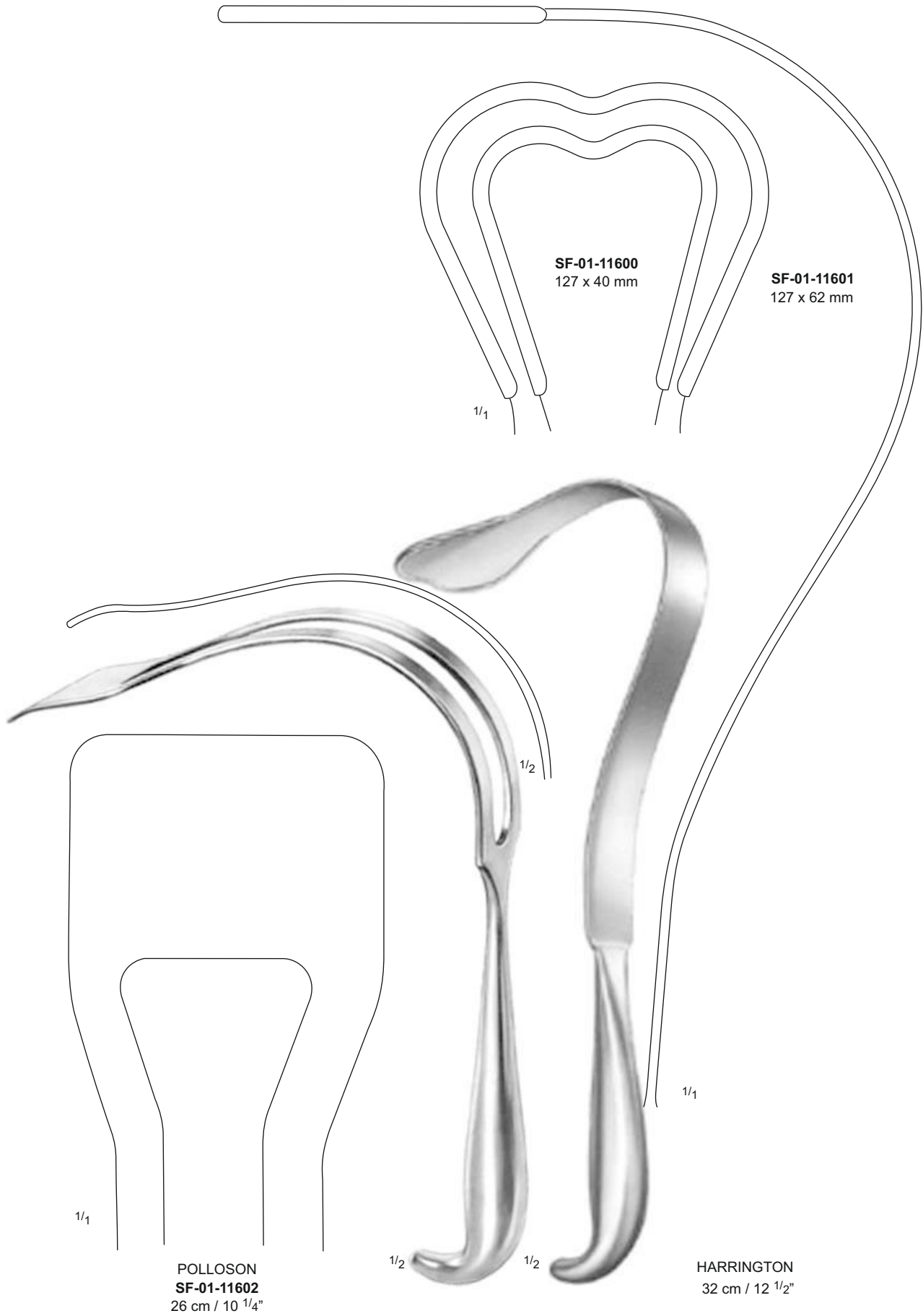





SF-01-11609
30 cm / 12"

SF-01-11610
30 cm / 12"

SF-01-11611 – 75 mm
30 cm / 12"

SF-01-11612 – 100 mm
30 cm / 12"

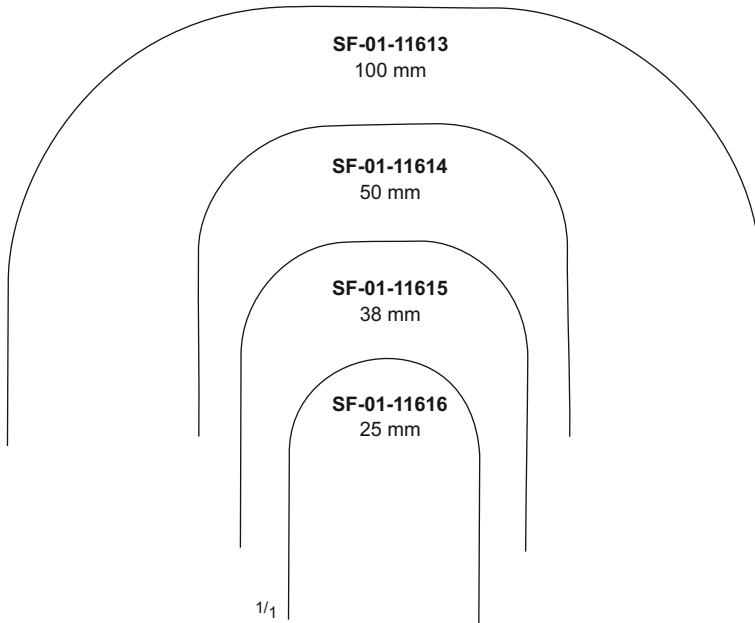

DEAVER
32 cm / 12 1/2"

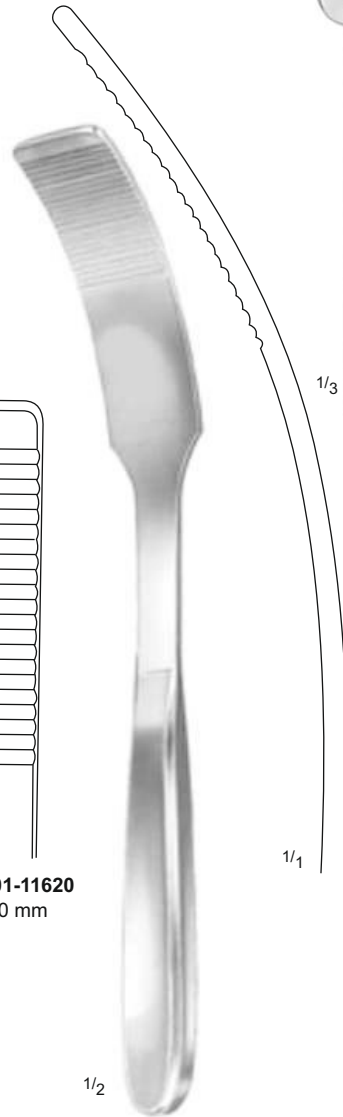
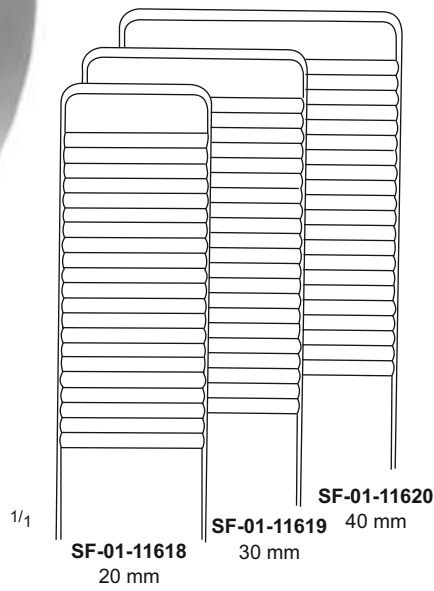

KOERTE
SF-01-11617
30 cm / 12"

KADER
27 cm / 10 3/4"



JANSEN
SF-01-11621
10 cm / 4"
3 x 3 teeth

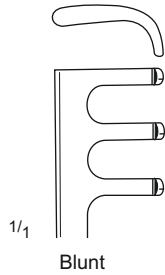

Blunt



ALM
4 X 4 teeth

SF-01-11622
7 cm / 2 3/4"
Sharp

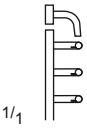
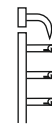

SF-01-11624
7 cm / 2 3/4"
Blunt

SF-01-11623
10 cm / 4"
Sharp

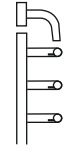
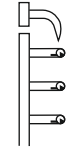

SF-01-11625
10 cm / 4"
Blunt

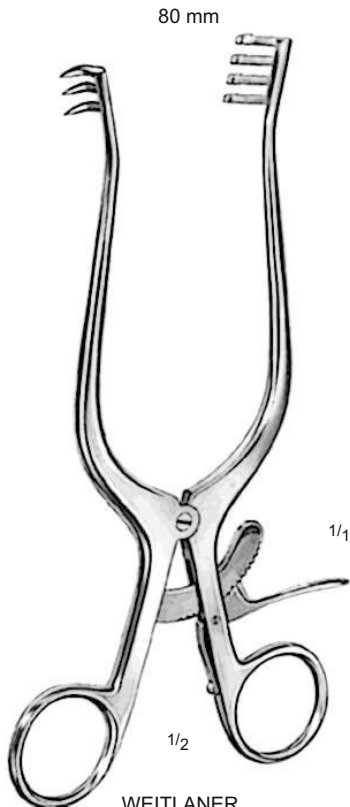

WEITLANER
20 cm / 8"
3 x 4 teeth

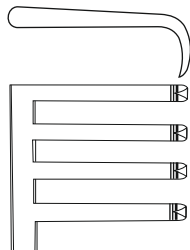

SF-01-11626
Sharp

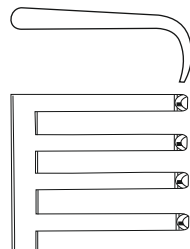

SF-01-11629
Blunt

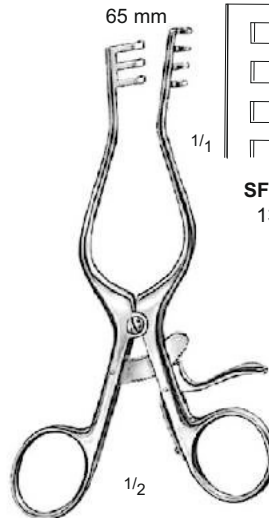

WEITLANER
3 x 4 teeth

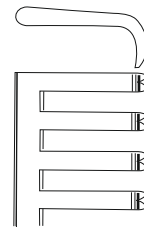

SF-01-11627
13 cm / 5"
Sharp

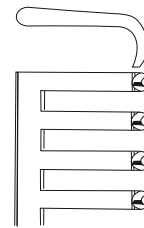

SF-01-11630
13 cm / 5"
Blunt

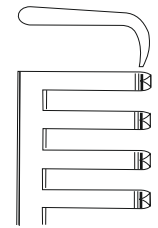

SF-01-11628
16.5 cm / 6 1/2"
Sharp

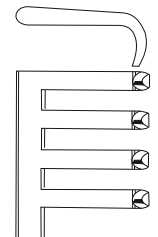

SF-01-11631
16.5 cm / 6 1/2"
Blunt

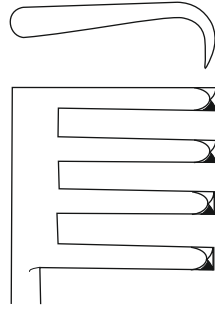

SF-01-11632
Sharp
3 x 4 teeth

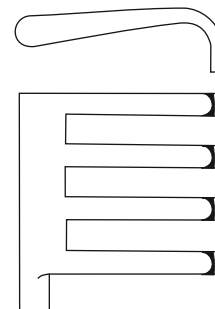

SF-01-11633
Blunt
3 x 4 teeth



ADSON
26.5 cm / 10 1/2"

1/1

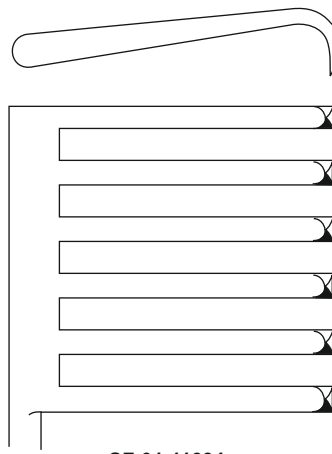

SF-01-11634
Sharp
6 x 6 teeth

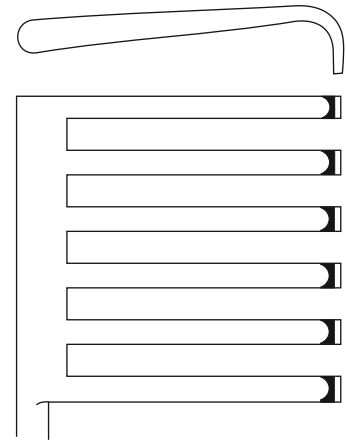

SF-01-11635
Blunt
6 x 6 teeth

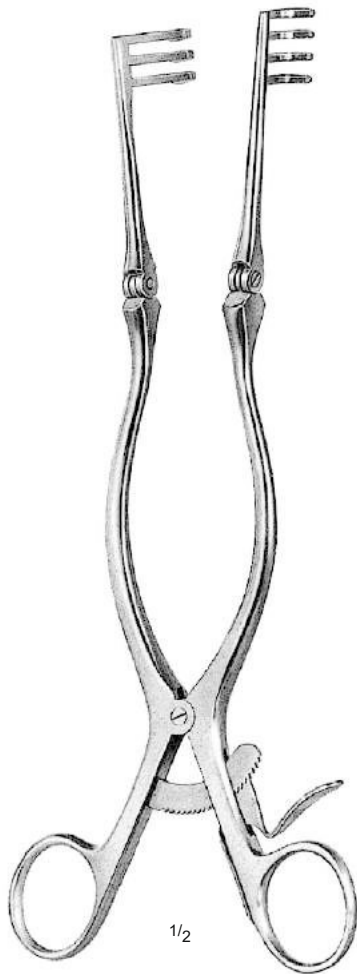

ADSON
3 x 4 teeth

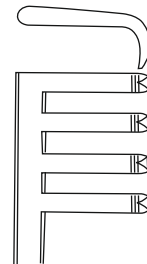

SF-01-11636
13 cm / 5"

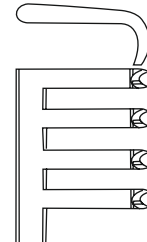

SF-01-11637
13 cm / 5"

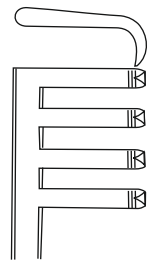

SF-01-11638
16 cm / 6 1/4"

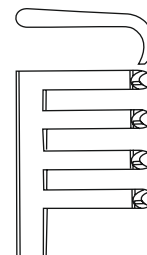

SF-01-11639
16 cm / 6 1/4"

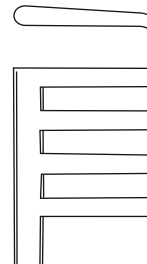

SF-01-11640
20 cm / 8"

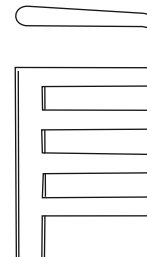

SF-01-11641
20 cm / 8"

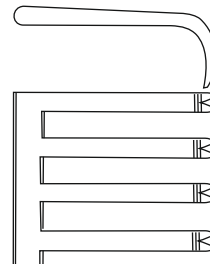

1/1

SF-01-11642
26 cm / 10 1/4"

Sharp

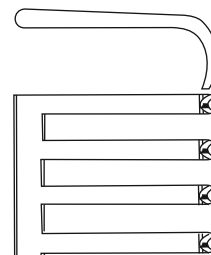

SF-01-11643
26 cm / 10 1/4"

Blunt

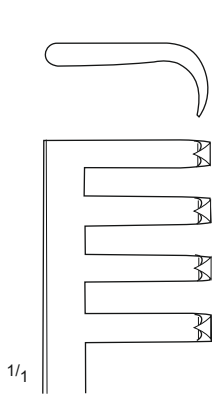

Sharp

150

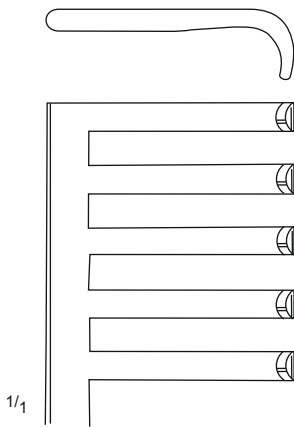

Blunt

150 mm

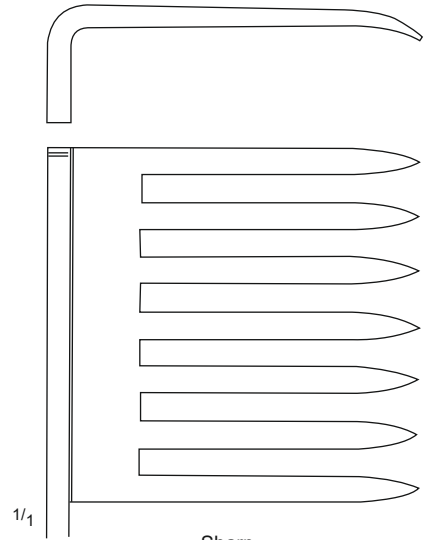

Sharp



BECKMANN
SF-01-11644
31 cm / 12 1/4"
4 x 4 teeth

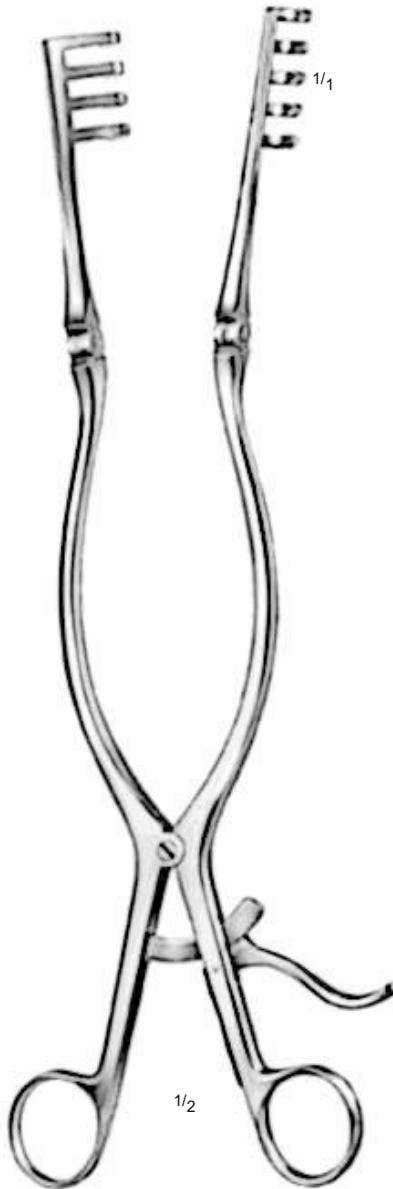

ADSON
SF-01-11645
32 cm / 12 1/2"
4 x 5 teeth

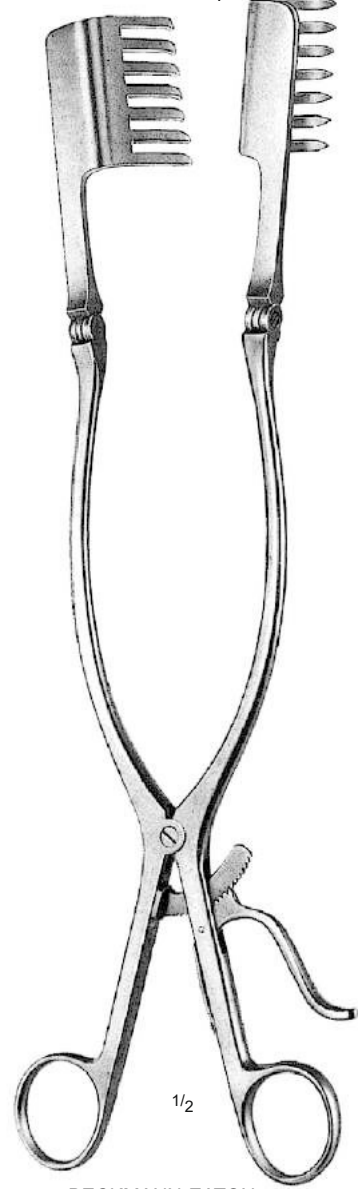

BECKMANN-EATON
SF-01-11646
32 cm / 12 1/2"
7 x 7 teeth



BECKMANN-ADSON
31 cm / 12 1/4"
4 x 4 teeth

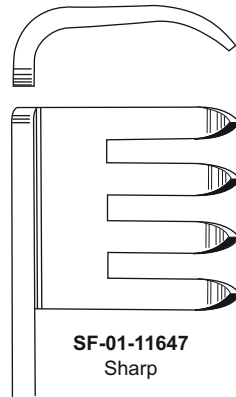

SF-01-11647
Sharp

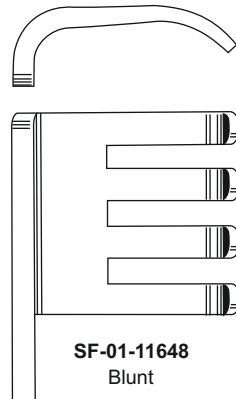

SF-01-11648
Blunt

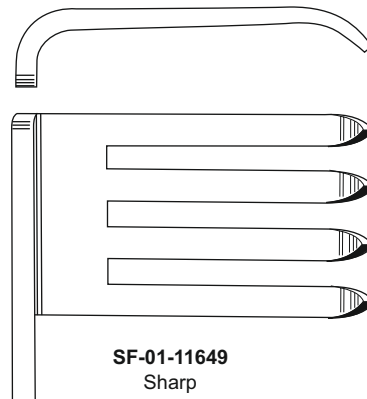

SF-01-11649
Sharp

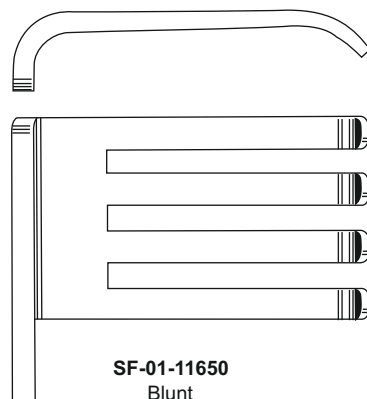

SF-01-11650
Blunt

1/1

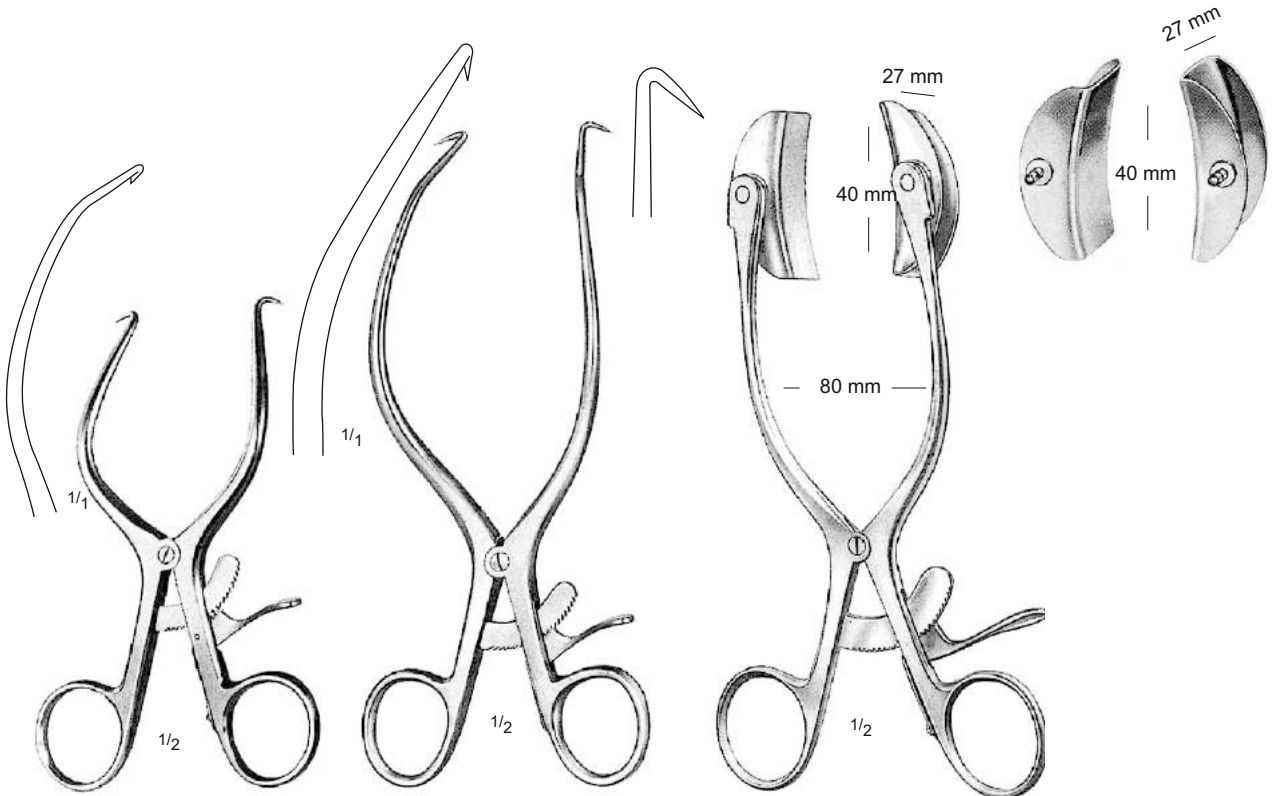

GELPI
SF-01-11651
14 cm / 5 1/2"

GELPI
SF-01-11652
17 cm / 6 3/4"

COLLIN BABY
SF-01-11653
complete with two pair of blades

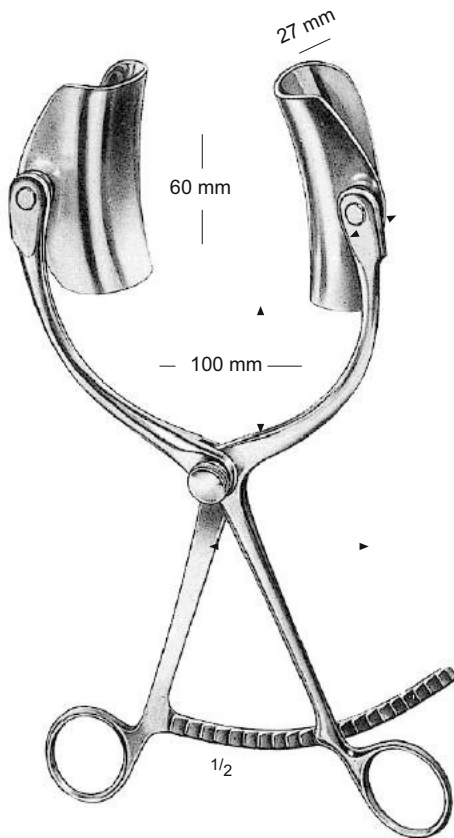

COLLIN
SF-01-11654
24 cm / 9 1/2"



COLLIN
Lateral Blades Centre Blades
SF-01-11655 = 38 x 60 mm— 38 x 55 mm
SF-01-11656 = 38 x 80 mm— 50 x 75 mm

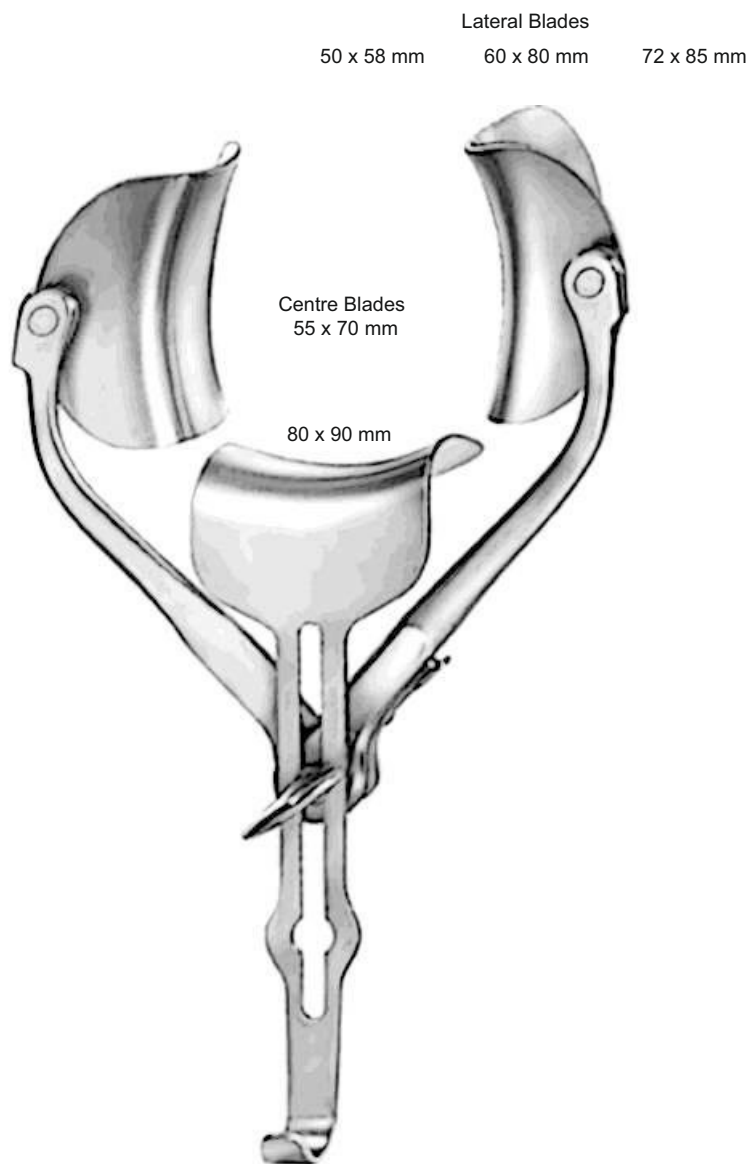

RICARD
SF-01-11657 -28 cm / 11"
SF-01-11658 -30 cm / 12"
complete

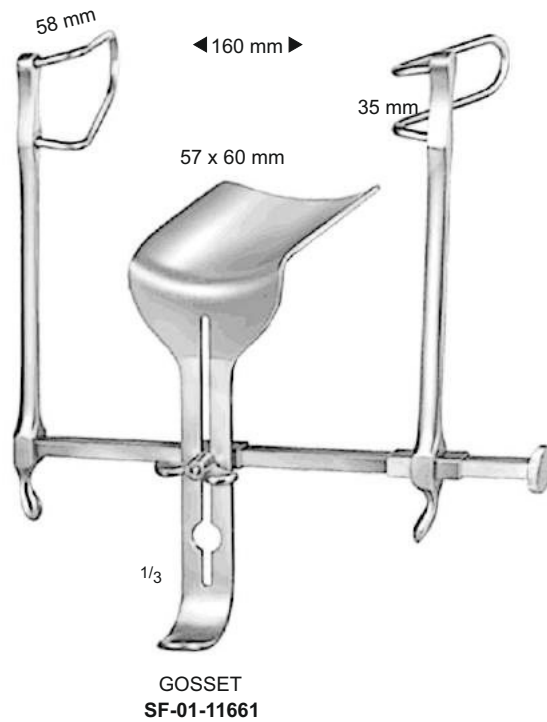
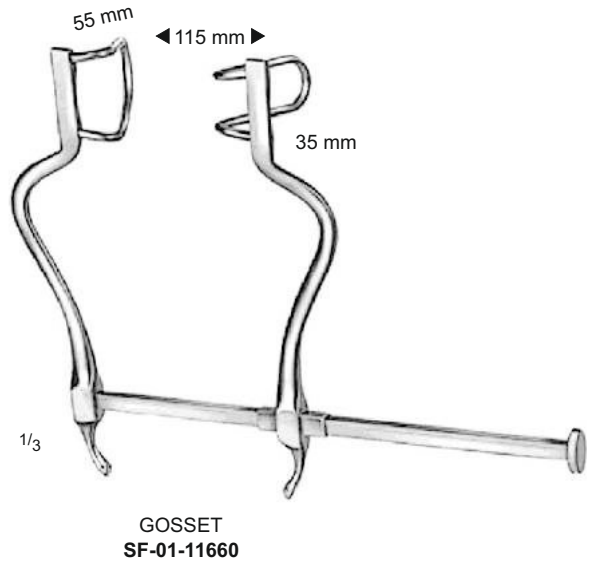
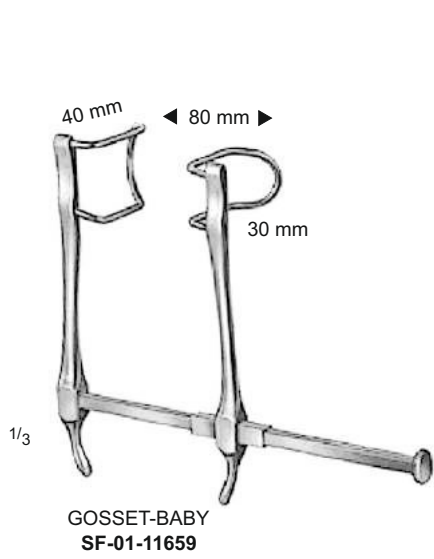

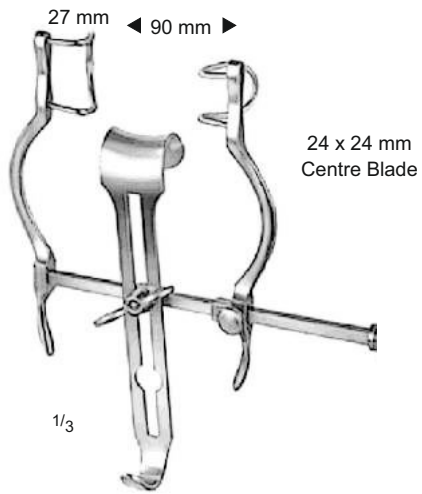

BALFOUR BABY
SF-01-11662

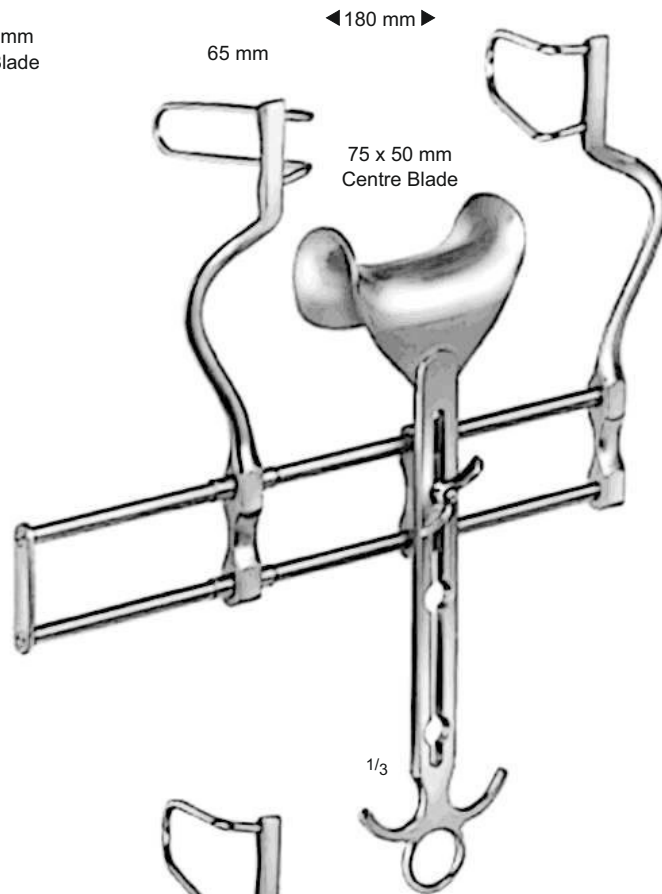

BALFOUR
SF-01-11663

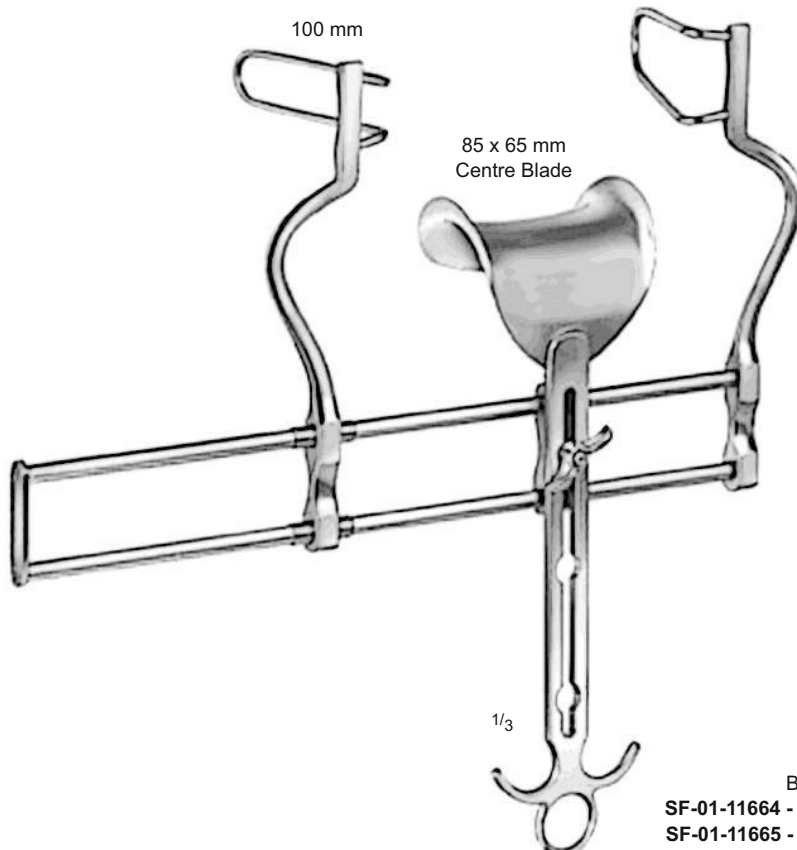

BALFOUR
SF-01-11664 - Maximum Spread 180 mm
SF-01-11665 - Maximum Spread 250 mm

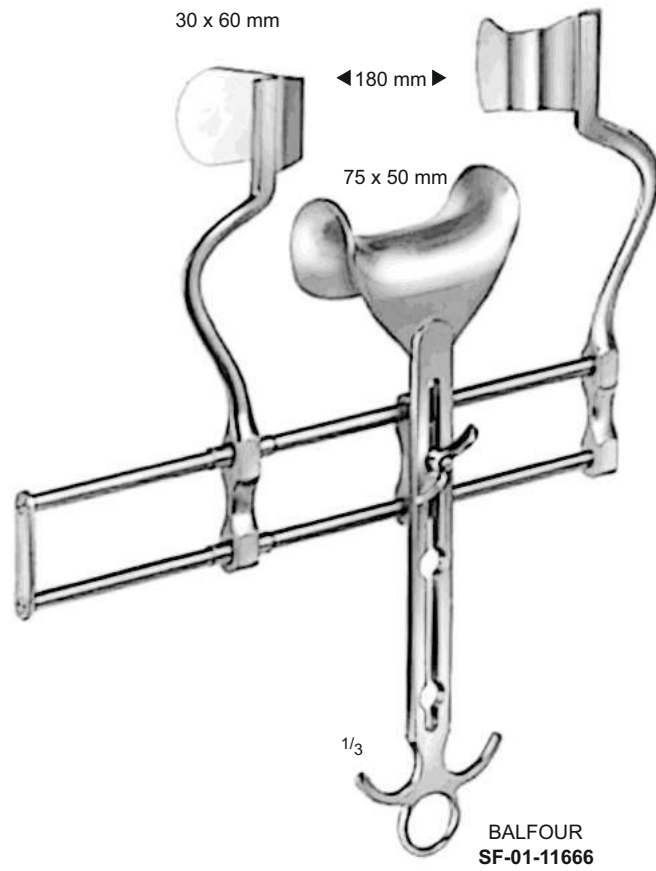

BALFOUR
SF-01-11667 63 x 38 mm
SF-01-11668 75 x 50 mm



SF-01-11669 85 x 65 mm
SF-01-11670 80 x 80 mm



DOYEN
SF-01-11671- 95 x 60 mm
SF-01-11672 - 105 x 65 mm
SF-01-11673 - 115 x 65 mm
SF-01-11674 - 125 x 65 mm

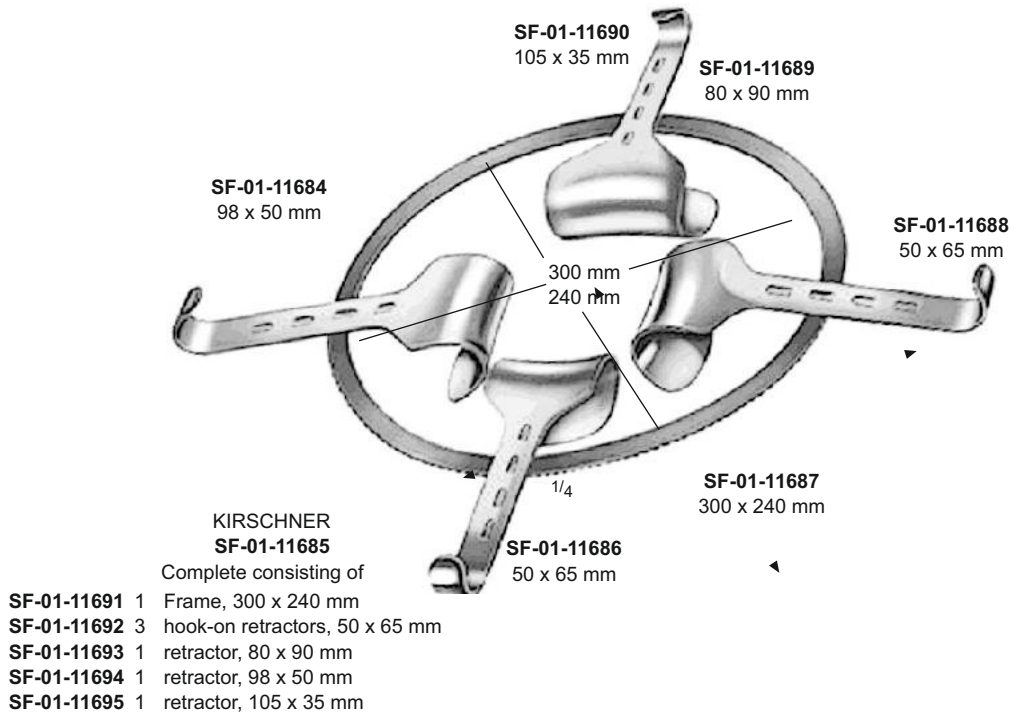
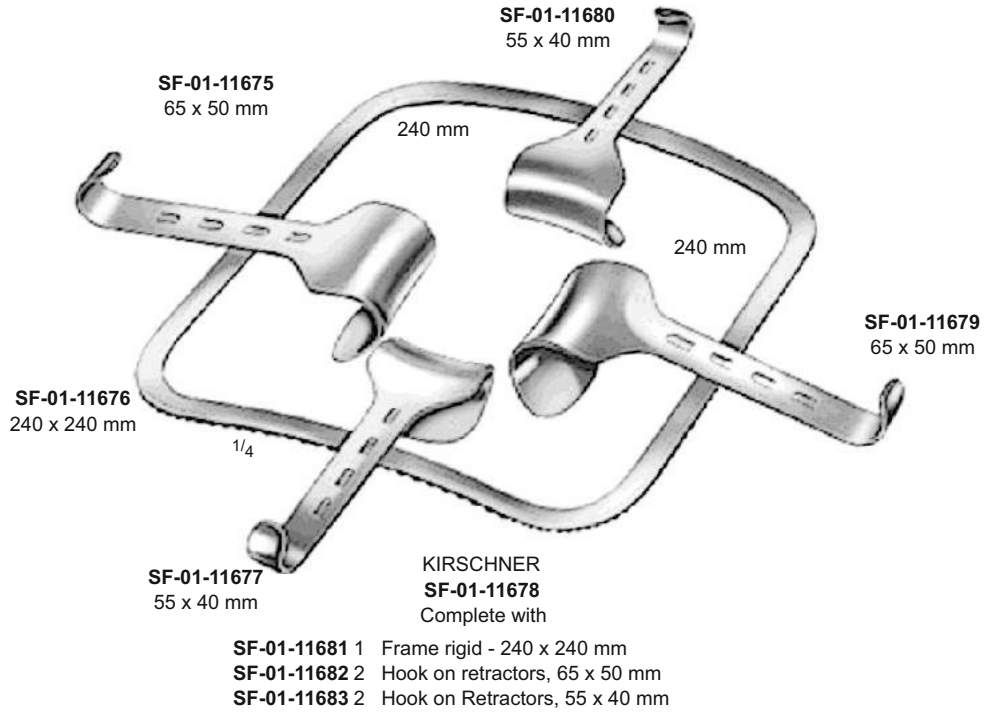

Cardiovascular



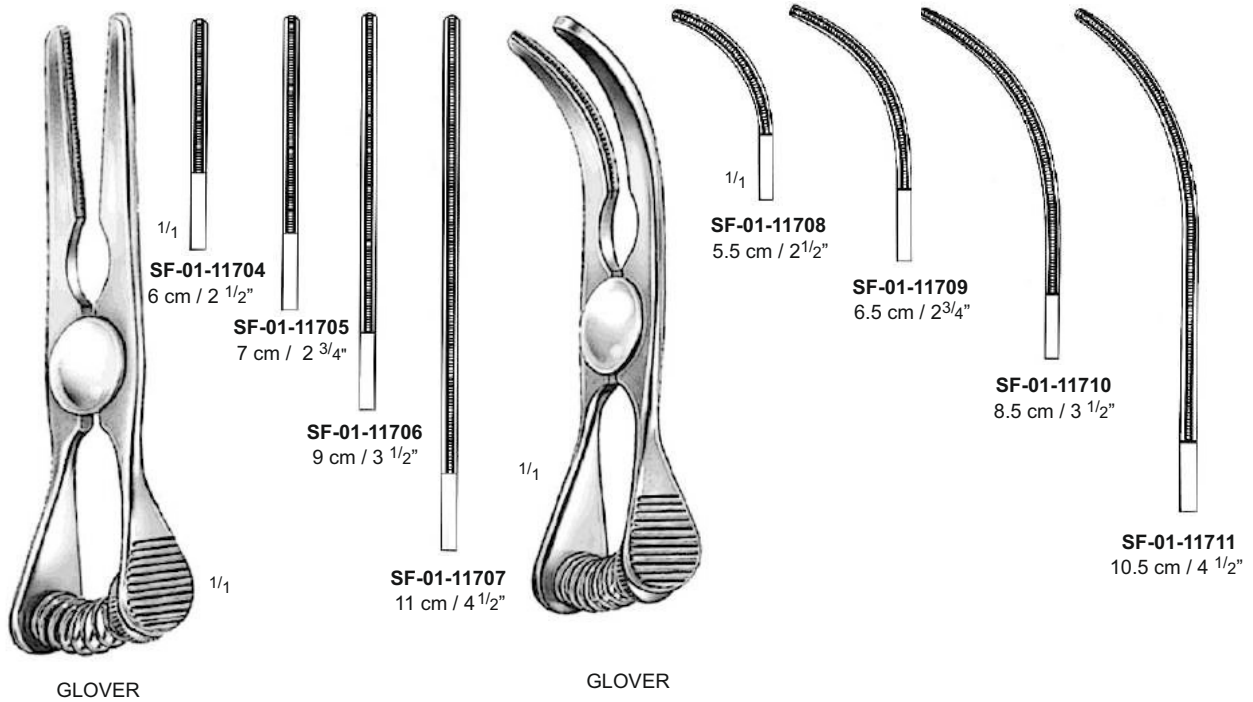
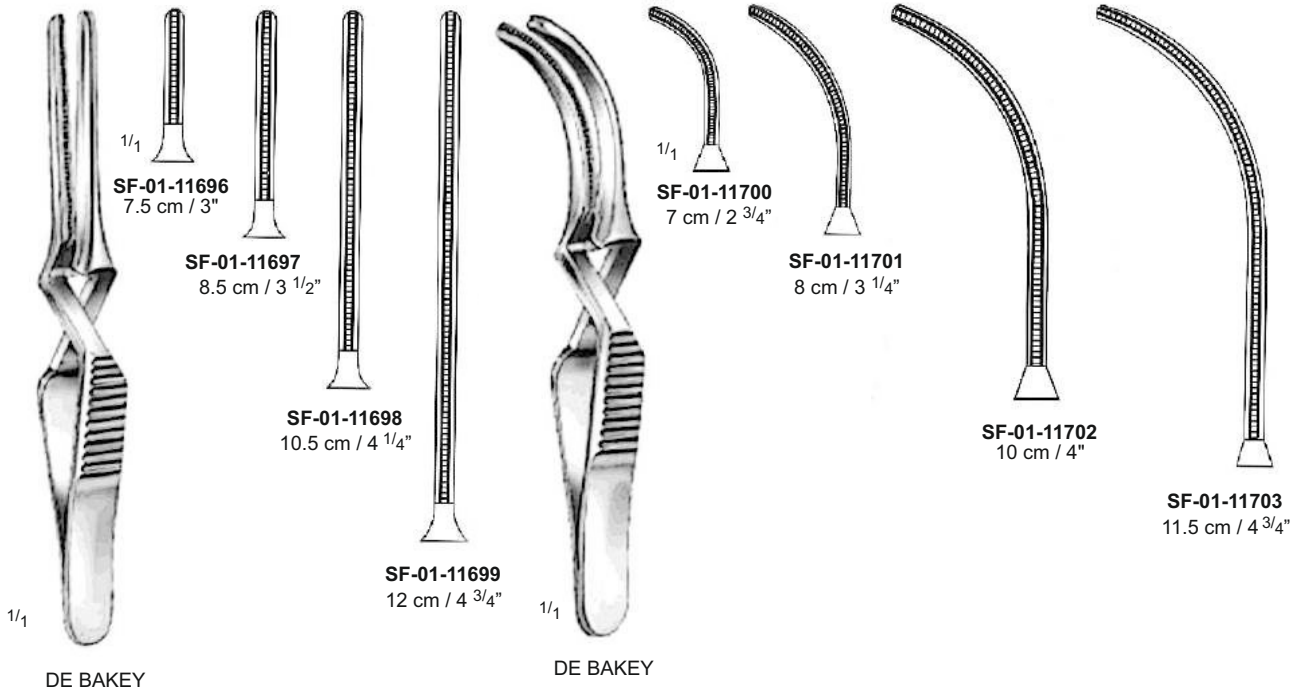

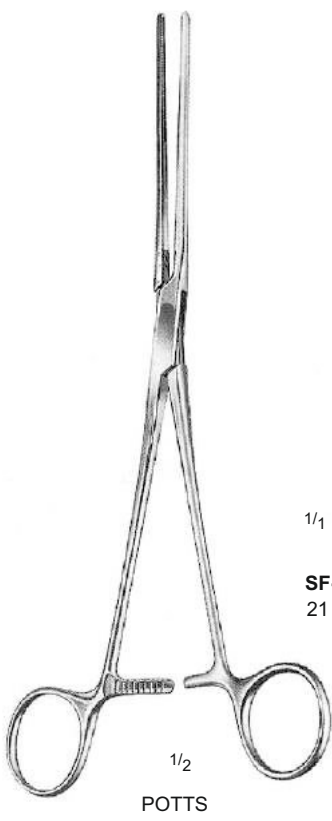

SF-01-11712
21 cm / 8 1/4"

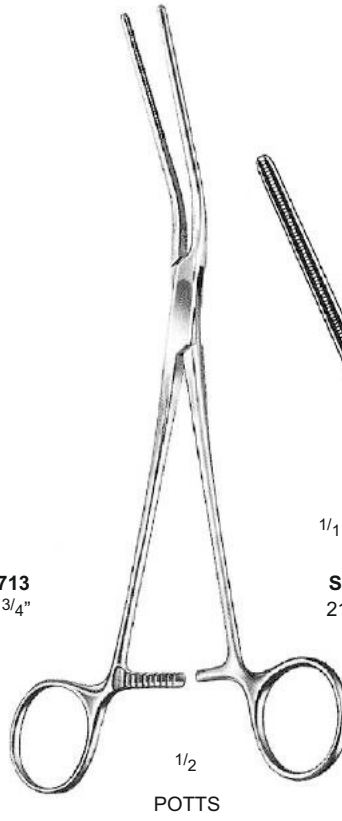

SF-01-11713
22 cm / 8 3/4"

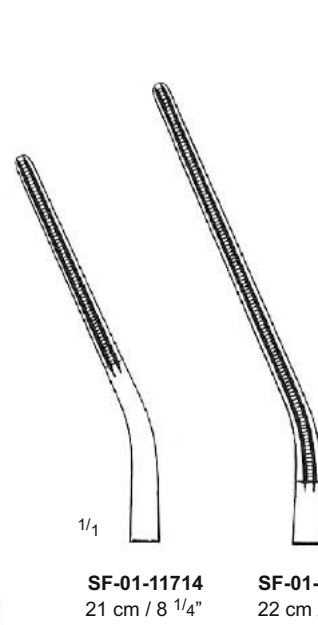

SF-01-11714
21 cm / 8 1/4"

SF-01-11715
22 cm / 8 3/4"

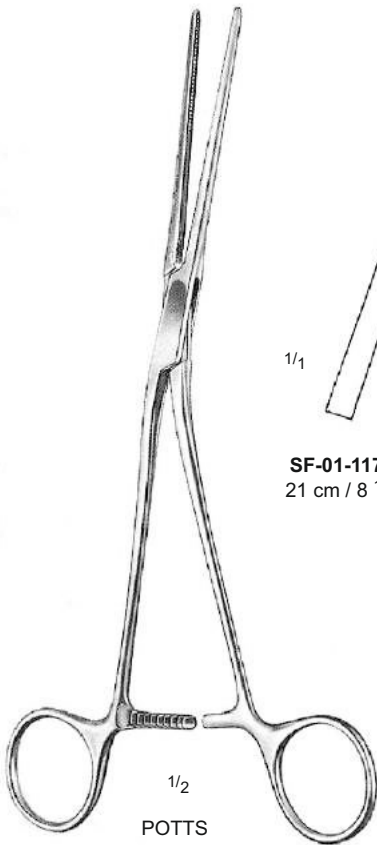

SF-01-11716
21 cm / 8 1/4"



SF-01-11717
22 cm / 8 3/4"

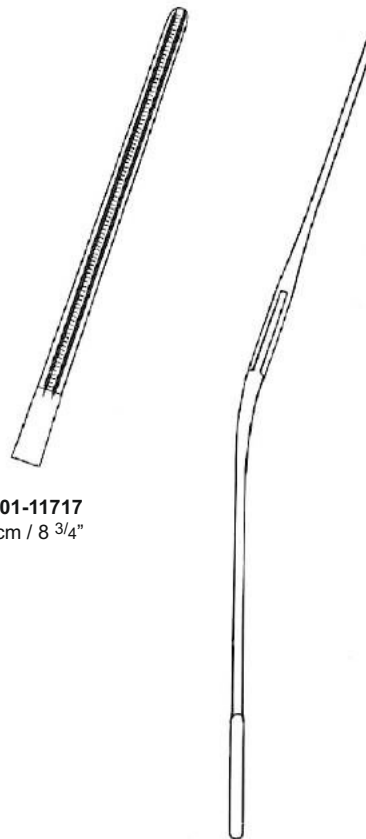

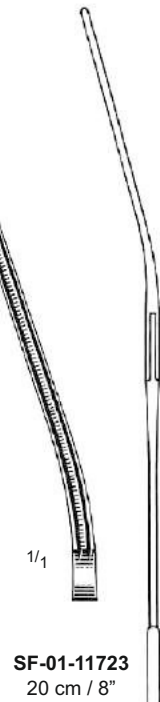
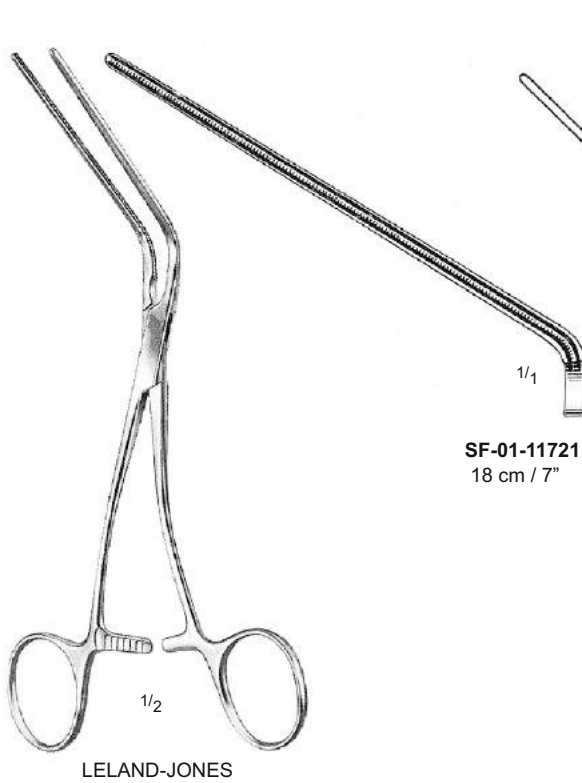
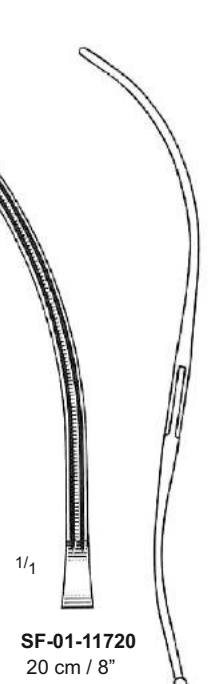
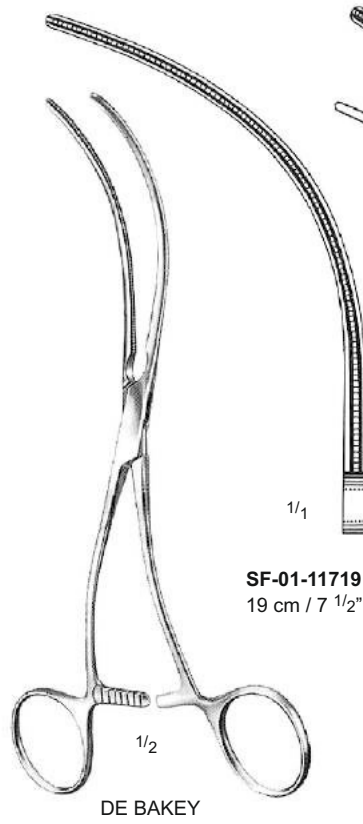
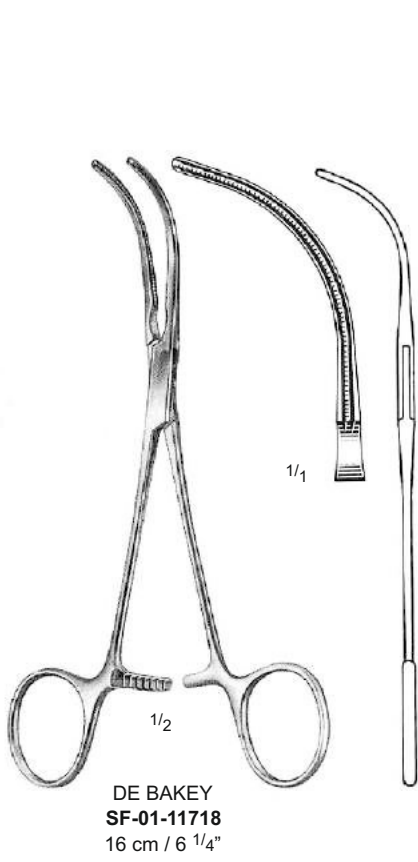

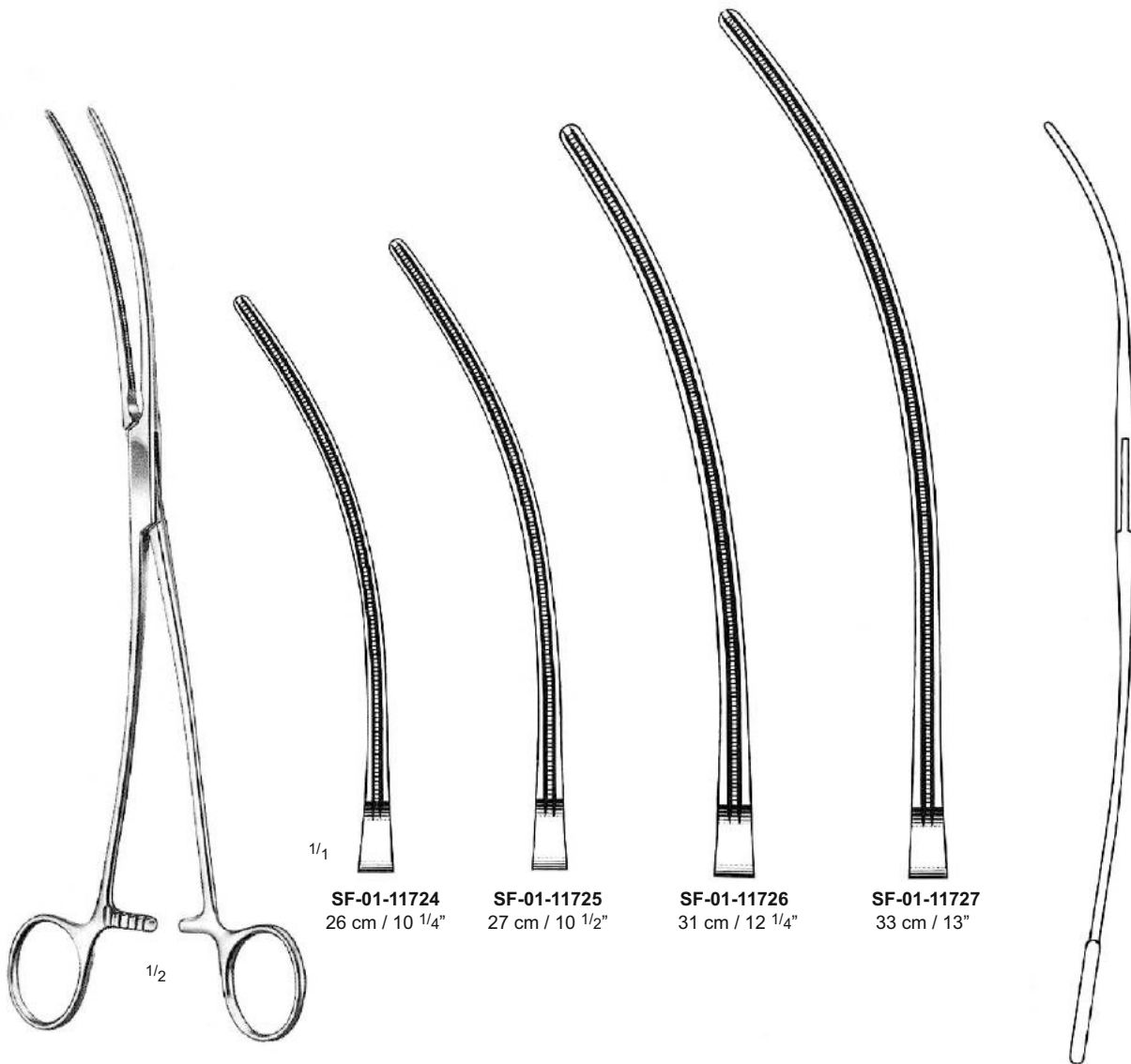

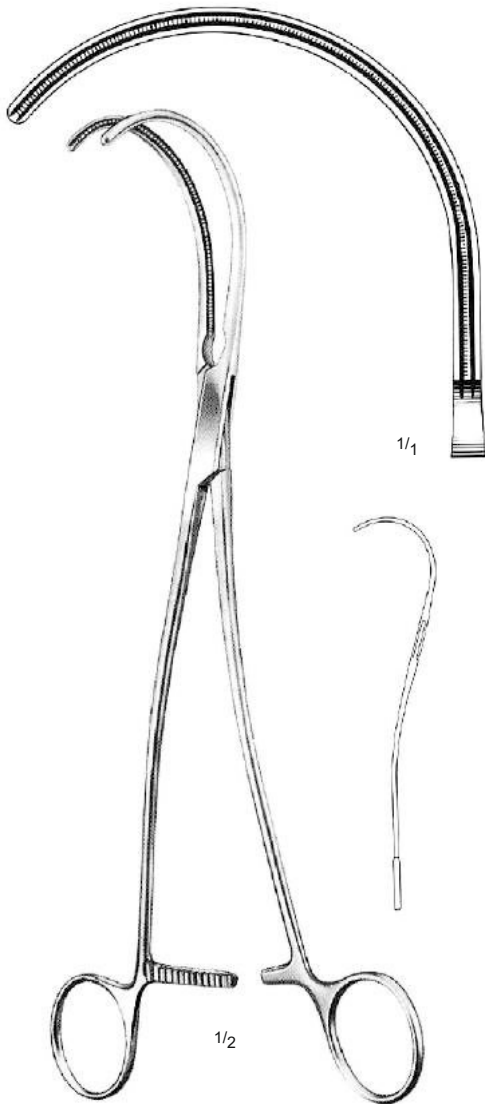

DE BAKEY
SF-01-11728
26 cm / 10 1/4"

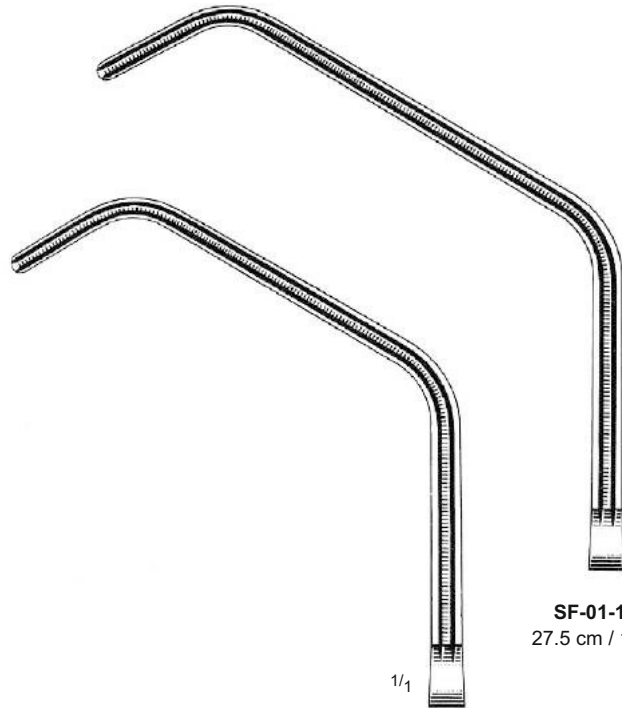

SF-01-11729
26.5 cm / 10 1/2"

SF-01-11730
27.5 cm / 10 3/4"

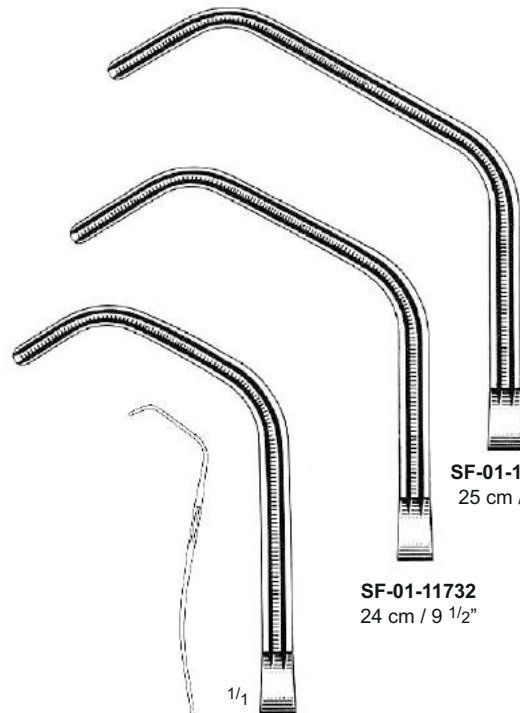

SF-01-11732
24 cm / 9 1/2"

SF-01-11733
25 cm / 10"

SF-01-11731
20.5 cm / 8 1/4"

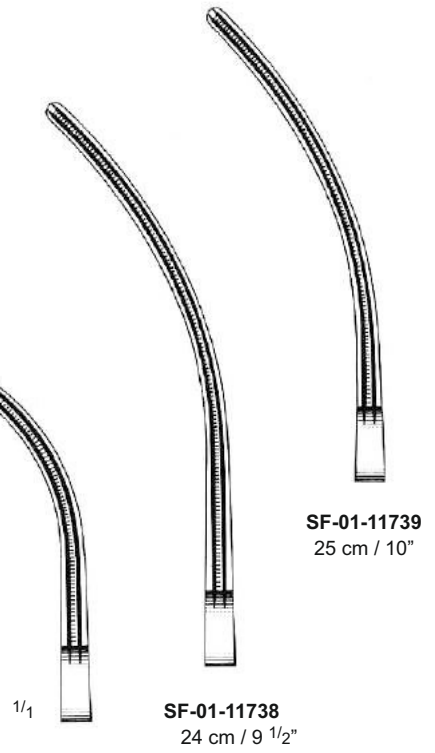
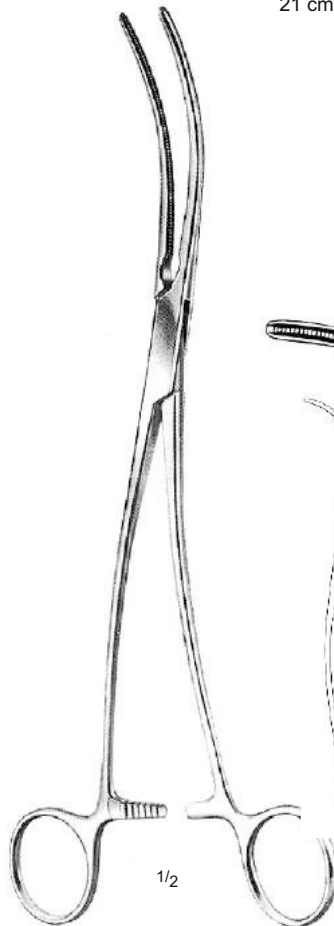
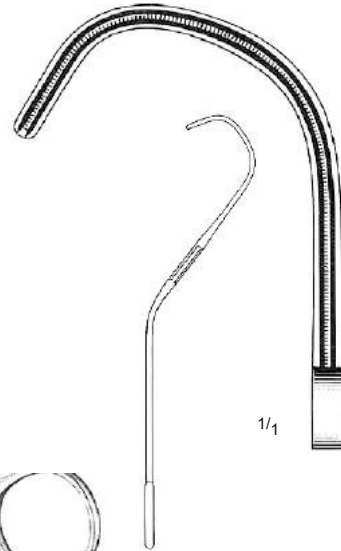
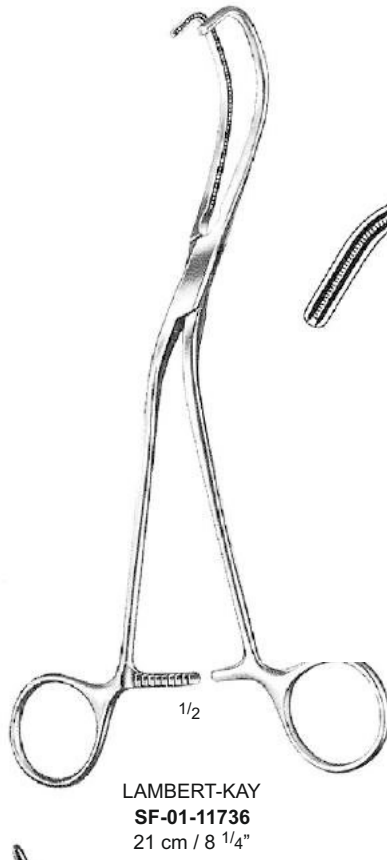
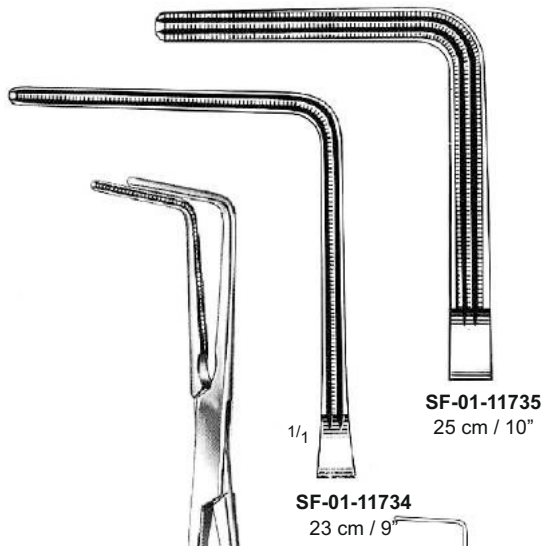

SF-01-11737
23 cm / 9"

DE BAKEY

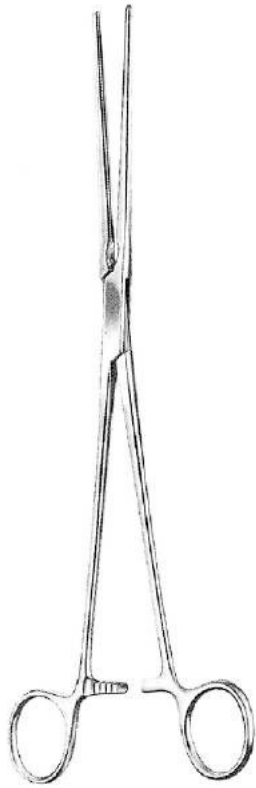

1/1



SF-01-11740
21.5 cm / 8 1/2"



SF-01-11741
23 cm / 9"



SF-01-11742
27 cm / 10 1/2"



SF-01-11743
31.5 cm / 12 1/2"



1/1



SF-01-11744
21.5 cm / 8 1/2"



SF-01-11745
23 cm / 9"

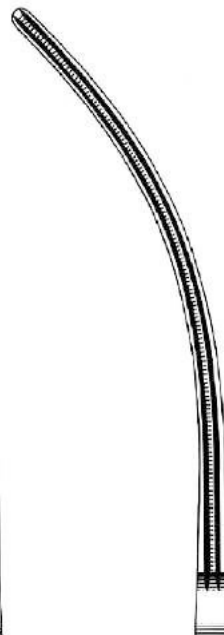

SF-01-11746
27 cm / 10 1/2"



SF-01-11747
31.5 cm / 12 1/2"



DE BAKKEY

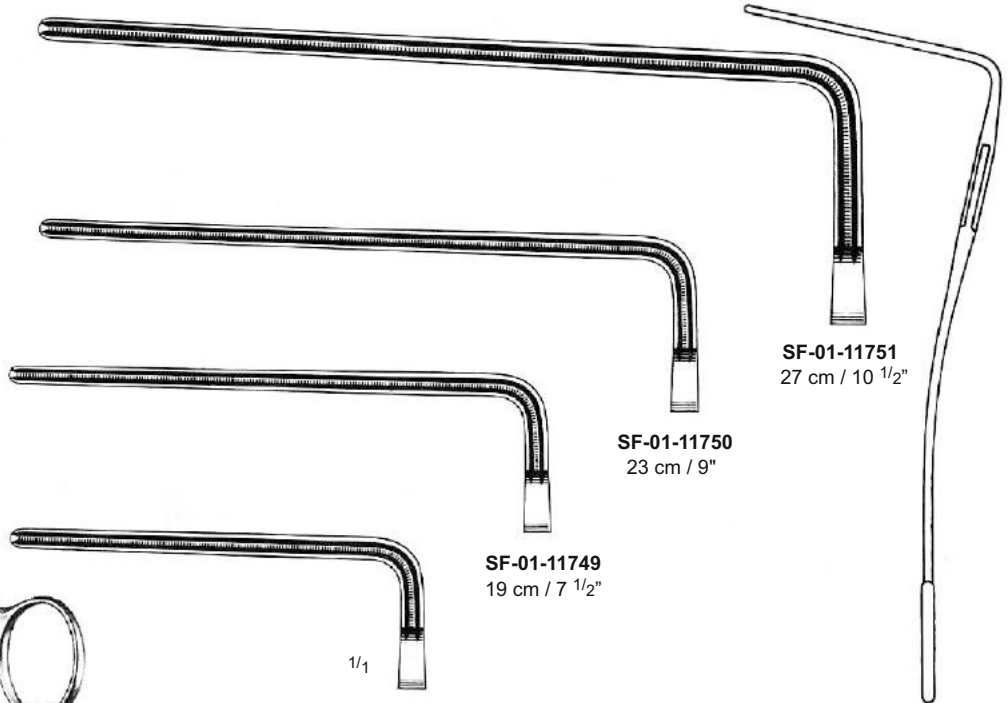

SF-01-11751
27 cm / 10 1/2"

SF-01-11750
23 cm / 9"

SF-01-11749
19 cm / 7 1/2"

1/4

SF-01-11748
18 cm / 7"

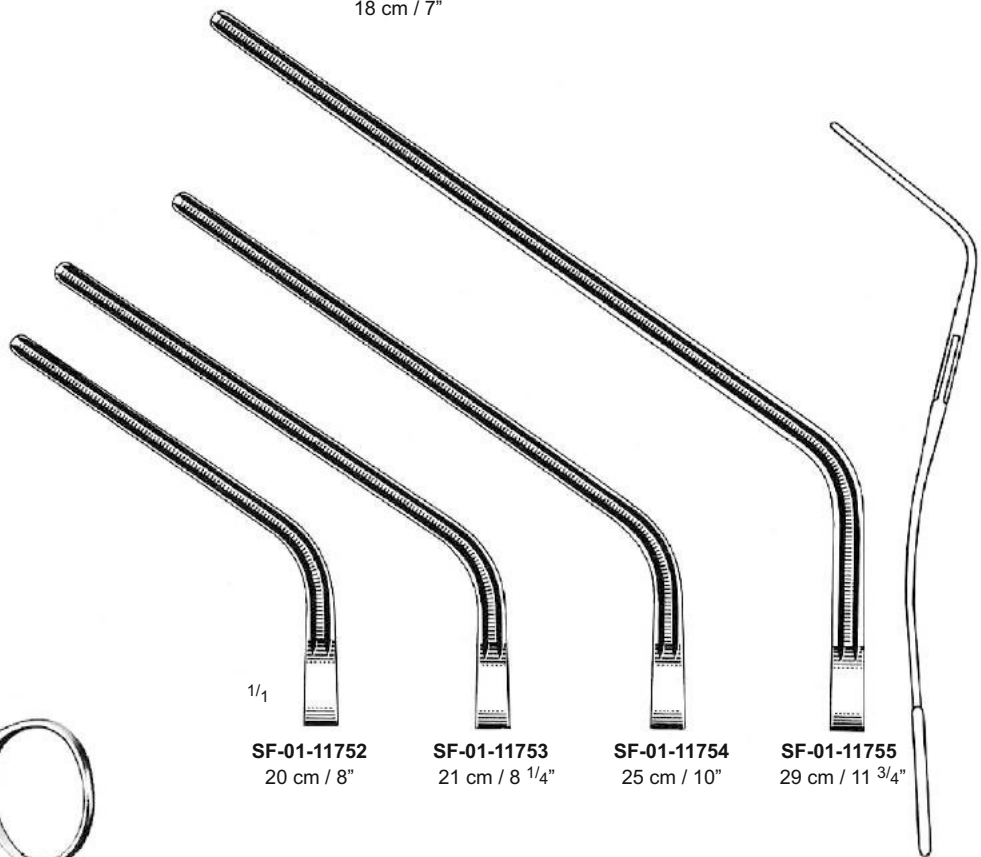
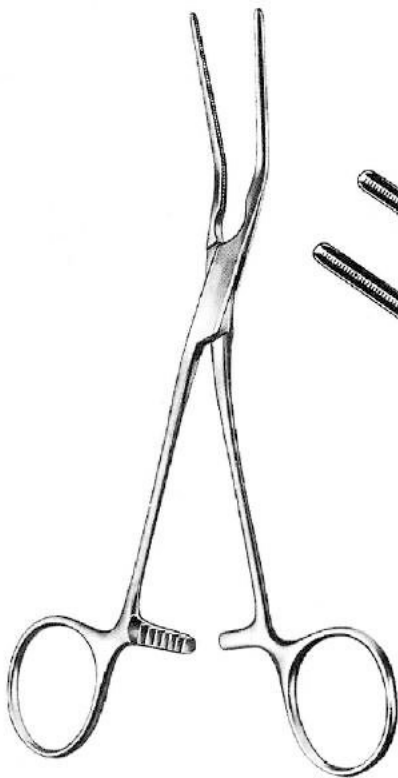

1/4

SF-01-11752
20 cm / 8"

SF-01-11753
21 cm / 8 1/4"

SF-01-11754
25 cm / 10"

SF-01-11755
29 cm / 11 3/4"

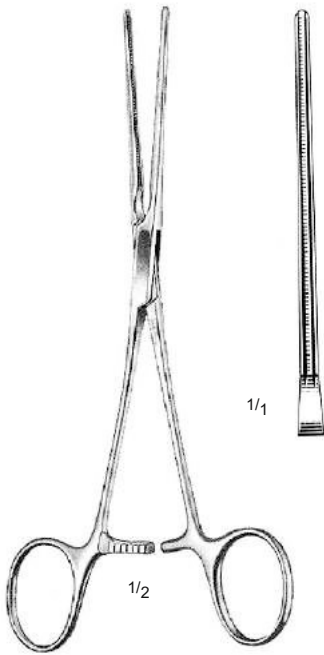

DE BAKEY
SF-01-11756
17 cm / 6 3/4"

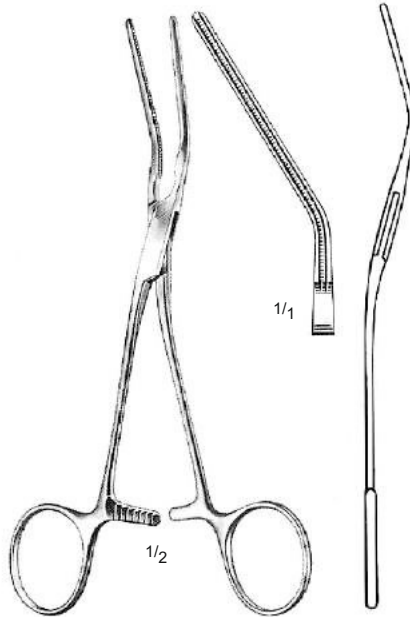

DE BAKEY
SF-01-11757
16 cm / 6 1/4"

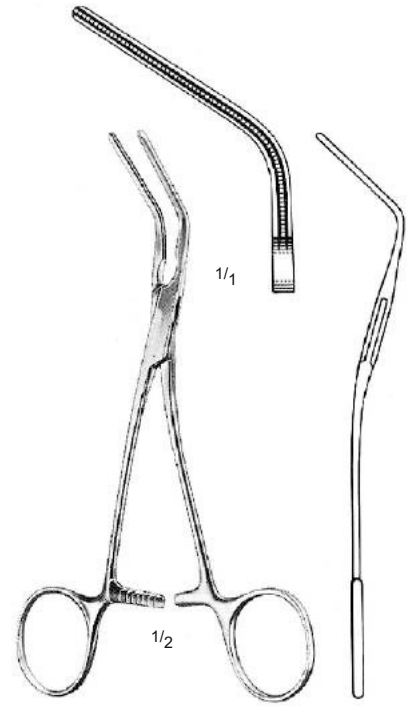

DE BAKEY
SF-01-11758
15 cm / 6"

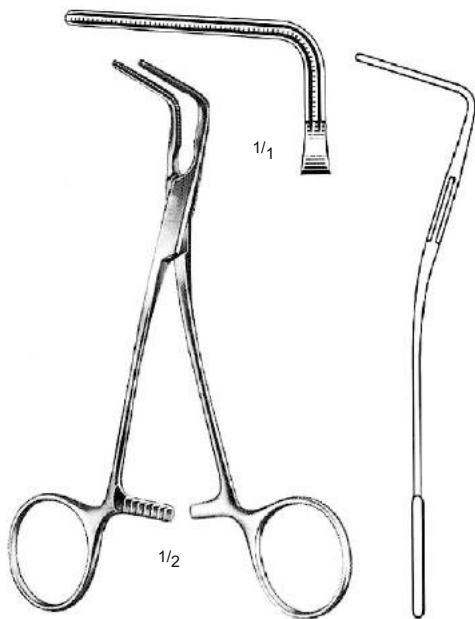

DE BAKEY
SF-01-11759
15 cm / 6"

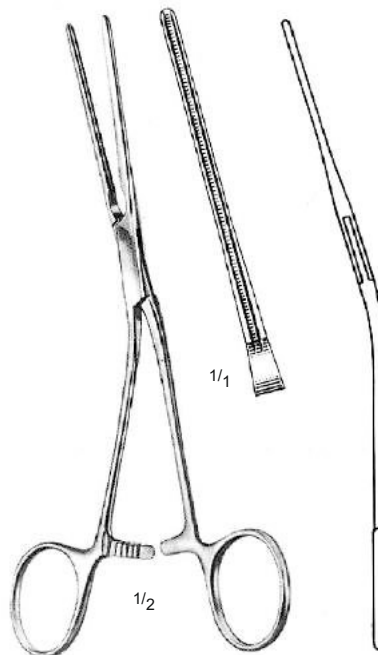

DE BAKEY
SF-01-11760
17 cm / 6 3/4"

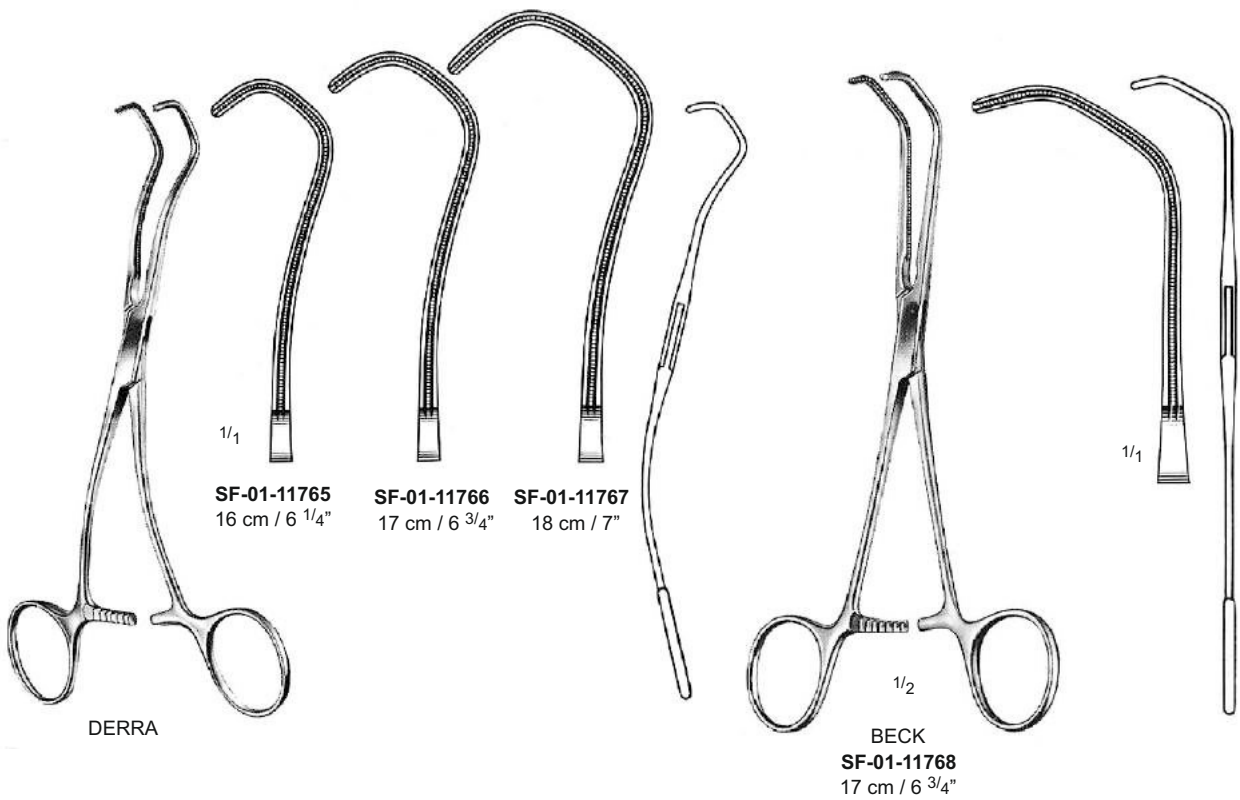
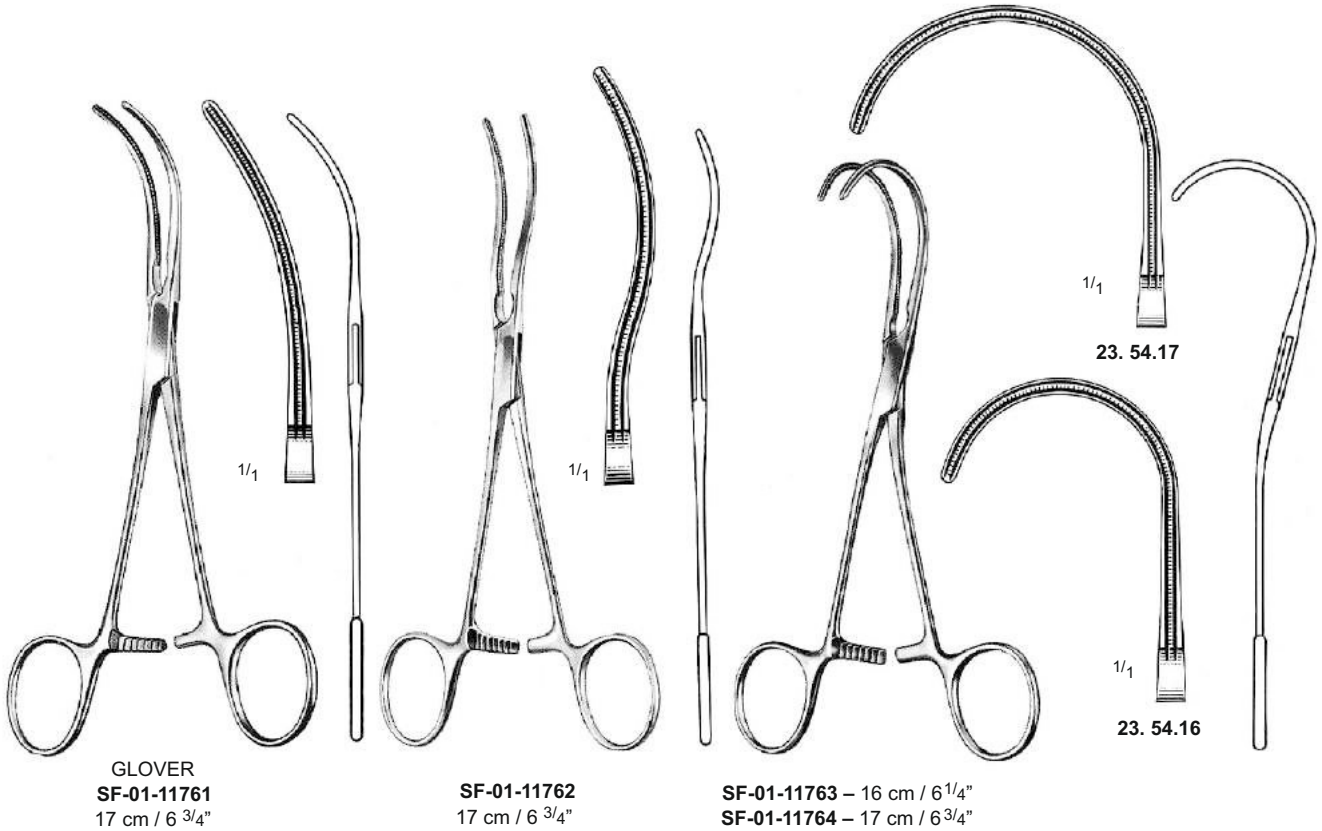

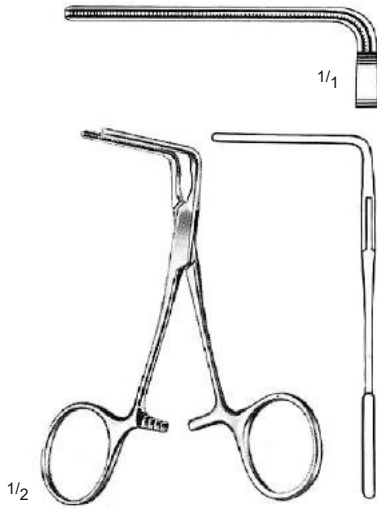

DE BAKEY
SF-01-11769
10 cm / 4"

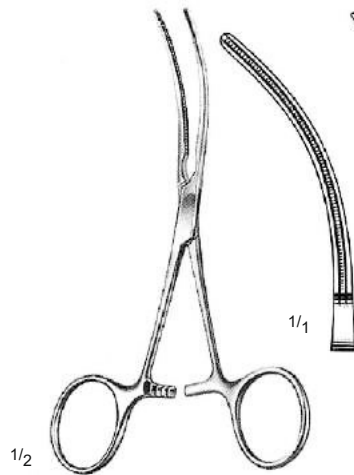

DE BAKEY
SF-01-11770
11 cm / 4 1/4"

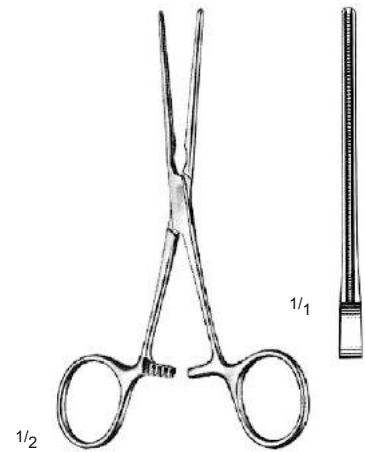

DE BAKEY
SF-01-11771
12 cm / 4 3/4"

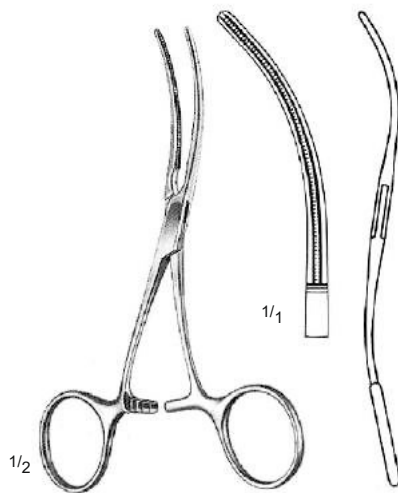

DE BAKEY
SF-01-11772
12 cm / 4 3/4"

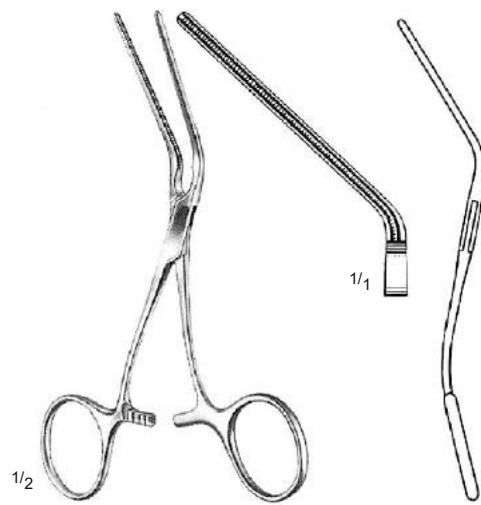

DE BAKEY
SF-01-11773
13 cm / 5"

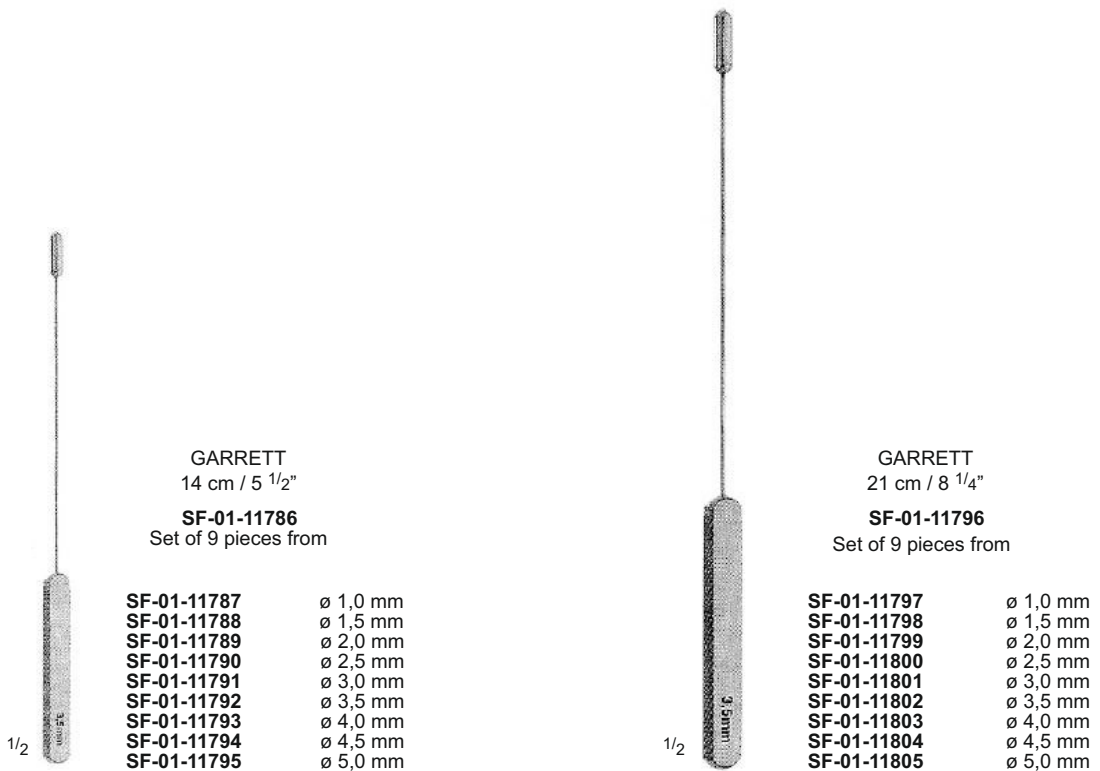
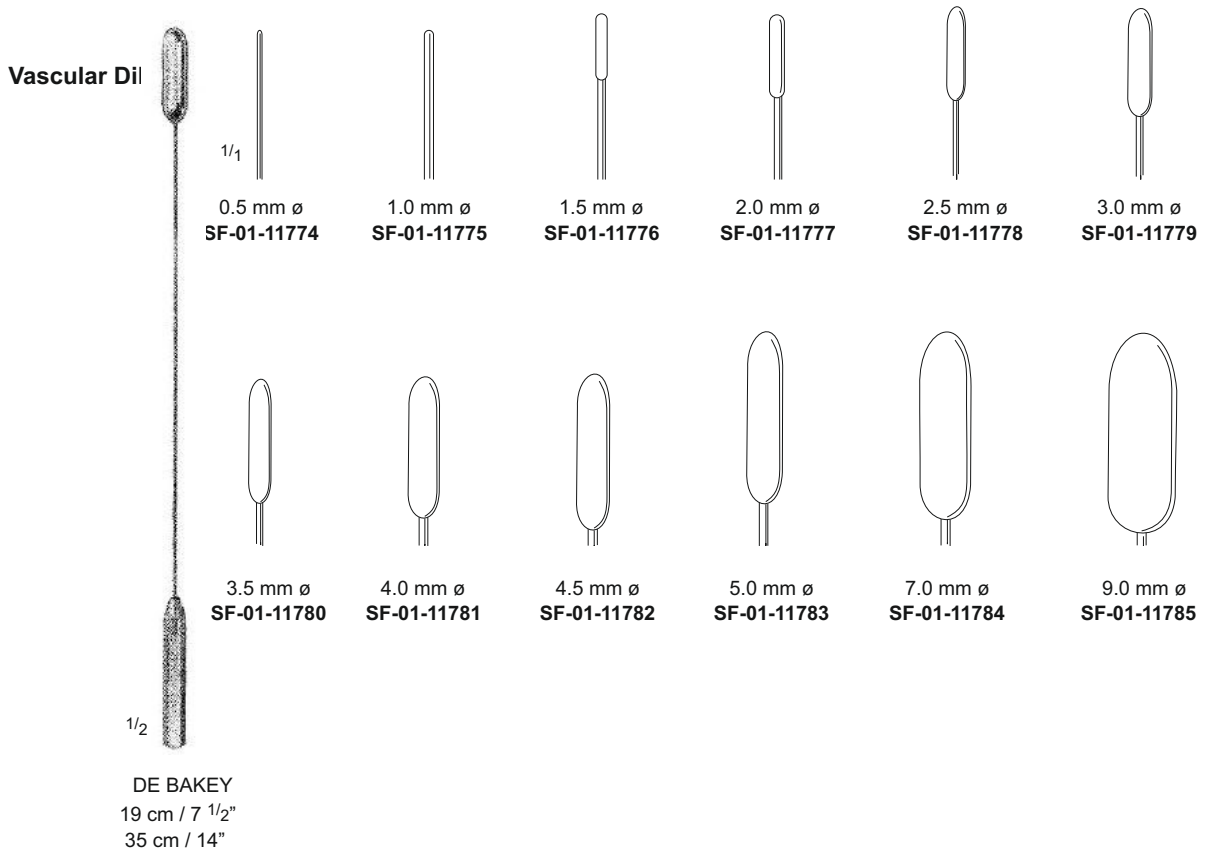

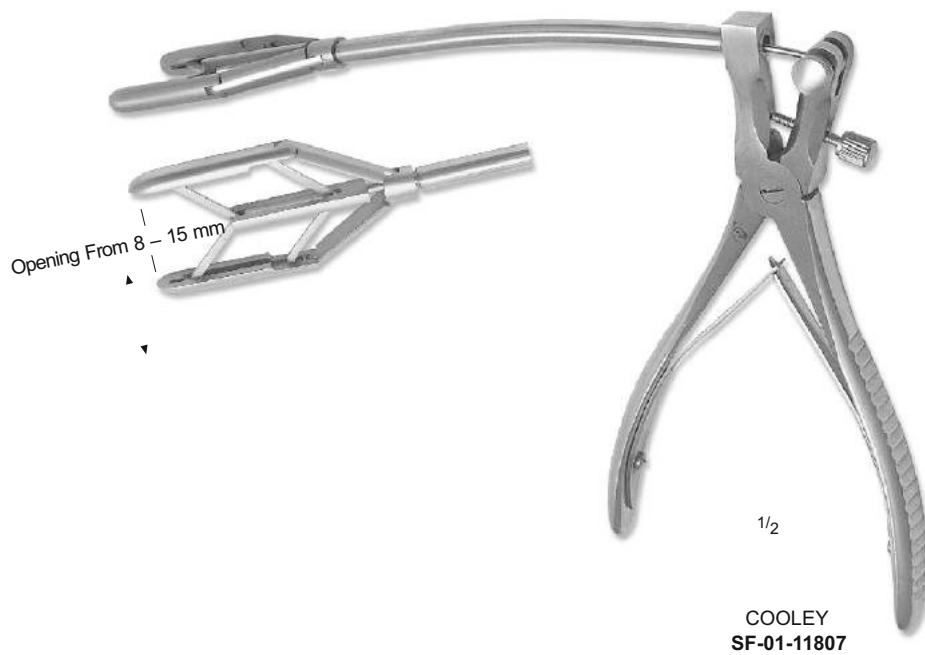
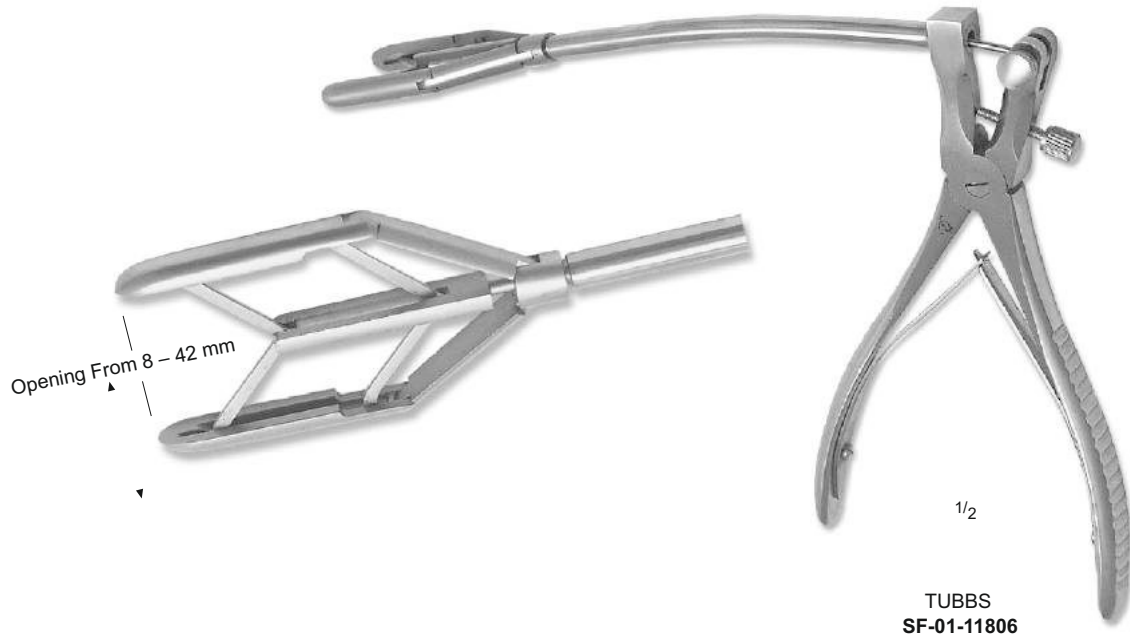

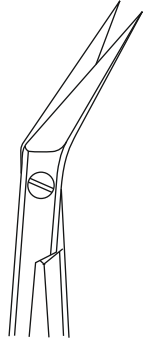

SF-01-11808
25°



SF-01-11809
25°

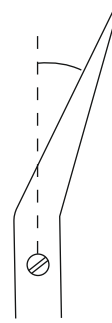

SF-01-11810
25°

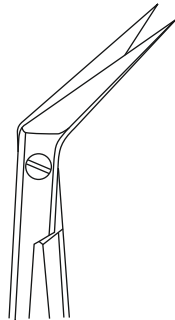

SF-01-11811
45°

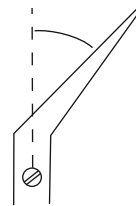

SF-01-11812
45°

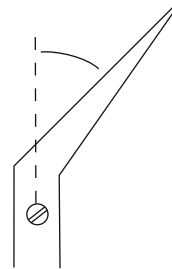

SF-01-11813
45°

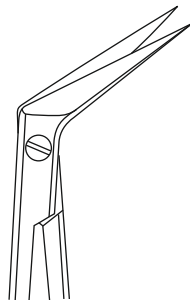

SF-01-11814
60°

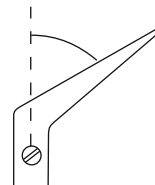

SF-01-11815
60°

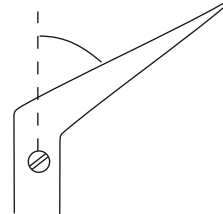

SF-01-11816
60°

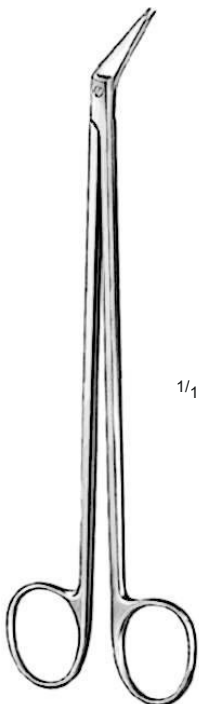

POTTS SMITH
19 cm / 7 1/2"

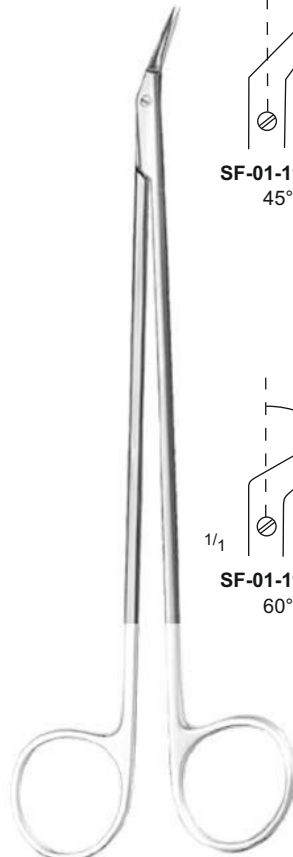

POTTS SMITH, T/C
19 cm / 7 1/2"
23 cm / 9"



SF-01-11817
18 cm / 7"
25°

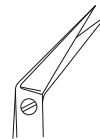

SF-01-11818
18 cm / 7"
45°

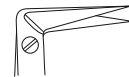

SF-01-11819
17 cm / 6 3/4"
90°

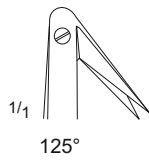

SF-01-11820
17.5 cm / 7"
60°

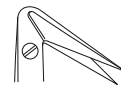

SF-01-11821
17 cm / 6 3/4"
125°

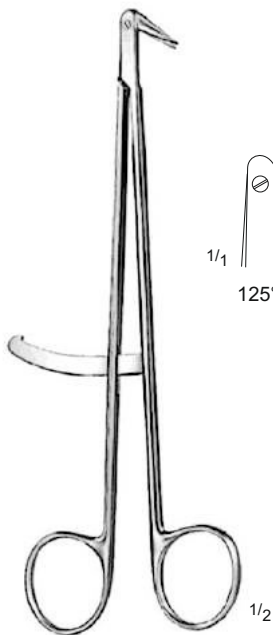

DIETRICH
18 cm / 7"



DIETRICH

Ear Instruments





1/2 KRAUSE
SF-01-11822



1/2 KRUSE-VOSS
SF-01-11823

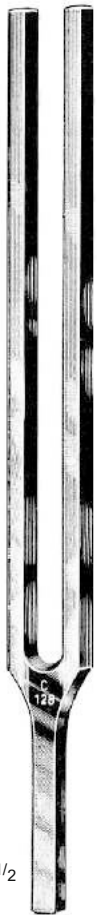

1/2 HARTMAN
SF-01-11824
C-128

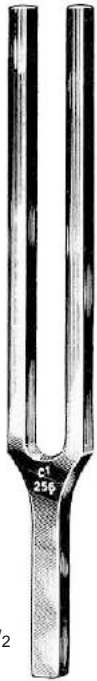

1/2 HARTMAN
SF-01-11825
C1 - 256



1/2 HARTMAN
SF-01-11826
C2 - 512



1/2 HARTMAN
SF-01-11827
C3 - 1024



1/2 HARTMAN
SF-01-11828
C4 - 2048



1/2 HARTMAN
SF-01-11829
C5 - 4096

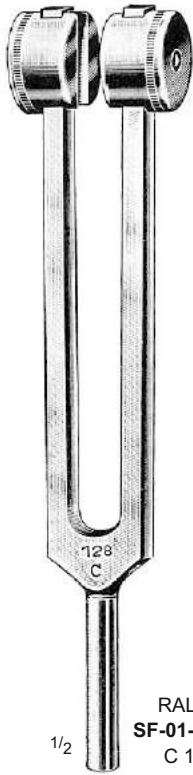

RALKS
SF-01-11830
C 128

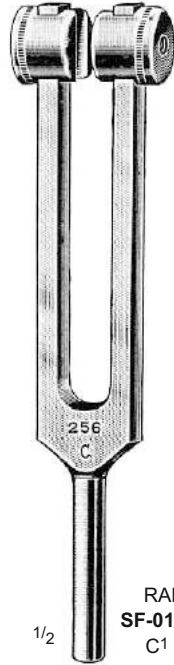

RALKS
SF-01-11831
C1 256

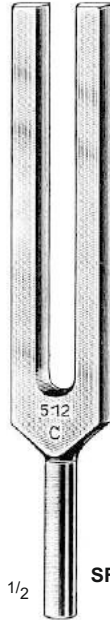

RALKS
SF-01-11832
C2 512

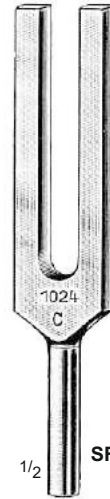

RALKS
SF-01-11833
C3 1024



RALKS
SF-01-11834
C4 2048

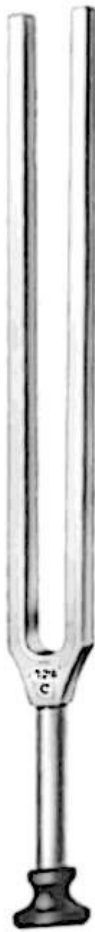

LUCAE
SF-01-11835
C 128

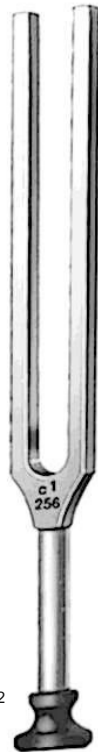

LUCAE
SF-01-11836
C1 256



LUCAE
SF-01-11837
C2 512





LUCAE
SF-01-11838
C3 1024











LUCAE
SF-01-11839
C4 2048



LUCAE
SF-01-11840
C5 4096

-  \varnothing 3 mm
SF-01-11841
Fig. 0
-  \varnothing 4 mm
SF-01-11842
Fig. 1
- $\frac{1}{1}$  \varnothing 5 mm
SF-01-11843
Fig. 2

-  \varnothing 4 mm
SF-01-11847
Fig. 1
-  \varnothing 5 mm
SF-01-11848
Fig. 2
-  \varnothing 6.0 mm
SF-01-11849
Fig. 3
- $\frac{1}{1}$  \varnothing 7.5 mm
SF-01-11850
Fig. 4

-  4.5 mm
SF-01-11851
-  5.5 mm
SF-01-11852
-  6.5 mm
SF-01-11853
-  7.5 mm
SF-01-11854



HARTMAN
(For Children)
SF-01-11844
Set of 3 (FIG 0,1,2)



HARTMAN
(For Adults)
SF-01-11845 Set of 3 (Fig 2,3,4)
SF-01-11846 Set of 4 (Fig 1,2,3,4)









GRUBER
SF-01-11855
(Set of 4)







TOYNBEE
(For Adults)
SF-01-11863 Set of 3 (Fig 2,3,4)
SF-01-11864 Set of 4 (Fig 1,2,3,4)



FARRIOR
(Black)

-  \varnothing 5.5 mm
SF-01-11856
-  \varnothing 6.5 mm
SF-01-11857
-  \varnothing 7.5 mm
SF-01-11858
-  \varnothing 8.5 mm
SF-01-11859
-  \varnothing 9.5 mm
SF-01-11860
-  \varnothing 10.5 mm
SF-01-11861
- $\frac{1}{1}$  \varnothing 11.5 mm
SF-01-11862

-  \varnothing 3.0 mm
SF-01-11867
Fig. 1
-  \varnothing 4.5 mm
SF-01-11868
Fig. 2
-  \varnothing 5.5 mm
SF-01-11869
Fig. 3
- $\frac{1}{1}$  \varnothing 6.5 mm
SF-01-11870
Fig. 4



POLTIZER
SF-01-11865
Set of 3 (Fig.1, 2, 3)
SF-01-11866
Set of 4 (Fig. 1, 2, 3, 4)



Complete Set in leather case
with 2 spare specula
SF-01-11871



SF-01-11873



SF-01-11872

4 x 4 mm
SF-01-11874



5 x 5 mm
SF-01-11875



6 x 6 mm
SF-01-11876

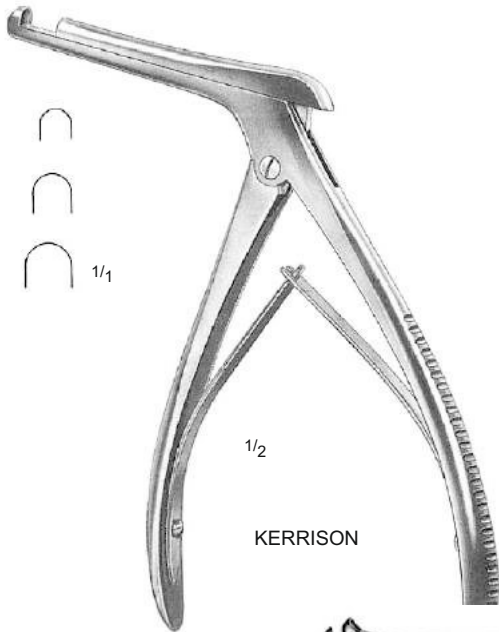

1/2

KERRISON

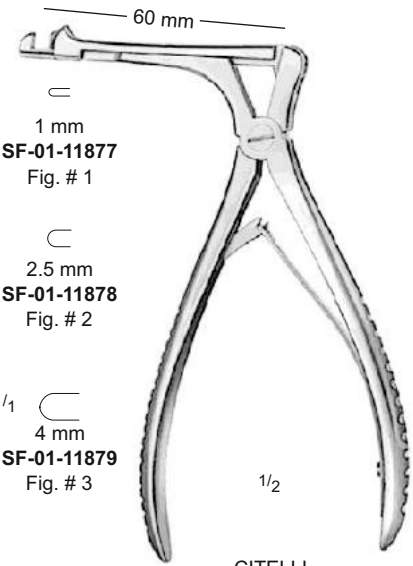

60 mm

1 mm
SF-01-11877
Fig. # 1

2.5 mm
SF-01-11878
Fig. # 2

1/1 4 mm
SF-01-11879
Fig. # 3

1/2

CITELLI

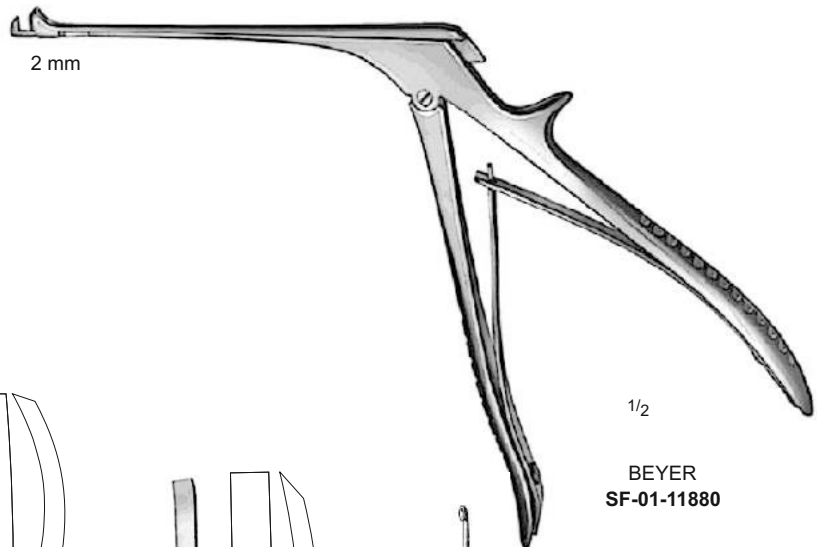

2 mm

1/2

BEYER
SF-01-11880



BARTH
SF-01-11881
18 cm / 7 1/2"
Sharp

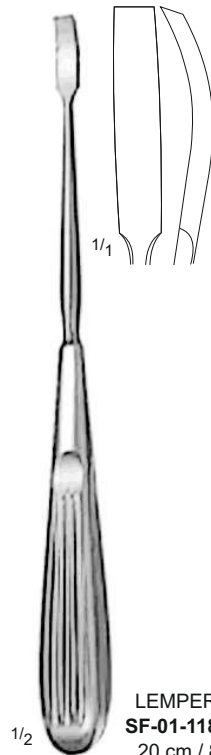

1/1

1/2

LEMPERT
SF-01-11882
20 cm / 8"
Sharp



1/1

1/2

LEMPERT
SF-01-11883
18 cm / 7"



1/2

LEMPERT
SF-01-11884
17.5 cm / 7"

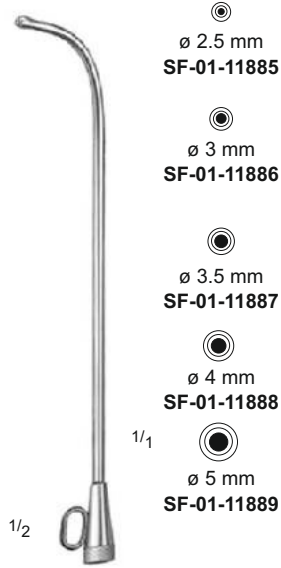

HARTMANN
24. 63.07 – 24. 63.15
14 cm / 5 1/2"



SF-01-11890 = 50 ml
SF-01-11891 = 100 ml
Ear Syringe Complete with
1 bulbous and 1 conical tip
and 1 protective shield.

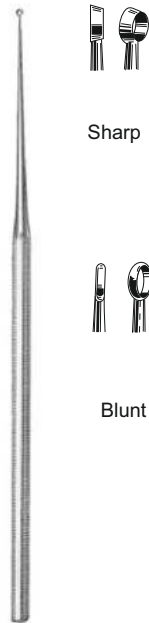

BUCK
16.5 cm / 6 1/2"

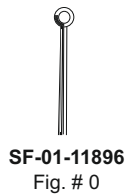
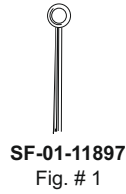

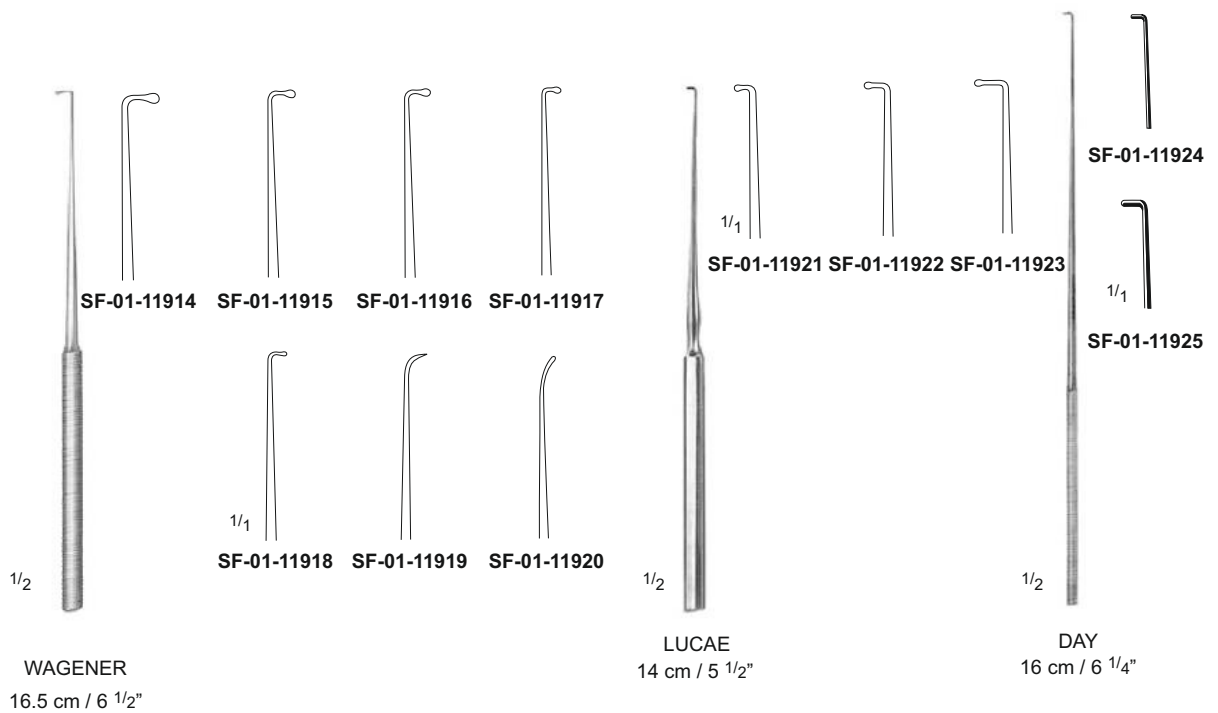
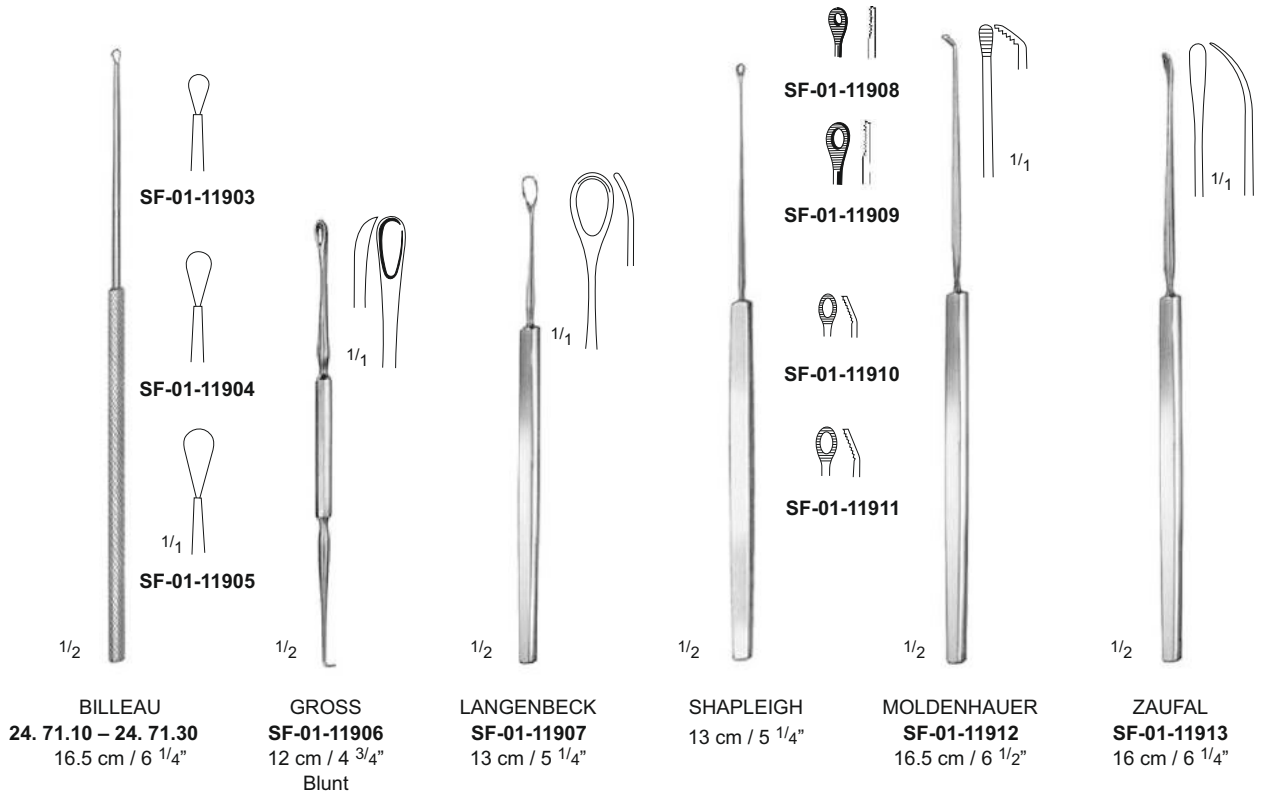

Vertical Needle

Horizontal Needle



POLITZER
SF-01-11926
16 cm / 6 1/4"

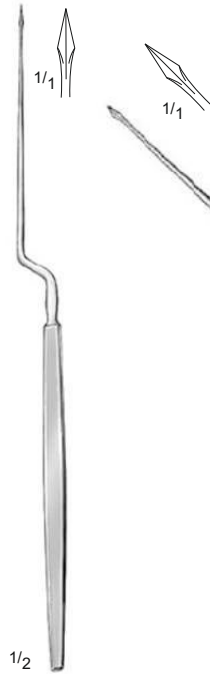

POLITZER
SF-01-11927
18 cm / 7 1/4"



POLITZER
SF-01-11928
16.5 cm / 6 1/2"



POLITZER
SF-01-11929
16.5 cm / 6 1/2"



POLITZER
SF-01-11930
16 cm / 6 1/4"

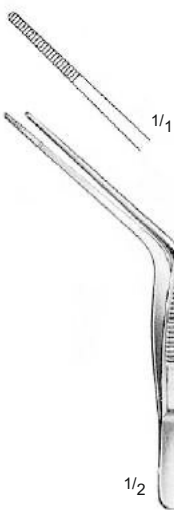

TROELTSCH (WILDE)
SF-01-11931
11 cm / 4 1/2"



TROELTSCH (WILDE)
SF-01-11932
12 cm / 4 3/4"

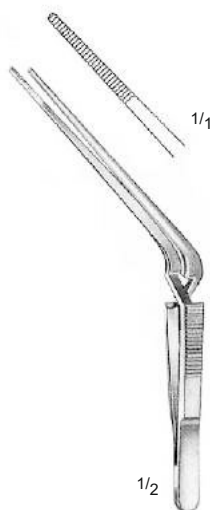













TROELTSCH (WILDE)
SF-01-11933
13 cm / 5"



LUCAE
SF-01-11934
14 cm / 5 1/2"

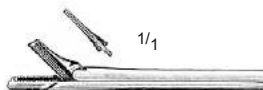
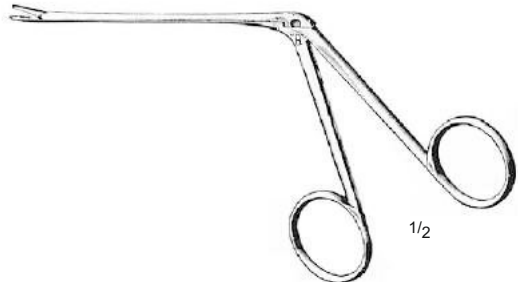

JANSEN
SF-01-11935
16 cm / 6 1/4"

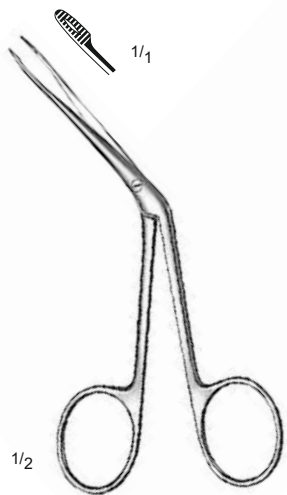
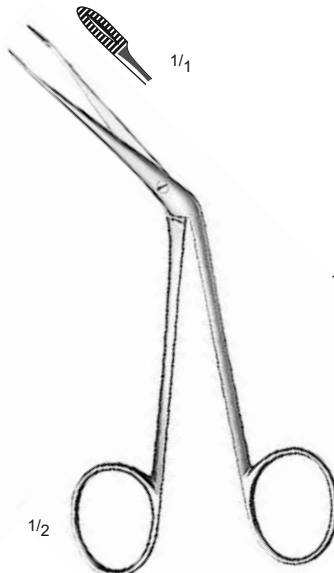
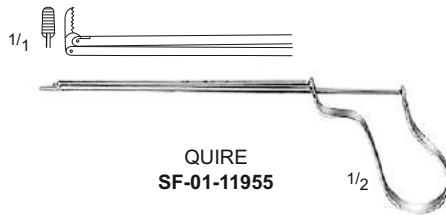
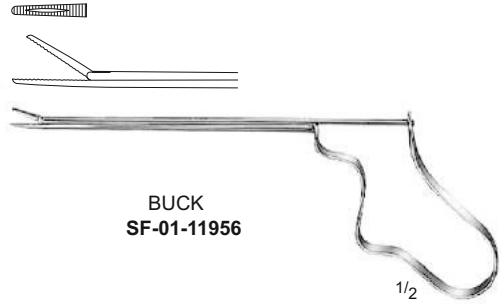
 <p>HARTMANN SF-01-11936 8.5 cm / 3 1/2"</p>	<p>○ 1 mm ø</p>  <p>WULLSTEIN SF-01-11937 8.5 cm / 3 1/2"</p>	 <p>HARTMANN SF-01-11938 = 8.5 cm / 3 1/2" SF-01-11939 = 12 cm / 4 3/4" SF-01-11940 = 14 cm / 5 1/2" SF-01-11941 = 16 cm / 6 1/2"</p>	 <p>HARTMANN SF-01-11942 = 8.5 cm / 3 1/2"</p>
 <p>HARTMANN-NOYES SF-01-11943 9 cm / 3 1/2"</p>	 <p>HARTMANN-NOVES SF-01-11944 9 cm / 3 1/2"</p>	 <p>HARTMANN-WEINGARTNER SF-01-11945 8.5 cm / 3 1/2"</p>	 <p>HARTMANN SF-01-11946 8.5 cm / 3 1/2"</p>
<p>○ 2.0 mm ø ○ 2.5 mm ø ○ 3 mm ø</p>  <p>HARTMANN-WULLSTEIN SF-01-11947 = 2.0 mm Ø SF-01-11948 = 2.5 mm Ø SF-01-11949 = 3.0 mm Ø</p>	<p>○ 3 mm ø</p>  <p>HARTMANN SF-01-11950 8.5 cm / 3 1/2"</p>	 <p>STRUEMPEL SF-01-11951 8.5 cm / 3 1/2"</p>	 <p>STRUYCKEN SF-01-11952 8.5 cm / 3 1/2"</p>
 <p>1/2</p>	 <p>STRUYCKEN SF-01-11953 8.5 cm / 3 1/2"</p>	<p>0.2 mm</p>  <p>HARTMANN-HOFFMANN SF-01-11954 8.5 cm / 3 1/2"</p>	
 <p>1/2</p> <p>HARTMANN SF-01-11957 Delicate 12 cm / 4 3/4"</p>	 <p>1/2</p> <p>HARTMANN SF-01-11958 Standard 14 cm / 5 1/2"</p>	 <p>1/1</p> <p>QUIRE SF-01-11955 1/2</p>  <p>1/1</p> <p>BUCK SF-01-11956 1/2</p>	

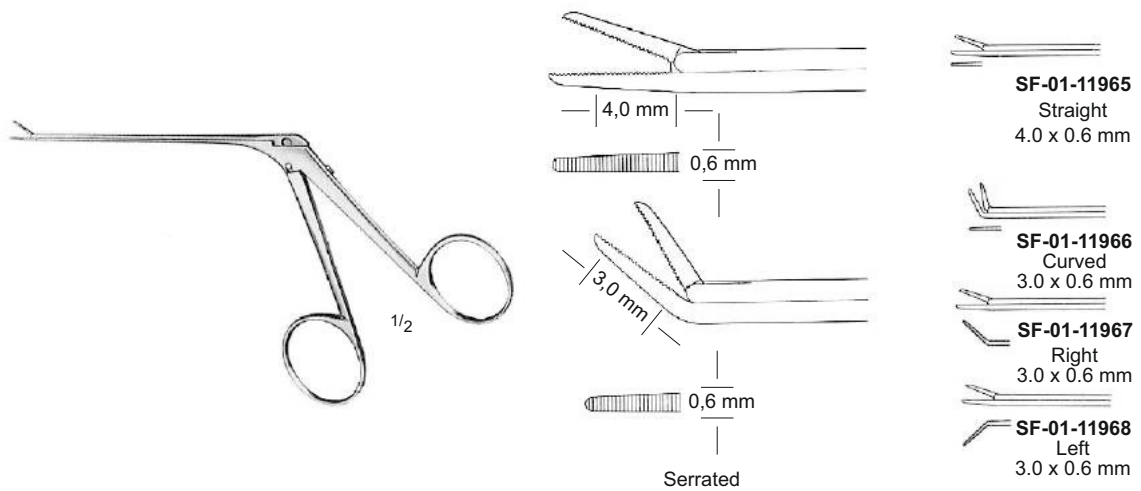
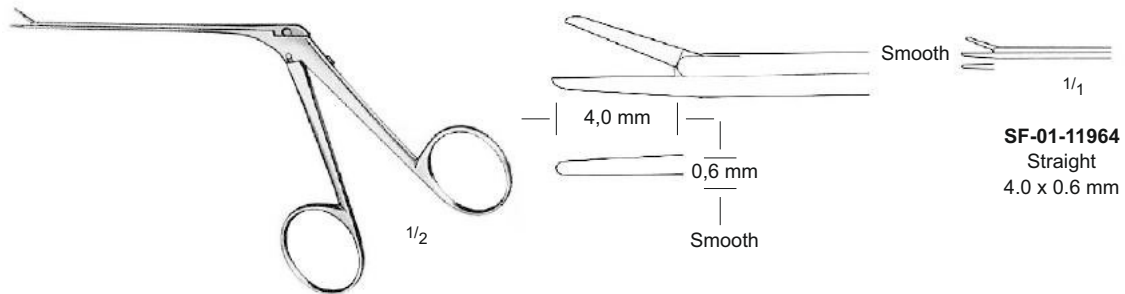
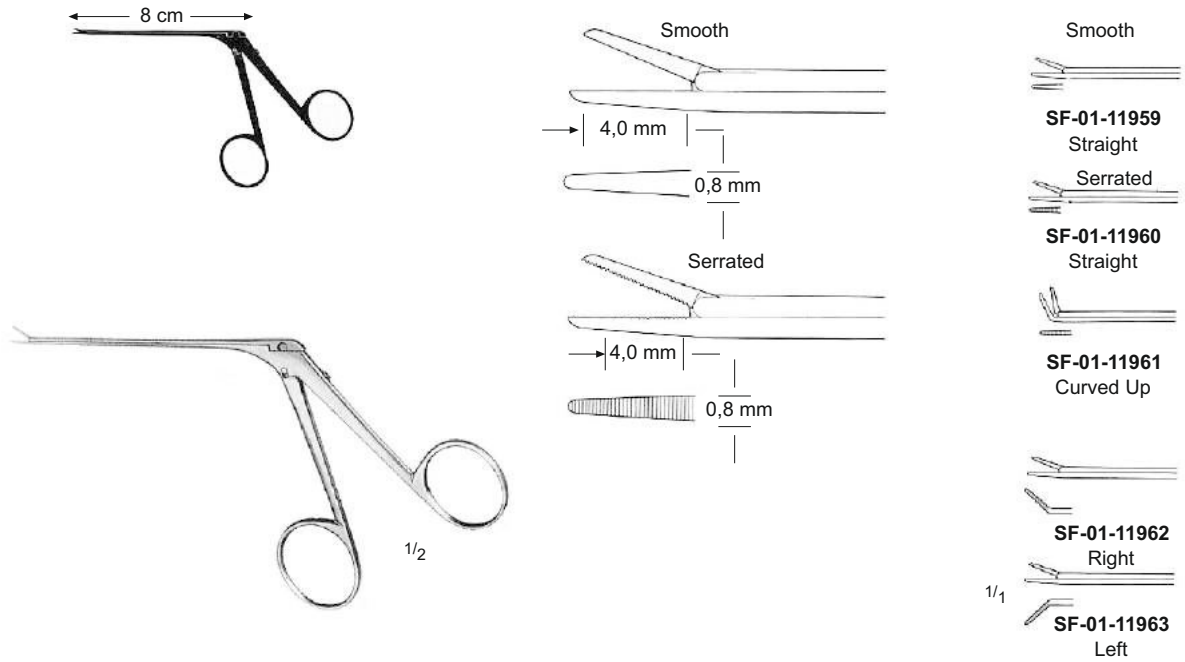

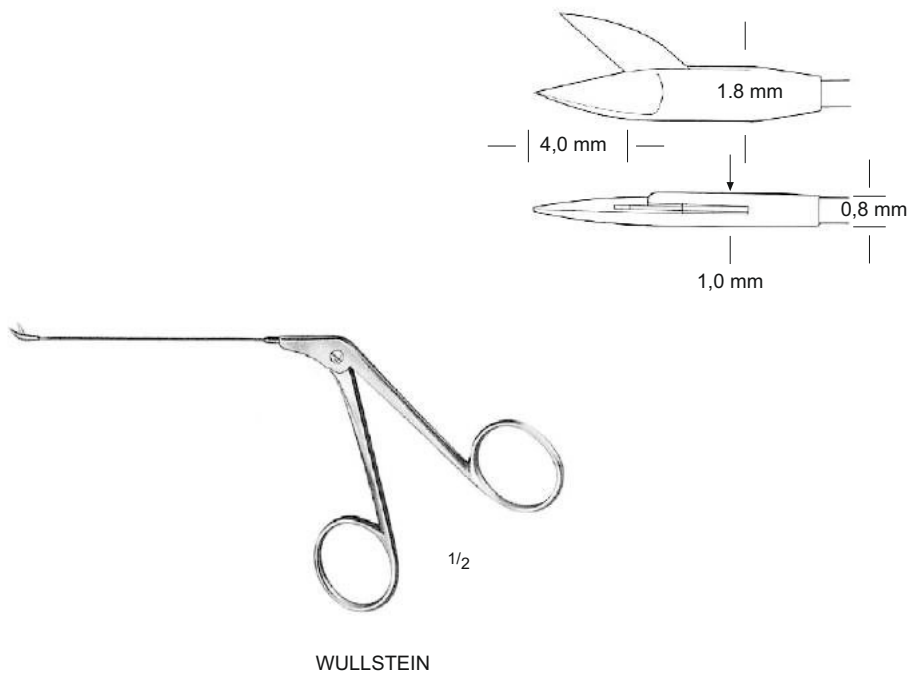
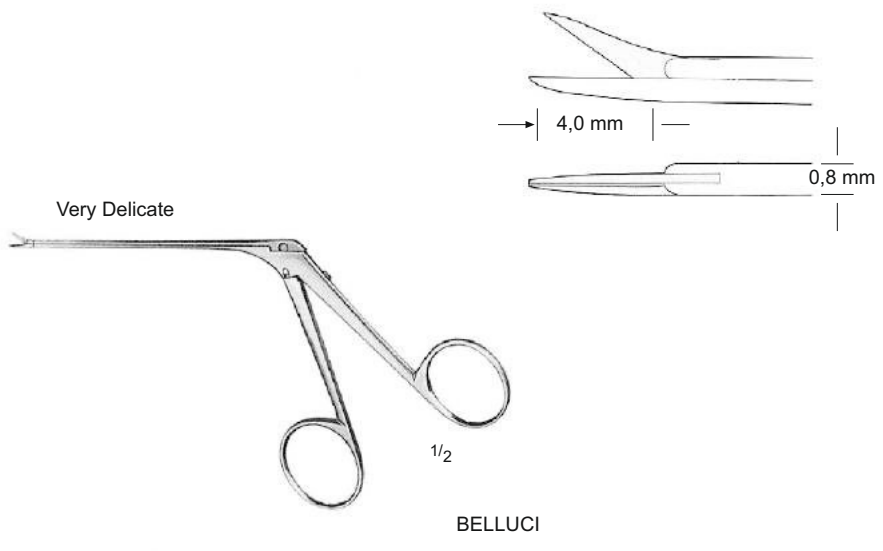

Laryngoscopes



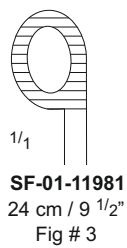
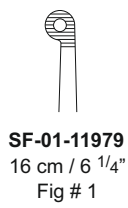
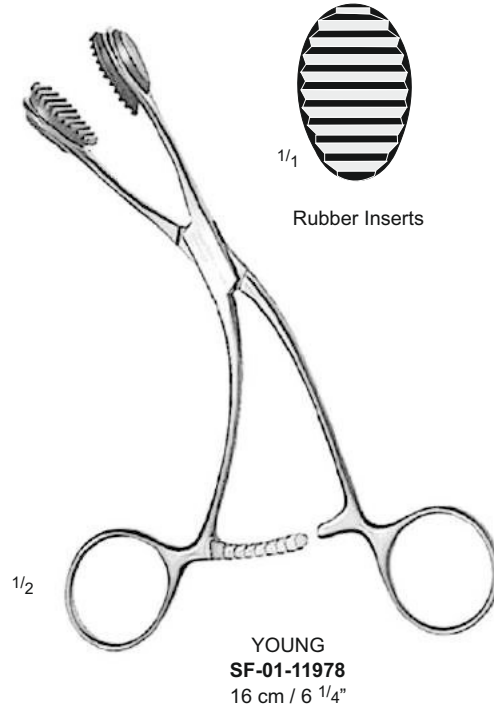
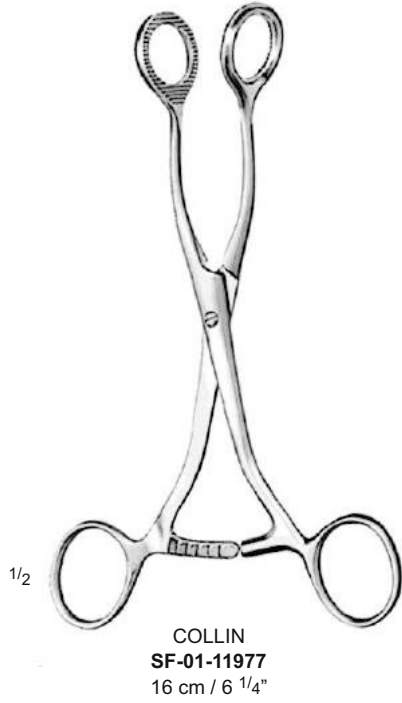

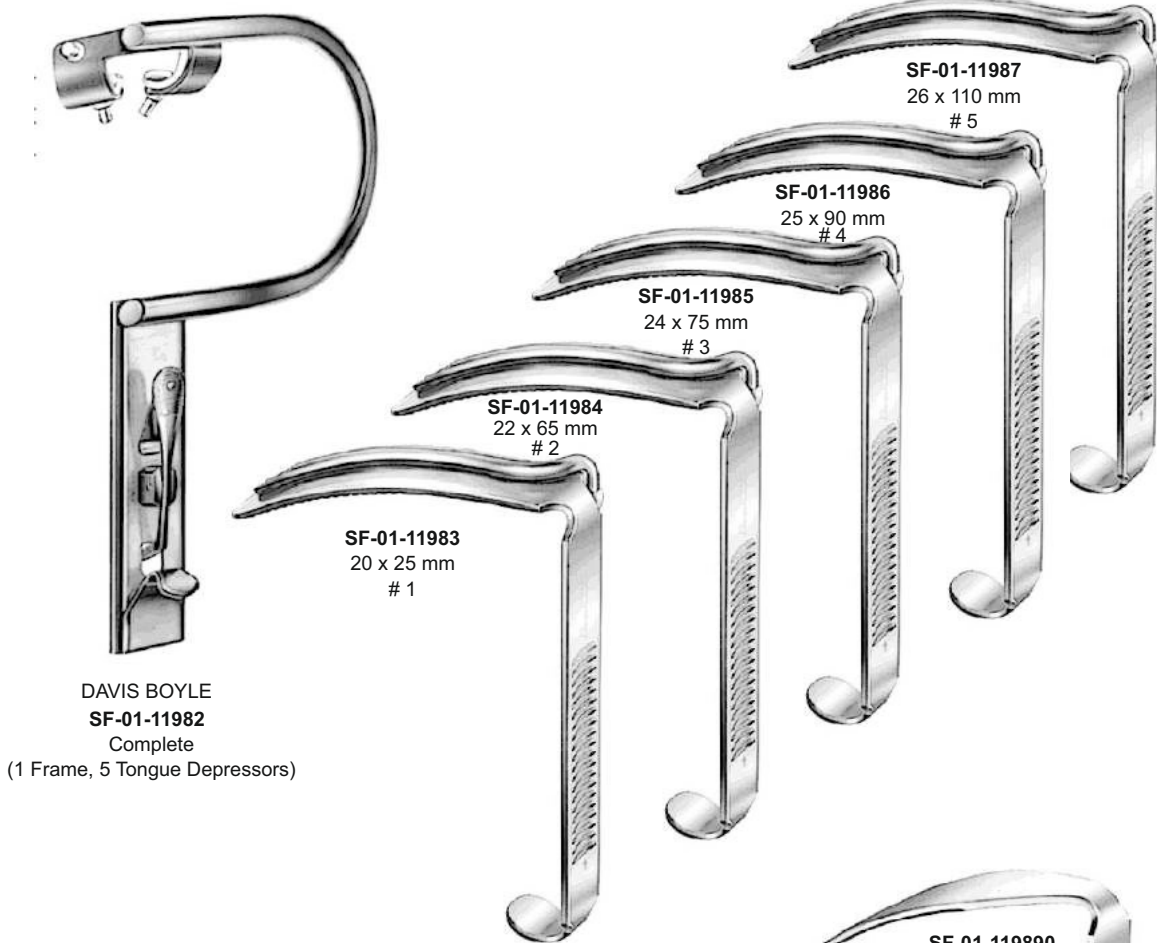

DAVIS BOYLE
SF-01-11982
Complete
(1 Frame, 5 Tongue Depressors)

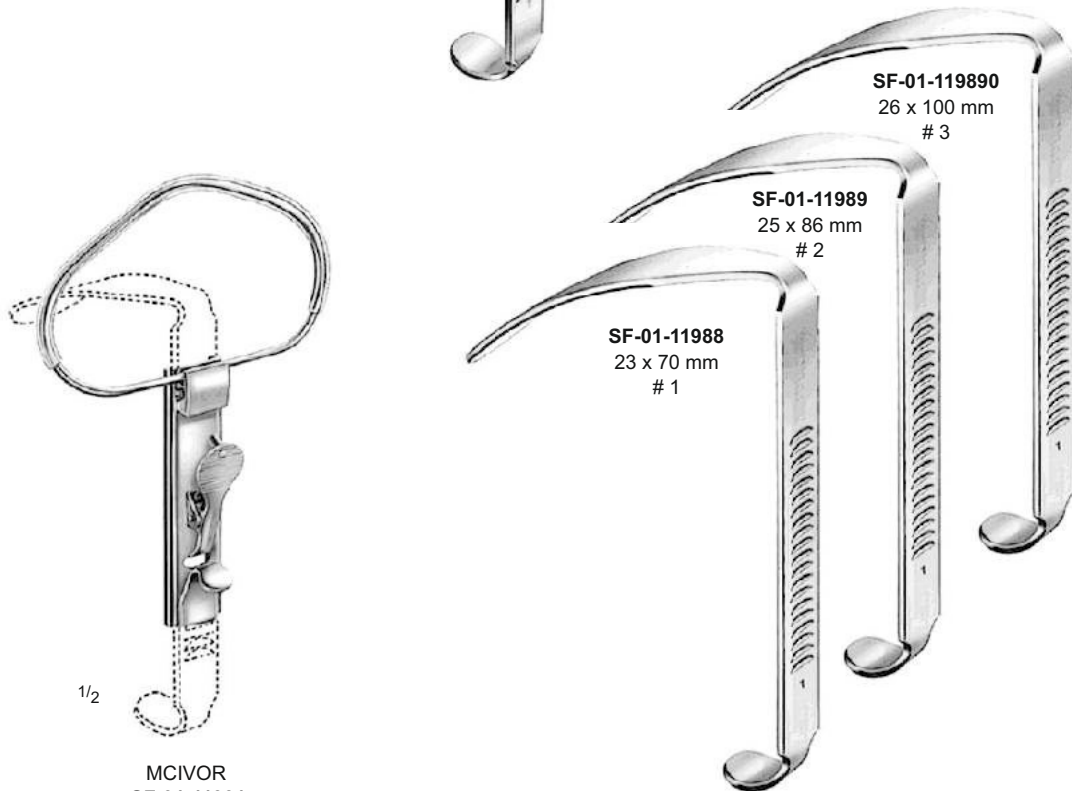

MCIVOR
SF-01-11991
Complete
(1 Frame, 3 Tongue Depressors)



MCINTOSH (CONVENTIONAL)

Wooden Box	Artificial Leather Emergency Bag	Contents
SF-01-11992	SF-01-11996	Set of 3 blades No. 2,3,4
SF-01-11993	SF-01-11997	Set of 4 blades No. 0,1,2,3 (Pediatric)
SF-01-11994	SF-01-11998	Set of 4 blades No. 1,2,3,4
SF-01-11995	SF-01-11999	Set of 5 blades, No. 1,2,3,4,5

All sets include 1 standard battery handle
and 2 spare lamps

MCINTOSH (FIBEROPTIC)

Wooden Box	Artificial Leather Emergency Bag	Contents
SF-01-12000	SF-01-12004	Set of 3 blades No. 2,3,4
SF-01-12001	SF-01-12005	Set of 4 blades No. 0,1,2,3 (Pediatric)
SF-01-12002	SF-01-12006	Set of 4 blades No. 1,2,3,4
SF-01-12003	SF-01-12007	Set of 5 blades, No. 1,2,3,4,5

All sets include 1 standard battery handle
and 2 spare lamps



WIS-FOREGGER (CONVENTIONAL)

Wooden Box	Artificial Leather Emergency Bag	Contents
SF-01-12008	SF-01-12012	Set of 3 blades No. 2,3,4
SF-01-12009	SF-01-12013	Set of 4 blades No. 0,1,2,3 (Pediatric)
SF-01-12010	SF-01-12014	Set of 4 blades No. 1,2,3,4
SF-01-12011	SF-01-12015	Set of 5 blades, No. 1,2,3,4,5

All sets include 1 standard battery handle and 2 spare lamps

WIS-FOREGGER (FIBRE OPTIC)

Wooden Box	Artificial Leather Emergency Bag	Contents
SF-01-12016	SF-01-12020	Set of 3 blades No. 2,3,4
SF-01-12017	SF-01-12021	Set of 4 blades No. 0,1,2,3 (Pediatric)
SF-01-12018	SF-01-12022	Set of 4 blades No. 1,2,3,4
SF-01-12019	SF-01-12023	Set of 5 blades, No. 1,2,3,4,5

All sets include 1 standard battery handle and 2 spare lamps



25. 28.20 – 25. 28.28
25. 48.40 – 25. 48.56

MILLER (CONVENTIONAL)

Wooden Box	Artificial Leather Emergency Bag	Contents
SF-01-12024	SF-01-12028	Set of 3 blades No. 1,2,3
SF-01-12025	SF-01-12029	Set of 4 blades No. 0,1,2,3 (Pediatric)
SF-01-12026	SF-01-12030	Set of 4 blades No. 1,2,3,4
SF-01-12027	SF-01-12031	Set of 5 blades, No. 1,2,3,4,5

All sets include 1 standard battery handle and 2 spare lamps

MILLER (FIBRE OPTIC)

Wooden Box	Artificial Leather Emergency Bag	Contents
SF-01-12032	SF-01-12036	Set of 3 blades No. 1,2,3
SF-01-12033	SF-01-12037	Set of 4 blades No. 0,1,2,3 (Pediatric)
SF-01-12034	SF-01-12038	Set of 4 blades No. 1,2,3,4
SF-01-12035	SF-01-12039	Set of 5 blades, No. 1,2,3,4,5

All sets include 1 standard battery handle and 2 spare lamps

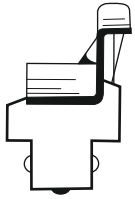

SF-01-12040
Fig. 0, 55 mm
For Premature Babies



SF-01-12041
Fig. 1, 70 mm
For Infants



SF-01-12042
Fig. 2, 90 mm
For Children



SF-01-12043
Fig. 3, 110 mm
For Adults, Medium



SF-01-12044
Fig. 4, 130 mm
For Adults, Large



SF-01-12045
Fig. 5, 150 mm
For Adults, Extra Large

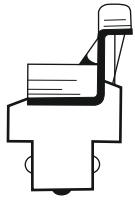

SF-01-12046
Fig. 0, 55 mm
For Premature Babies



SF-01-12047
Fig. 1, 70 mm
For Infants



SF-01-12048
Fig. 2, 90 mm
For Children



SF-01-12049
Fig. 3, 110 mm
For Adults, Medium



SF-01-12050
Fig. 4, 130 mm
For Adults, Large



SF-01-12051
Fig. 0, 55 mm
For Premature Babies



SF-01-12052
Fig. 1, 70 mm
For Infants



SF-01-12053
Fig. 2, 90 mm
For Children



SF-01-12054
Fig. 3, 110 mm
For Adults, Medium



SF-01-12055
Fig. 4, 135 mm
For Adults, Large



SF-01-12056
Fig. 0, 55 mm
For Premature Babies



SF-01-12057
Fig. 1, 70 mm
For Infants



SF-01-12058
Fig. 2, 90 mm
For Children



SF-01-12059
Fig. 3, 110 mm
For Adults, Medium



SF-01-12060
Fig. 4, 135 mm
For Adults, Large



SF-01-12061
Fig. 0, 55 mm
For Premature Babies



SF-01-12062
Fig. 1, 80 mm
For Infants



SF-01-12063
Fig. 2, 130 mm
For Children



SF-01-12064
Fig. 3, 170 mm
For Adults, Medium



SF-01-12065
Fig. 4, 180 mm
For Adults, Large

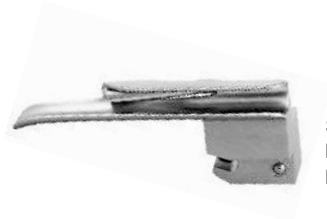

SF-01-12066
Fig. 0, 55 mm
For Premature Babies



SF-01-12067
Fig. 1, 80 mm
For Infants



SF-01-12068
Fig. 2, 130 mm
For Children



SF-01-12069
Fig. 3, 170 mm
For Adults, Medium



SF-01-12070
Fig. 4, 180 mm
For Adults, Large

25. 29.66



25. 29.65



FIBRE OPTIC
SF-01-12071
ø 24 mm
11 cm / 4 1/4"



STANDARD
SF-01-12072
ø 19 mm
13 cm / 5"



STANDARD
SF-01-12073
ø 28mm
14 cm / 5 1/2"



FIBRE OPTIC
SF-01-12074
ø 28mm
14 cm / 5 1/2"

DERMATOLOGY

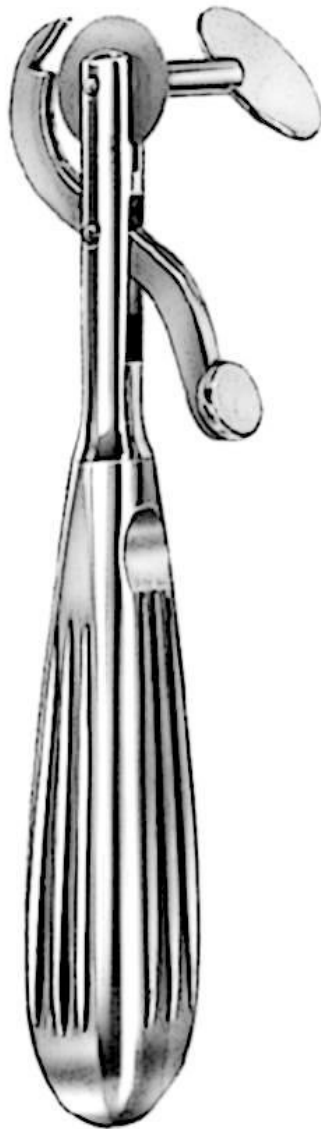

SF-01-12075
Spare Saw
Blade Only

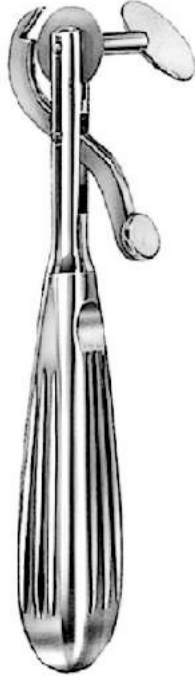

1/2

SF-01-12077
16 cm / 6 1/4"

SF-01-12076
Spare Saw
Blade Only



1/2

SF-01-12078
16 cm / 6 1/4"



1/2

SAALFELD
SF-01-12079
11 cm / 4 1/2"



1/2

SAALFELD
SF-01-12080
15 cm / 6"



1/2 1/1

UNNA
SF-01-12081
14 cm / 5 1/2"

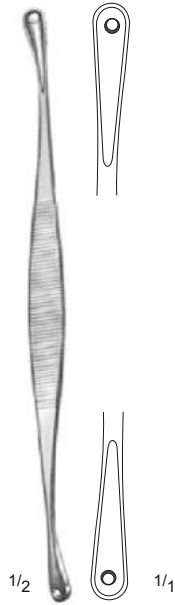

1/2 1/1

UNNA
SF-01-12082
14 cm / 5 1/2"



1/2

UNNA

Hole ø 1 mm
SF-01-12083

Hole ø 1.5 mm
SF-01-12084

Hole ø 2 mm
SF-01-12085



1/2

UNNA VIDAL
SF-01-12086

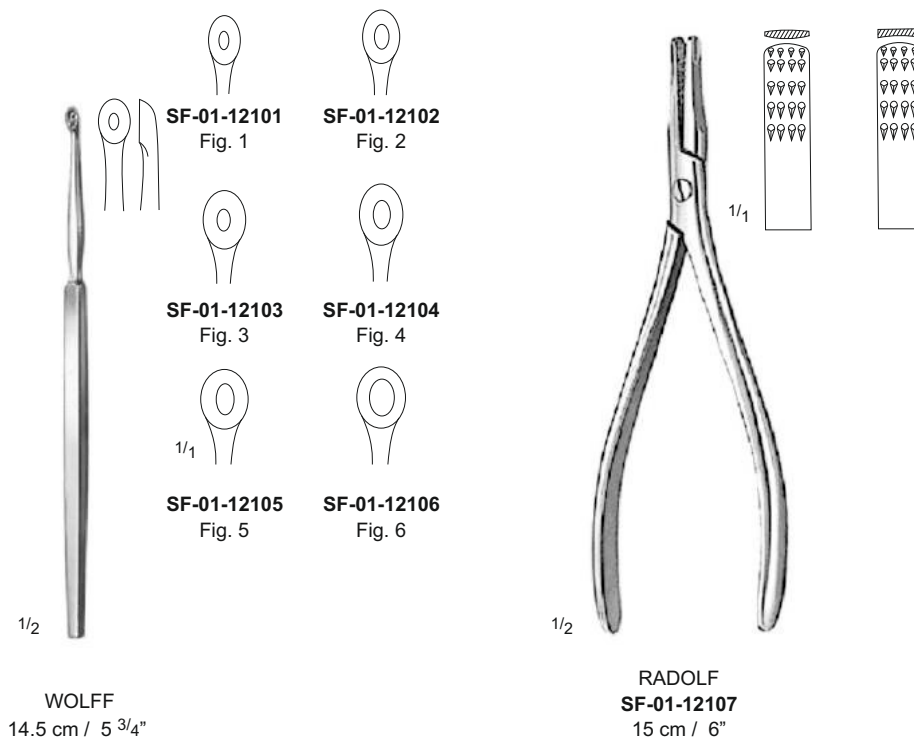
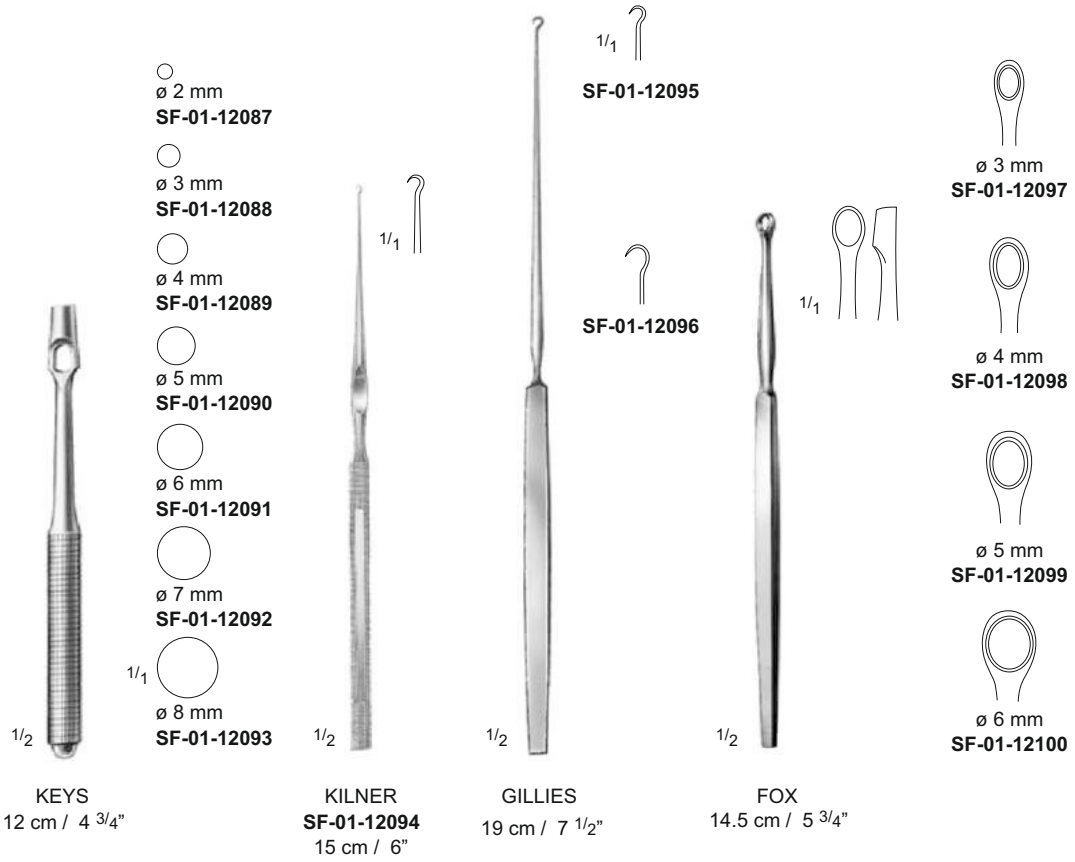

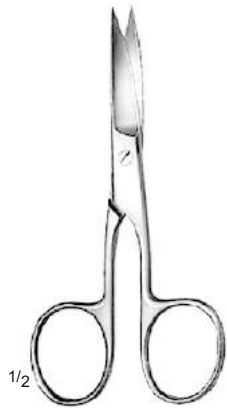

SF-01-12108
10.5 cm / 4 1/4"

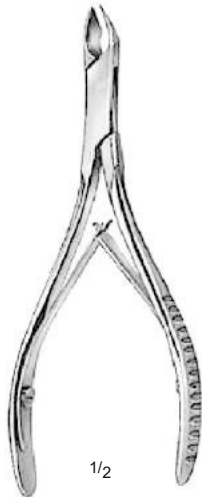

SF-01-12109 – 11 cm / 4 1/2"
SF-01-12110 – 13 cm / 5"



TURNBULL
SF-01-12111 – 11.5 cm / 4 1/2"
SF-01-12112 – 13 cm / 5"

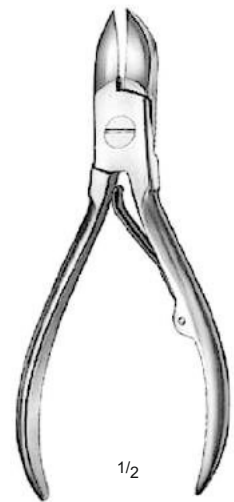

SF-01-12113
13 cm / 5"



SF-01-12114 – 14 cm / 5 1/2"
SF-01-12115 – 16 cm / 6 1/4"



SF-01-12116
14 cm / 5 1/2"



SF-01-12117 – 11 cm / 4 1/2"
SF-01-12118 – 13 cm / 5"
SF-01-12119 – 15 cm / 6"



SF-01-12120
13 cm / 5"

STERILIZATION





CHEATTLE
SF-01-12121
27 cm / 10 1/2"



SF-01-12122 – 20 cm / 8"
SF-01-12123 – 30 cm / 12"



with ball stop
BUNT (MAYO)
SF-01-12124
14 cm / 5 1/2"



BUNT (MAYO)
SF-01-12125
14 cm / 5 1/2"



Horizontal
Ventilation

SCHIMMELBUSCH

	∅	h
SF-01-12126	14	x 14 cm
SF-01-12127	16	x 15 cm
SF-01-12128	19	x 16 cm
SF-01-12129	19	x 19 cm
SF-01-12130	24	x 12 cm
SF-01-12131	24	x 16 cm
SF-01-12132	24	x 24 cm
SF-01-12133	29	x 16 cm
SF-01-12134	29	x 24 cm
SF-01-12135	34	x 16 cm
SF-01-12136	34	x 24 cm
SF-01-12137	39	x 14 cm
SF-01-12138	39	x 19 cm
SF-01-12139	39	x 29 cm



Vertical
Ventilation

KONRICH

	∅	h
SF-01-12140	14	x 14 cm
SF-01-12141	16	x 15 cm
SF-01-12142	19	x 16 cm
SF-01-12143	19	x 19 cm
SF-01-12144	24	x 12 cm
SF-01-12145	24	x 16 cm
SF-01-12146	24	x 24 cm
SF-01-12147	29	x 16 cm
SF-01-12148	29	x 24 cm
SF-01-12149	34	x 16 cm
SF-01-12150	34	x 24 cm
SF-01-12151	39	x 14 cm
SF-01-12152	39	x 19 cm
SF-01-12153	39	x 29 cm

	L	W	D
SF-01-12154	150 x	100 x	25 mm
SF-01-12155	200 x	150 x	38 mm
SF-01-12156	250 x	200 x	50 mm
SF-01-12157	300 x	250 x	50 mm
SF-01-12158	355 x	305 x	50 mm
SF-01-12159	405 x	305 x	50 mm
SF-01-12160	455 x	355 x	50 mm



	L	W	D
SF-01-12161	210 x	160 x	10 mm
SF-01-12162	240 x	180 x	10 mm
SF-01-12163	310 x	150 x	10 mm
SF-01-12164	310 x	210 x	10 mm
SF-01-12165	350 x	240 x	10 mm
SF-01-12166	400 x	270 x	10 mm
SF-01-12167	420 x	280 x	10 mm



SF-01-12168
 ø 200 x 70 mm



SF-01-12169
 235 x 190 x 40 mm

L = Length

W = Width

D = Depth

ø = Diameter



	∅	x	Height
SF-01-12170	75	x	60 mm
SF-01-12171	75	x	75 mm
SF-01-12172	100	x	60 mm
SF-01-12173	100	x	100 mm
SF-01-12174	125	x	80 mm
SF-01-12175	125	x	125 mm
SF-01-12176	150	x	150 mm



	L	W	D
SF-01-12177	170	x 100	x 35 mm
SF-01-12178	200	x 120	x 35 mm
SF-01-12179	250	x 140	x 40 mm
SF-01-12180	275	x 150	x 45 mm
SF-01-12181	305	x 140	x 50 mm



	∅	x	D	Capacity
SF-01-12182	165	x	60 mm	0.75 L
SF-01-12183	175	x	70 mm	1.0 L
SF-01-12184	220	x	80 mm	2.0 L
SF-01-12185	225	x	90 mm	2.5 L
SF-01-12186	240	x	110 mm	3.0 L
SF-01-12187	275	x	115 mm	4.5 L
SF-01-12188	290	x	125 mm	6.0 L
SF-01-12189	310	x	120 mm	6.0 L
SF-01-12190	345	x	125 mm	8.5 L
SF-01-12191	380	x	125 mm	11 L

L = Length W = Width D = Depth ∅ = Diameter



	∅	x	D	Capacity
SF-01-12192	167	x	62 mm	0.9 L
SF-01-12193	200	x	75 mm	1.4 L
SF-01-12194	230	x	82 mm	2.2 L
SF-01-12195	261	x	94 mm	3.0 L
SF-01-12196	292	x	103 mm	4.0 L
SF-01-12197	328	x	111 mm	5.7 L



	∅	x	Height
SF-01-12198	30	x	90 mm
SF-01-12199	50	x	100 mm
SF-01-12200	50	x	130 mm
SF-01-12201	50	x	175 mm
SF-01-12202	75	x	100 mm
SF-01-12203	75	x	130 mm
SF-01-12204	75	x	175 mm
SF-01-12205	100	x	175 mm
SF-01-12206	100	x	200 mm



SF-01-12207
25 cc



SF-01-12208
50 cc



SF-01-12209
∅ 90 x 90 mm, height



SF-01-12210
∅ 80 x 90 mm

L = Length W = Width D = Depth ∅ = Diameter

Style A



	L	W	D
SF-01-12211	165 x	90 x	35 mm
SF-01-12212	200 x	100 x	35 mm
SF-01-12213	200 x	100 x	50 mm
SF-01-12214	230 x	130 x	50 mm
SF-01-12215	260 x	150 x	50 mm
SF-01-12216	280 x	140 x	60 mm
SF-01-12217	300 x	200 x	50 mm

Style B



	L	W	D
SF-01-12218	165 x	90 x	35 mm
SF-01-12219	200 x	100 x	35 mm
SF-01-12220	200 x	100 x	50 mm
SF-01-12221	230 x	130 x	50 mm
SF-01-12222	280 x	140 x	60 mm
SF-01-12223	260 x	150 x	50 mm
SF-01-12224	300 x	200 x	50 mm

Style C



	L	W	D
SF-01-12225	165 x	90 x	35 mm
SF-01-12226	180 x	80 x	50 mm
SF-01-12227	200 x	100 x	35 mm
SF-01-12228	200 x	100 x	50 mm
SF-01-12229	230 x	130 x	50 mm
SF-01-12230	250 x	120 x	60 mm
SF-01-12231	260 x	180 x	50 mm
SF-01-12232	280 x	140 x	60 mm
SF-01-12233	300 x	200 x	50 mm
SF-01-12234	320 x	150 x	60 mm
SF-01-12235	360 x	160 x	70 mm

L = Length

W = Width

D = Depth

THORACIC Instruments



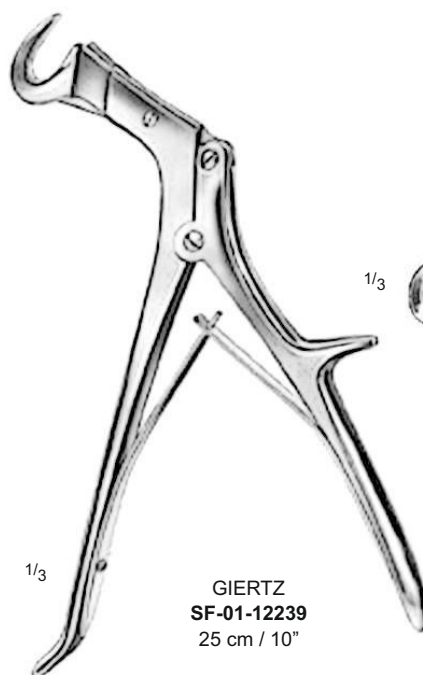
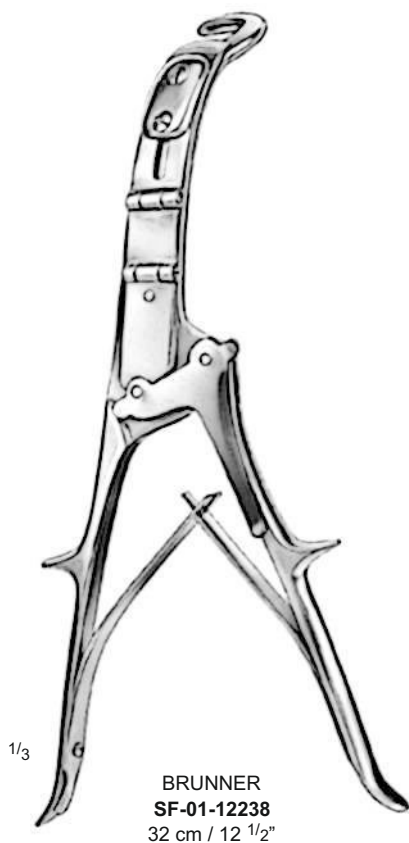

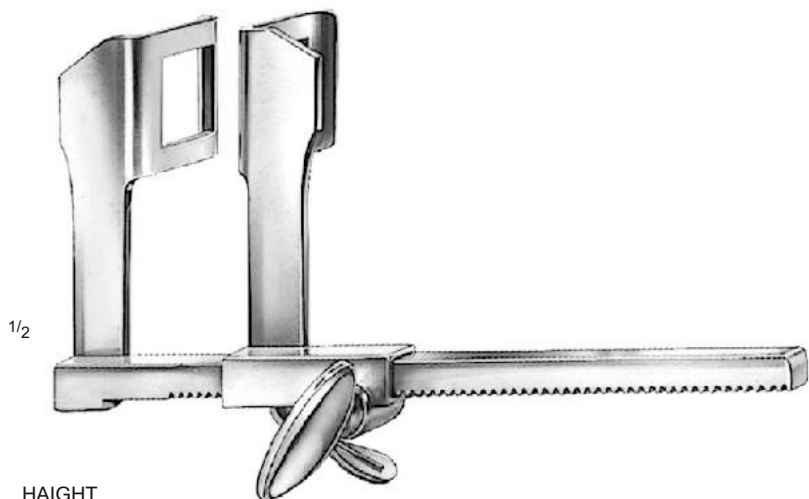

HAIGHT

	a	b	c
SF-01-12241	30 mm	30 mm	90 m / 3 1/2"

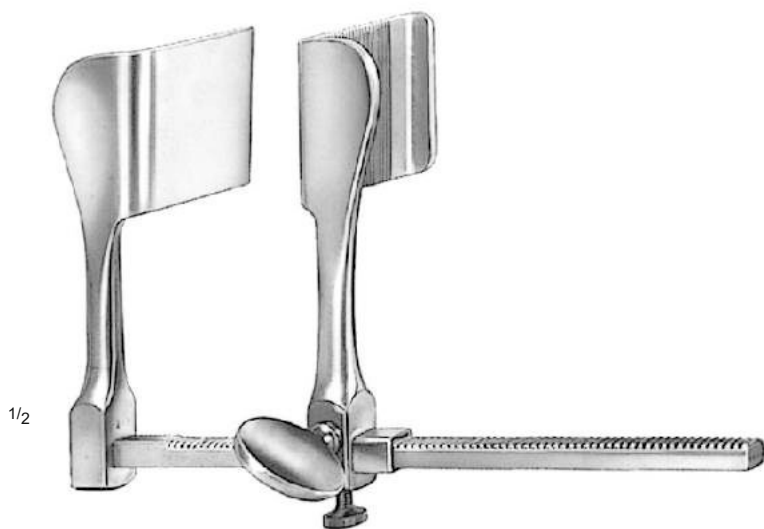
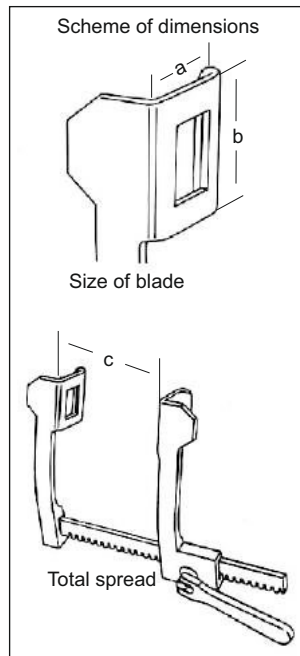

TUFFIER

	a	b	c
SF-01-12242	45 mm	45 mm	160 mm / 6 1/4"

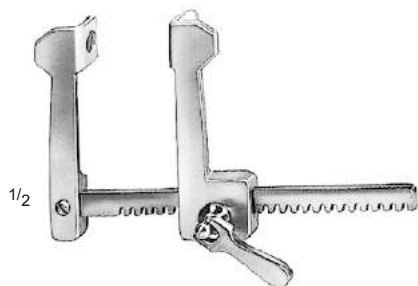

FINOCHIETTO - BABY

	a	b	c
SF-01-12243	15 mm	15 mm	75 mm / 2"

Scheme of dimensions

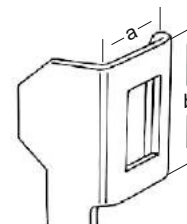

Size of blade

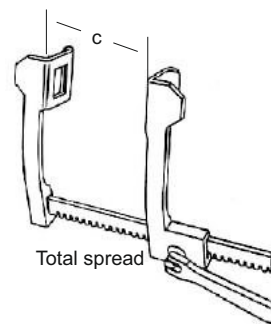

Total spread

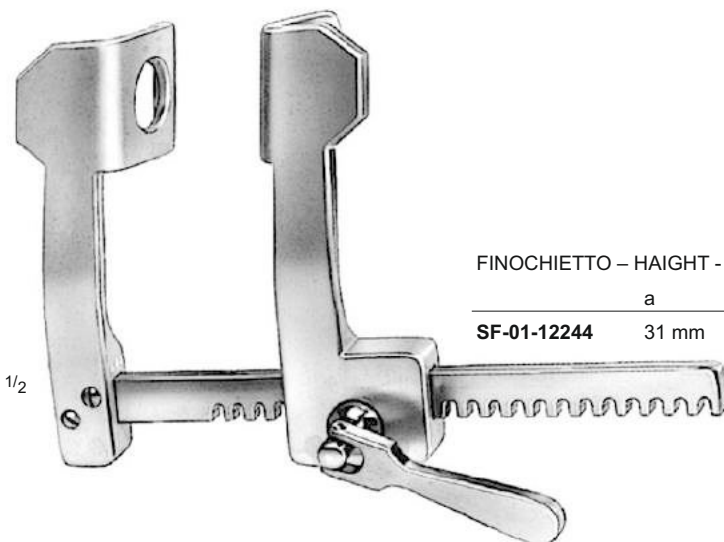

FINOCHIETTO - HAIGHT - BABY

	a	b	c
SF-01-12244	31 mm	31 mm	100 mm / 4"

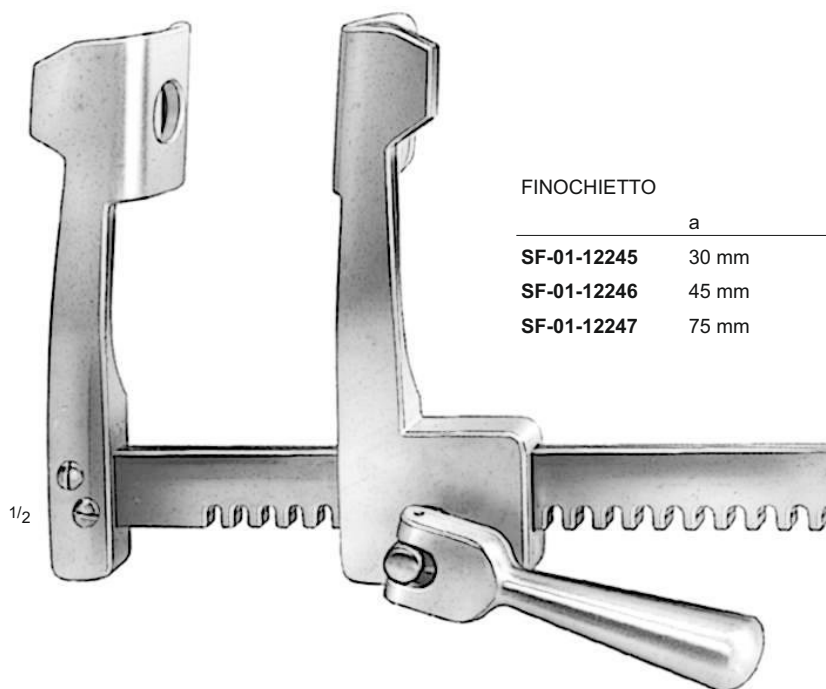

FINOCHIETTO

	a	b	c
SF-01-12245	30 mm	40 mm	150 mm / 6"
SF-01-12246	45 mm	65 mm	200 mm / 8"
SF-01-12247	75 mm	65 mm	250 mm / 10"

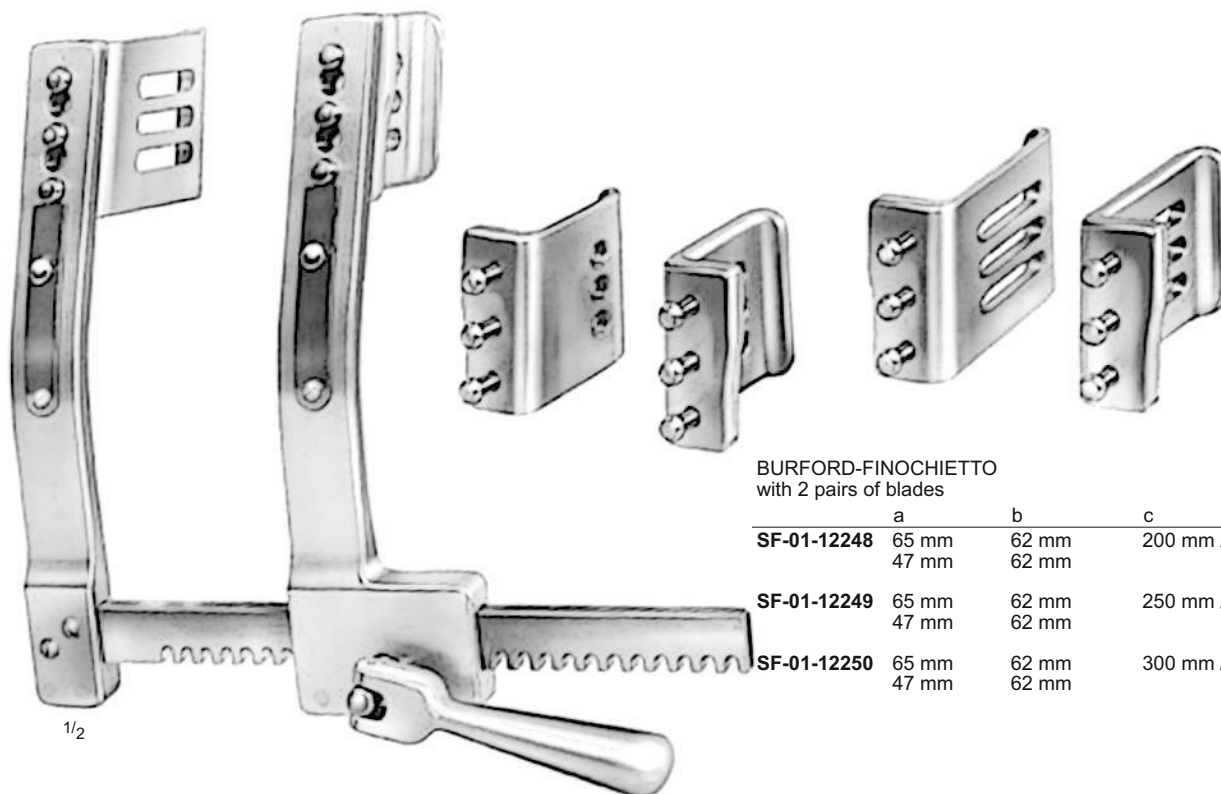

BURFORD-FINOCHIETTO
with 2 pairs of blades

	a	b	c
SF-01-12248	65 mm 47 mm	62 mm 62 mm	200 mm / 8"
SF-01-12249	65 mm 47 mm	62 mm 62 mm	250 mm / 10"
SF-01-12250	65 mm 47 mm	62 mm 62 mm	300 mm / 12"

1/2

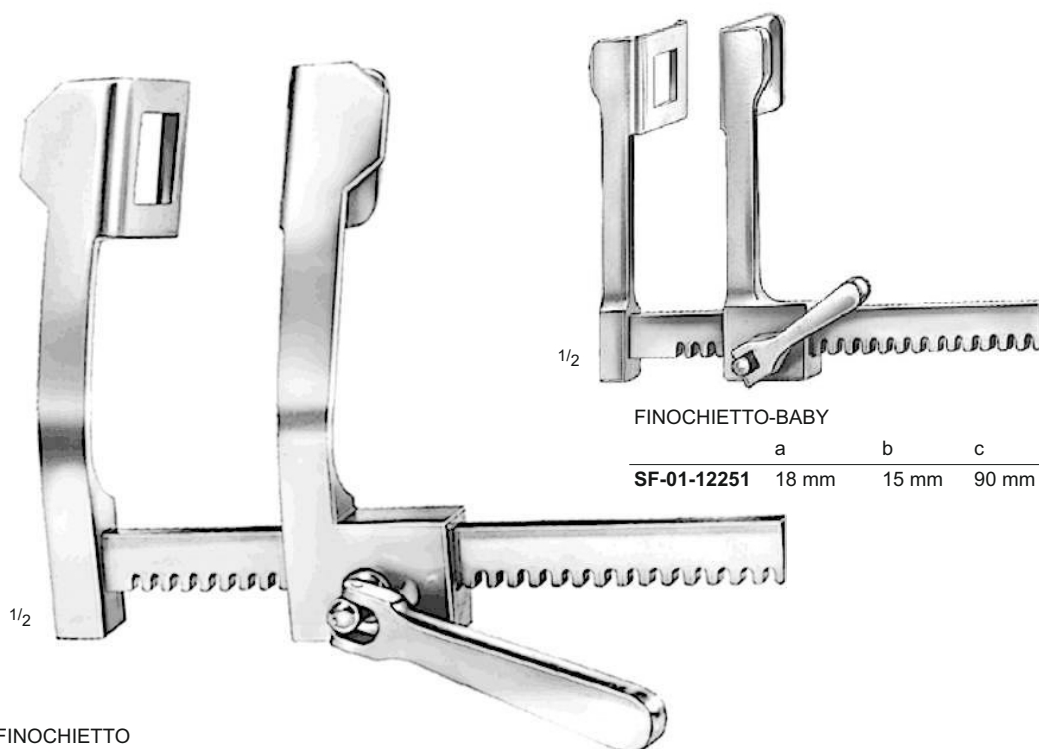

FINOCHIETTO-BABY

	a	b	c
SF-01-12251	18 mm	15 mm	90 mm / 3 1/2"

1/2

FINOCHIETTO

	a	b	c
SF-01-12252	30 mm	45 mm	150 mm / 6"
SF-01-12253	46 mm	62 mm	190 mm / 7 1/2"
SF-01-12254	80 mm	65 mm	190 mm / 7 1/2"



1/2

BAILEY
SF-01-12255
16 cm / 6 1/4"



1/2

BAILEY-GIBBON
SF-01-12256
16 cm / 6 1/4"



1/2

DOYEN
17 cm / 6 1/4"



SF-01-12257



SF-01-12258

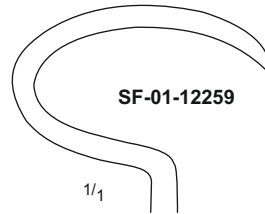

SF-01-12259

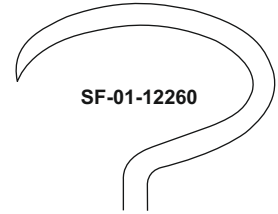

SF-01-12260



ALLISON
SF-01-12261
27 cm / 10 1/4"

SF-01-12262
32 cm / 12 1/2"



50 x 75 mm

DAVIDSON
SF-01-12263

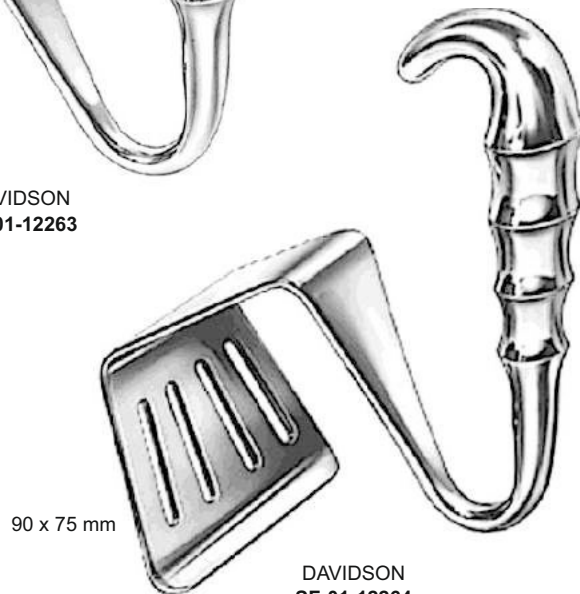

90 x 75 mm

DAVIDSON
SF-01-12264

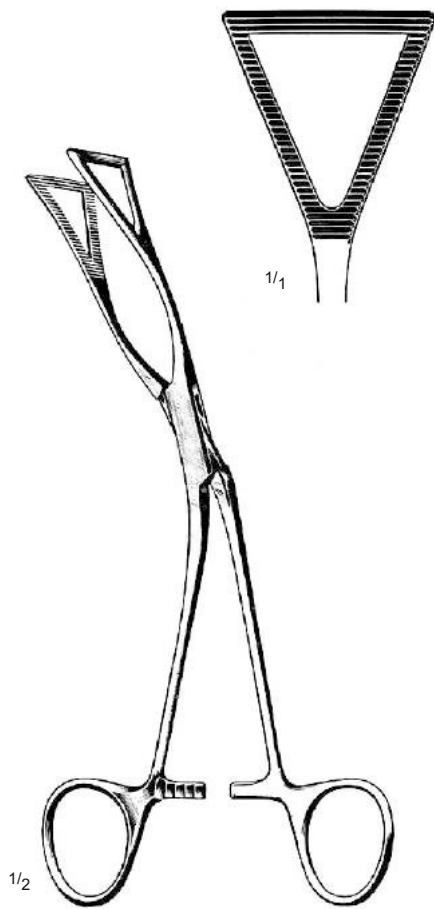

LOVELACE
SF-01-12265
19 cm / 7 1/2"

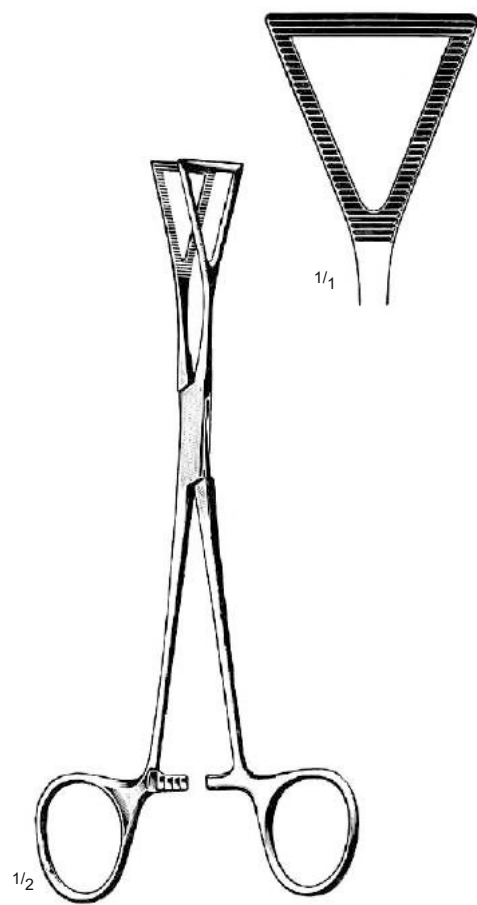

LOVELACE
SF-01-12266
19 cm / 7 1/2"

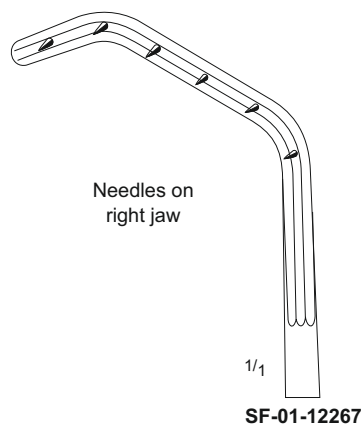
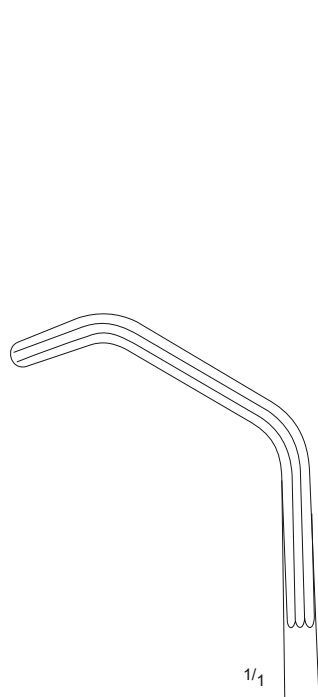

SF-01-12267

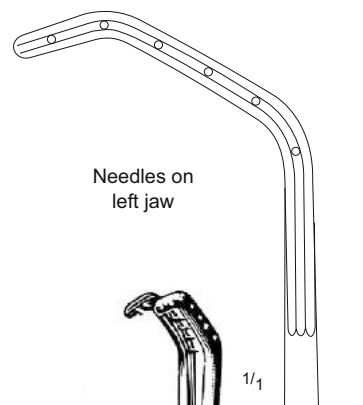

SF-01-12268

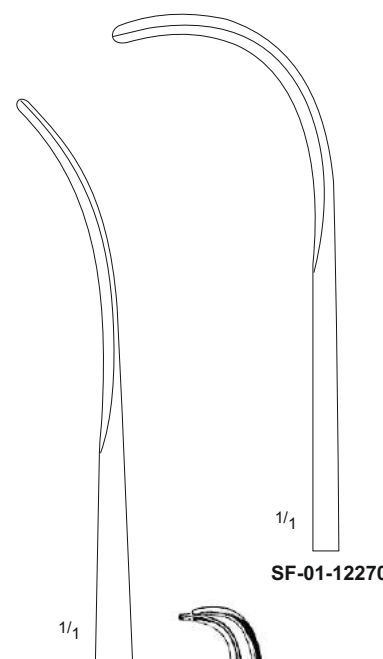

SF-01-12270

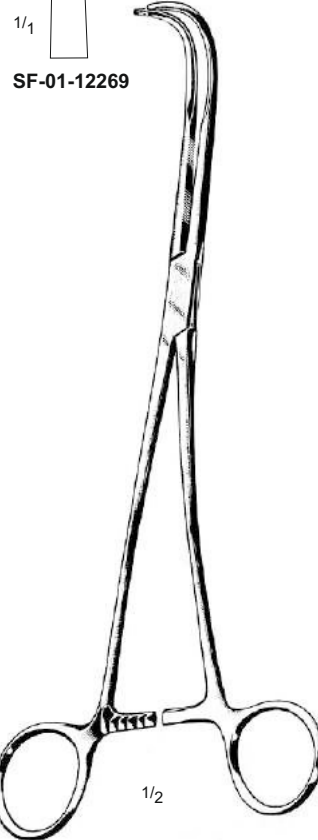

SF-01-12269

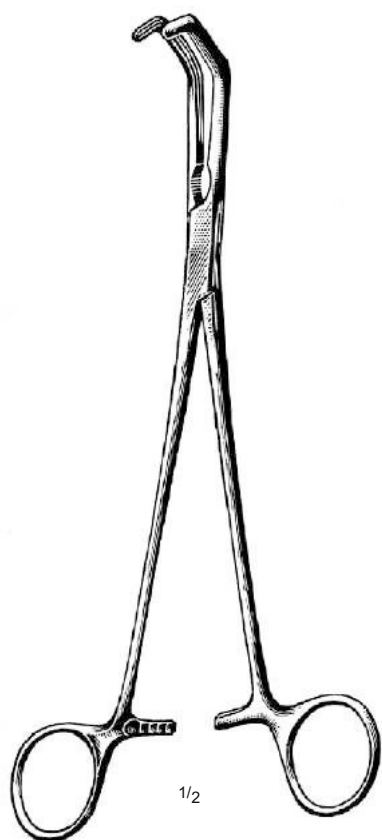

PRICE-THOMAS
SF-01-12271
22 cm / 8 3/4"

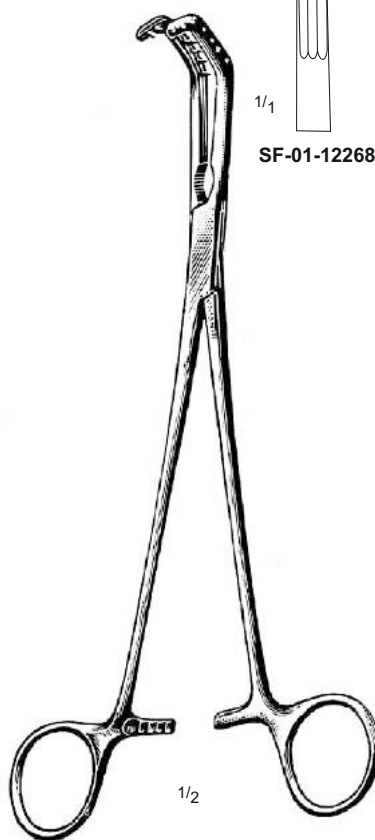

PRICE-THOMAS
22 cm / 8 3/4"

SEMB
24 cm / 9 1/2"

NEUROSURGERY



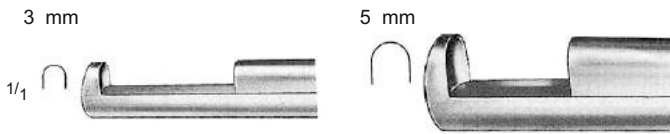

	Length of Shaft	
	15 cm / 6"	20 cm / 8"
Jaws 3 mm wide	SF-01-12272	SF-01-12274
Jaws 5 mm wide	SF-01-12273	SF-01-12275

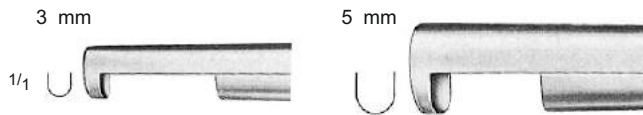
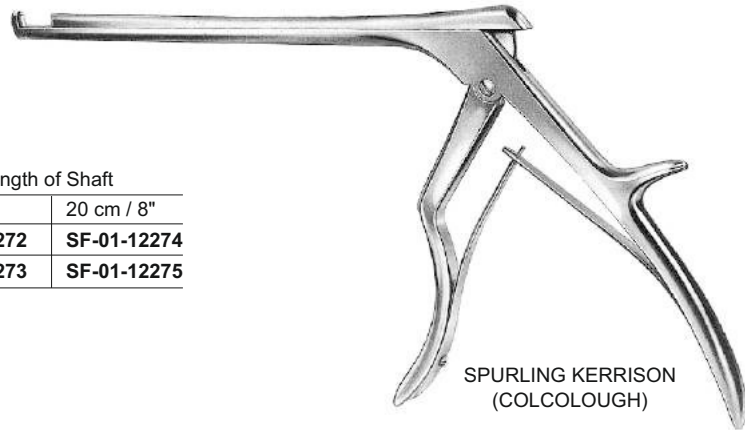

	Length of Shaft	
	15 cm / 6"	20 cm / 8"
Jaws 3 mm wide	SF-01-12276	SF-01-12278
Jaws 5 mm wide	SF-01-12277	SF-01-12279

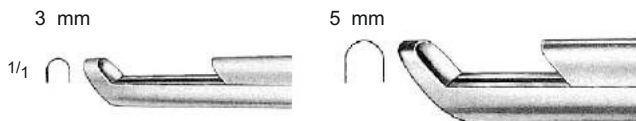
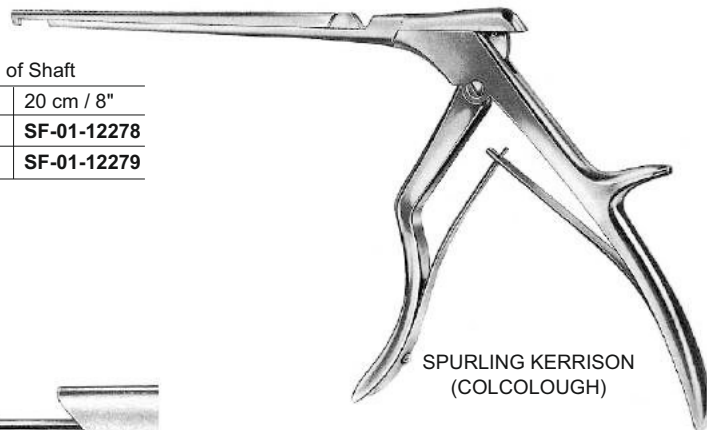



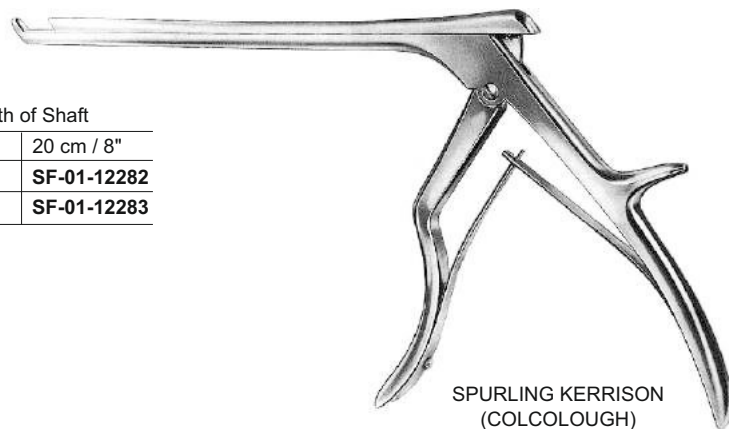

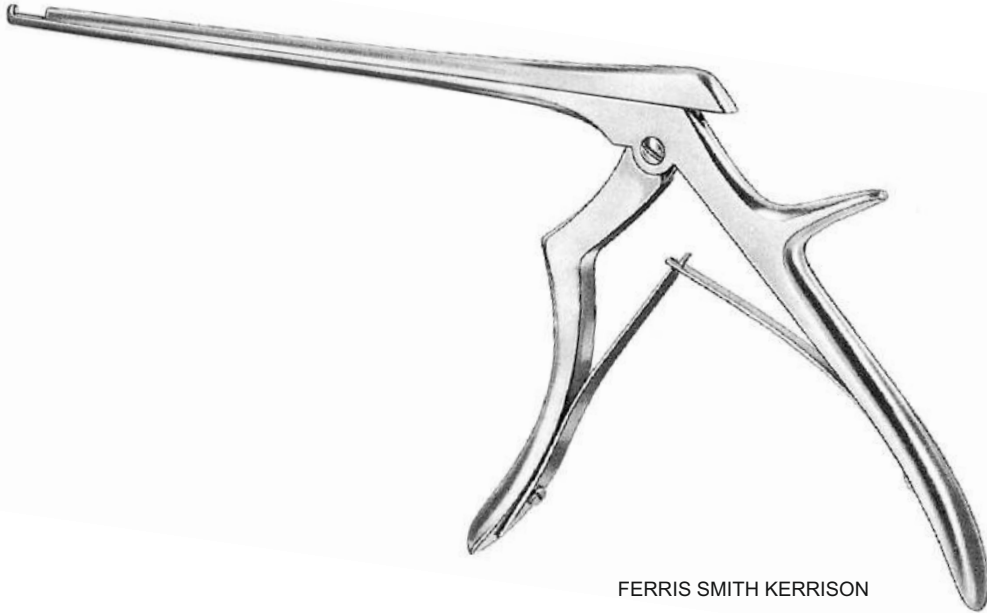

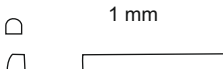
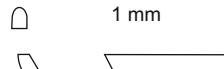

	Length of Shaft	
	15 cm / 6"	20 cm / 8"
Jaws 3 mm wide	SF-01-12280	SF-01-12282
Jaws 5 mm wide	SF-01-12281	SF-01-12283





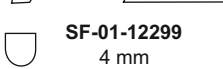

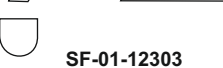
FERRIS SMITH KERRISON

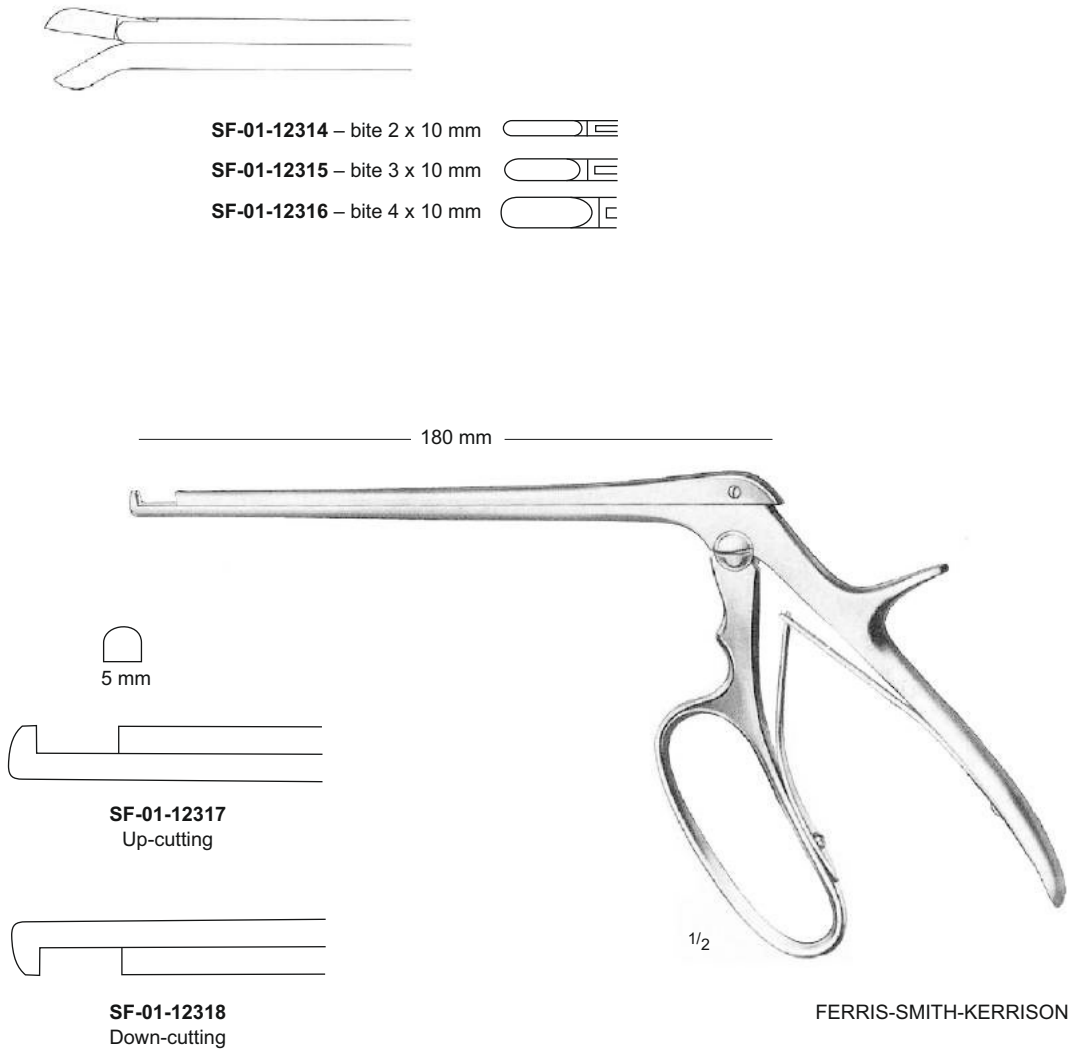
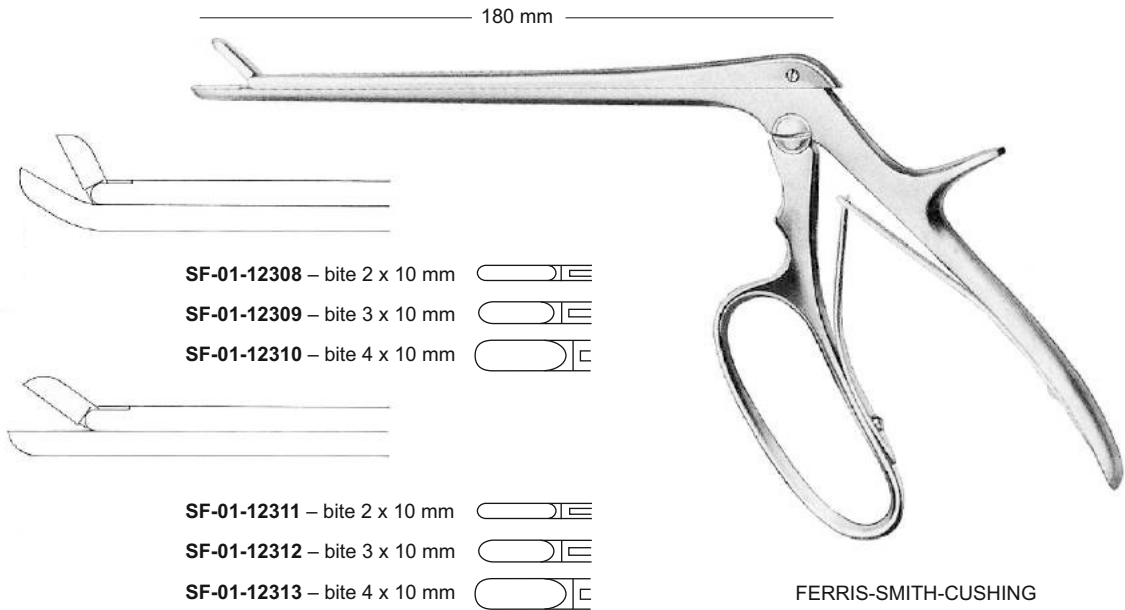
Upwards Cutting	Downwards Cutting	45° Upwards Cutting	45° Downward Cutting
 SF-01-12284 1 mm	 SF-01-12285 1 mm	 SF-01-12286 1 mm	 SF-01-12287 1 mm
 SF-01-12288 2 mm	 SF-01-12289 2 mm	 SF-01-12290 2 mm	 SF-01-12291 2 mm
 SF-01-12292 3 mm	 SF-01-12293 3 mm	 SF-01-12294 3 mm	 SF-01-12295 3 mm
 SF-01-12296 4 mm	 SF-01-12297 4 mm	 SF-01-12298 4 mm	 SF-01-12299 4 mm
 SF-01-12300 5 mm	 SF-01-12301 5 mm	 SF-01-12302 5 mm	 SF-01-12303 5 mm
 SF-01-12304 6 mm	 SF-01-12305 6 mm	 SF-01-12306 6 mm	 SF-01-12307 6 mm

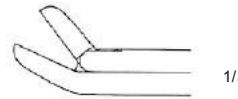
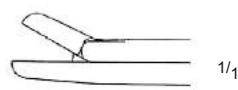
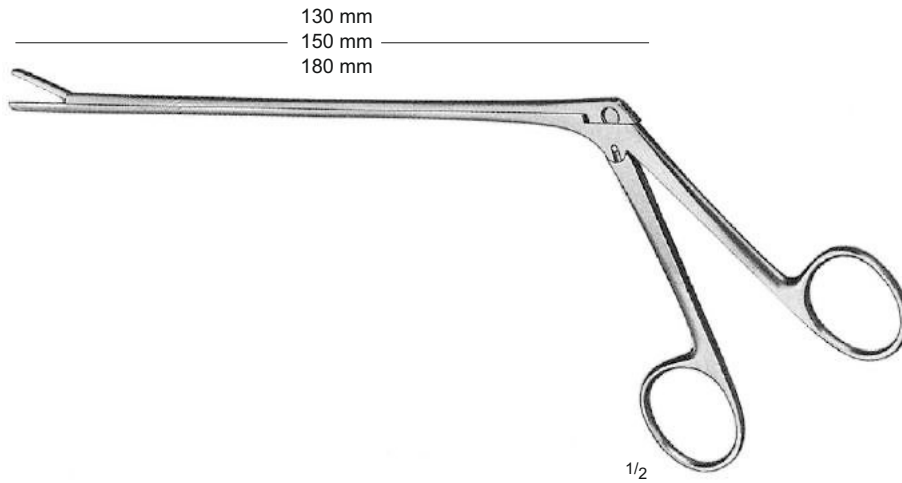

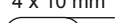

	Shaft Size	Straight	Upward	Downwards
CUSHING 2 x 10 mm 	13.0 cm / 5" 15.0 cm / 6" 18.0 cm / 7"	SF-01-12319 SF-01-12320 SF-01-12321	SF-01-12328 SF-01-12329 SF-01-12330	SF-01-12337 SF-01-12338 SF-01-12339
LOVE-GRUENWALD 3 x 10 mm 	13.0 cm / 5" 15.0 cm / 6" 18.0 cm / 7"	SF-01-12322 SF-01-12323 SF-01-12324	SF-01-12331 SF-01-12332 SF-01-12333	SF-01-12340 SF-01-12341 SF-01-12342
SPURLING 4 x 10 mm 	13.0 cm / 5" 15.0 cm / 6" 18.0 cm / 7"	SF-01-12325 SF-01-12326 SF-01-12327	SF-01-12334 SF-01-12335 SF-01-12336	SF-01-12343 SF-01-12344 SF-01-12345

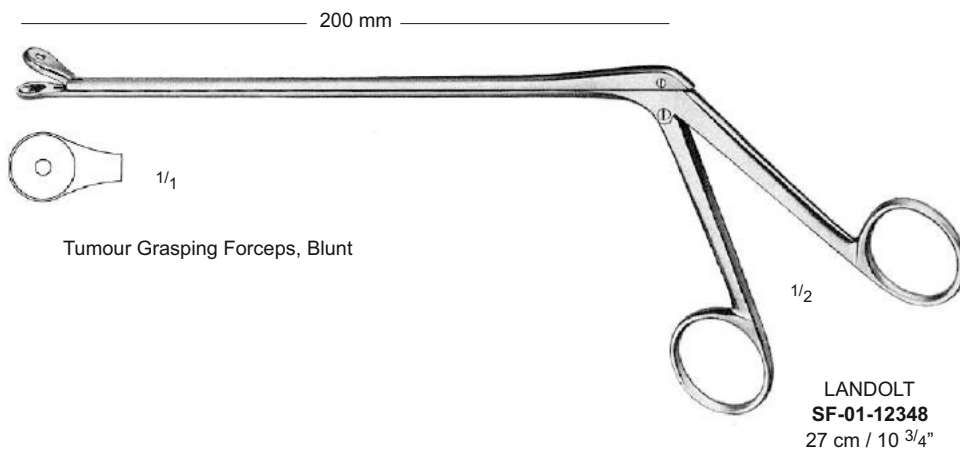
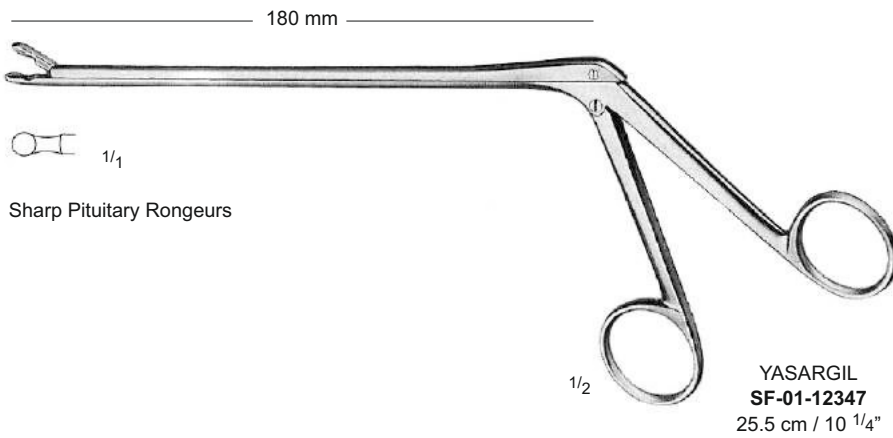
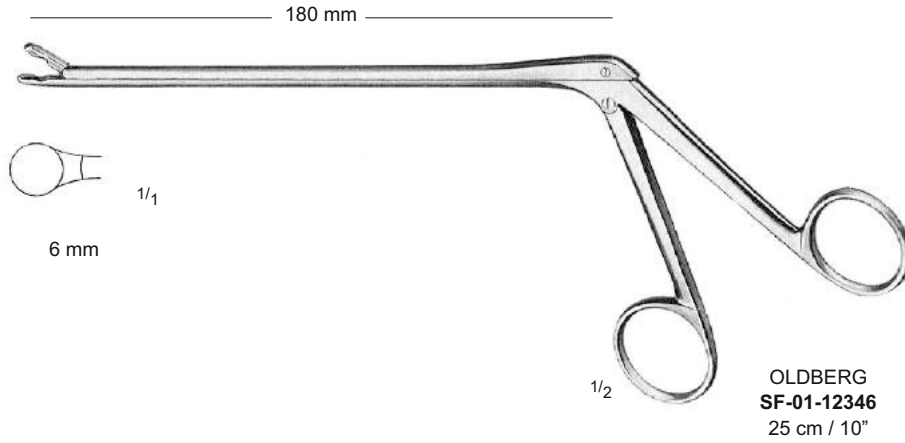

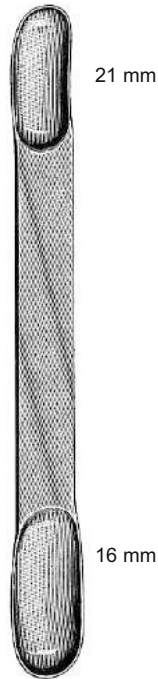

CUSHING
SF-01-12349 – 17 cm / 6³/₄"
SF-01-12350 – 20 cm / 8"

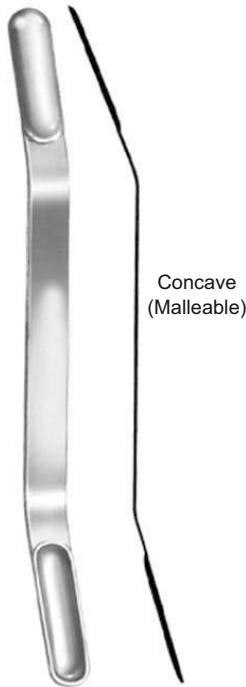

OILVECRONA
18 cm (7 1/8")
SF-01-12351 – 7 + 9 mm
SF-01-12352 – 11 + 13 mm
SF-01-12353 – 15 + 18 mm
SF-01-12354 – 18 + 22 mm

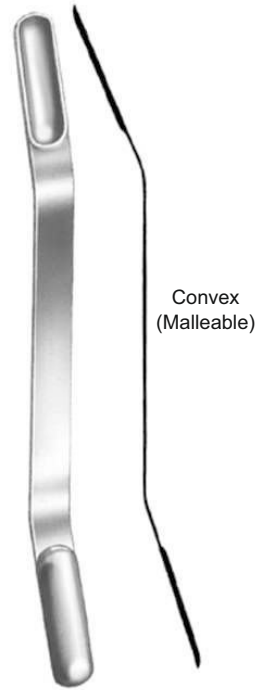

OILVECRONA
18 cm (7 1/8")
SF-01-12355 – 7 + 9 mm
SF-01-12356 – 11 + 13 mm
SF-01-12357 – 15 + 18 mm
SF-01-12358 – 18 + 22 mm



FRAZIER
SF-01-12359
15 cm / 6"



HOEN
SF-01-12360
15 cm / 6"



HOEN
SF-01-12361
15 cm / 6"

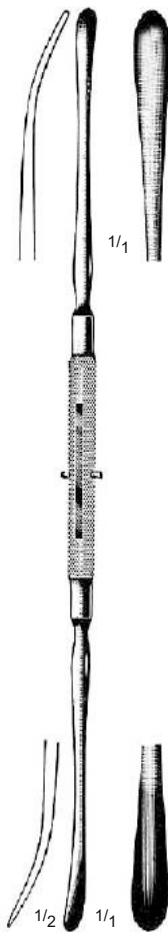

DAVIS
SF-01-12362
24.5 cm / 9 3/4"

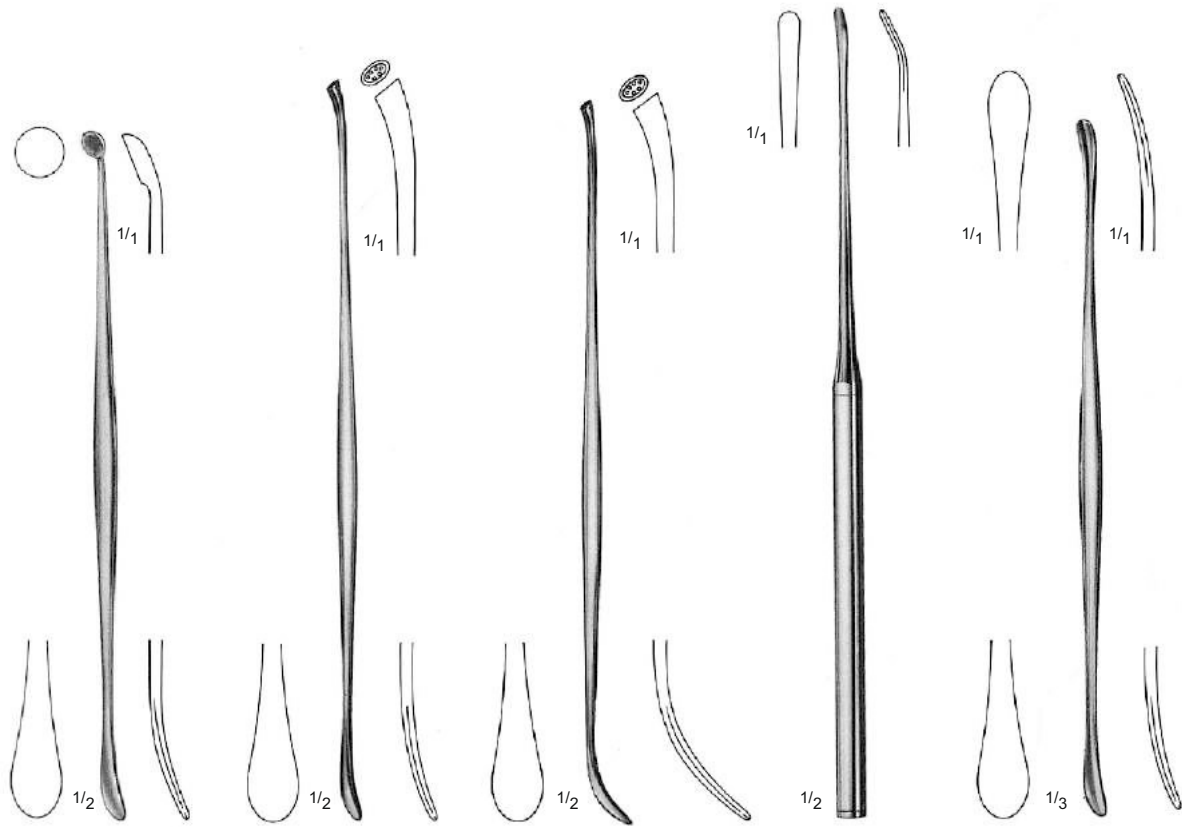

**PENFIELD
SF-01-12363**
Fig. 1
17.5 cm / 7"

**PENFIELD
SF-01-12364**
Fig. 2
19.5 cm / 7 3/4"

**PENFIELD
SF-01-12365**
Fig. 3
19.5 cm / 7 3/4"

**PENFIELD
SF-01-12366**
Fig. 4
21.5 cm / 8 1/2"

**PENFIELD
SF-01-12367**
Fig. 5
29 cm / 11 1/2"



SCOVILLE
SF-01-12368
23 cm / 9"

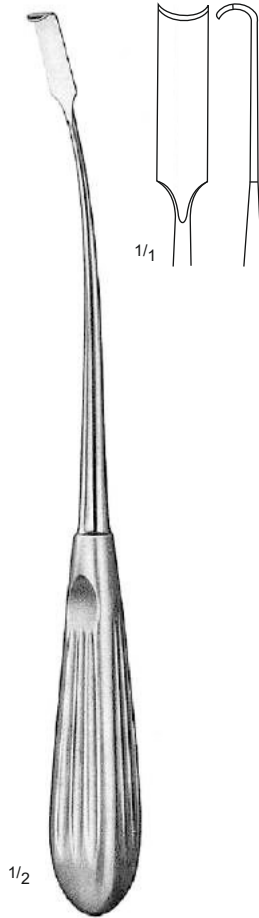

HOLSHER
SF-01-12369
24 cm / 9 1/2"

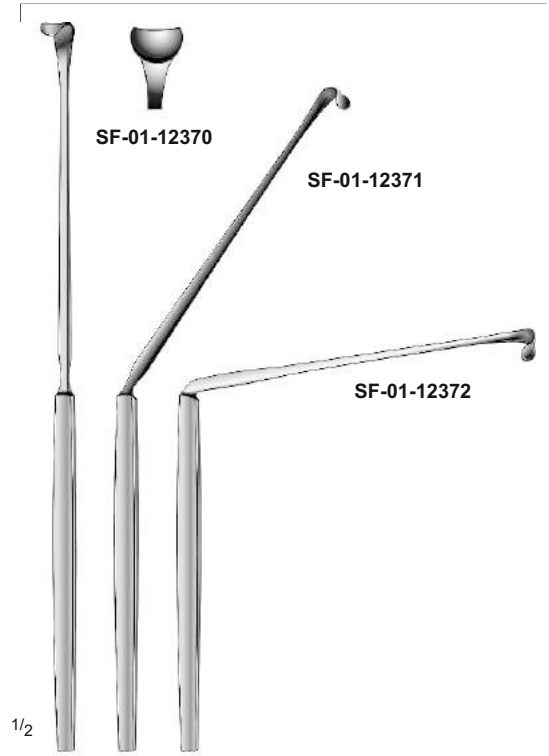

SF-01-12370

SF-01-12371

SF-01-12372

LOVE

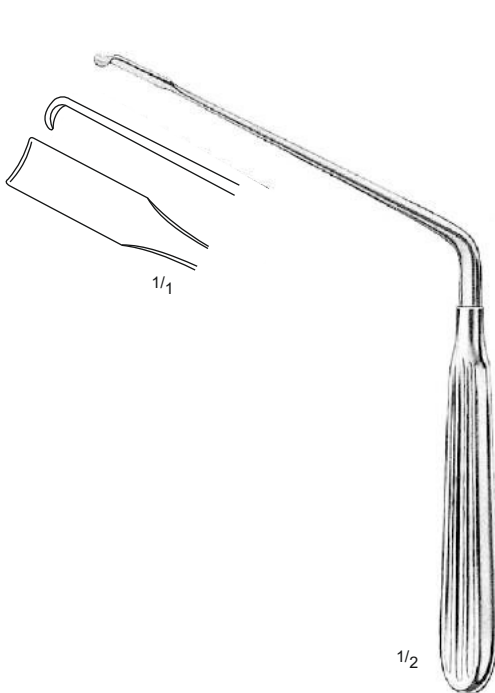

SCOVILLE
SF-01-12373
23 cm / 9"

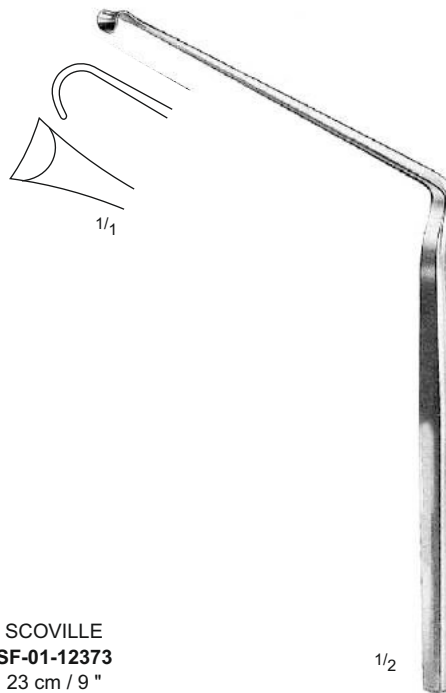

PROFESSIONAL
SF-01-12374
21 cm / 8 1/4"



CLOWARD
SF-01-12375
16 cm / 6 1/4"

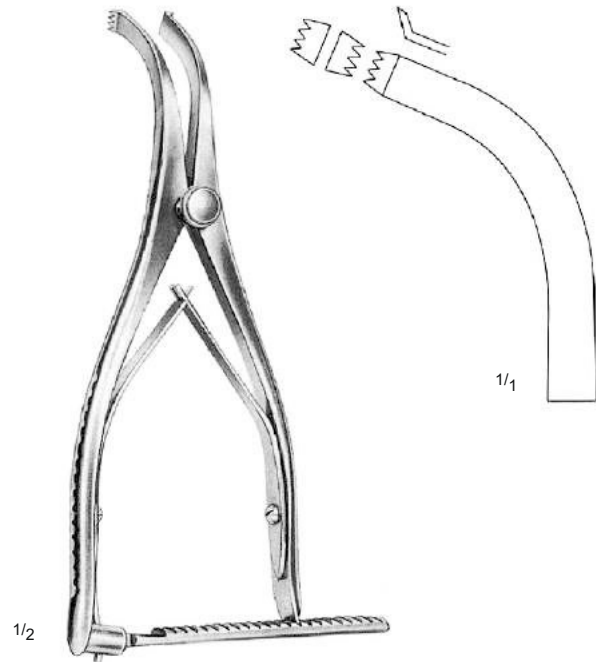

INGE
SF-01-12376
16 cm / 6 1/4"

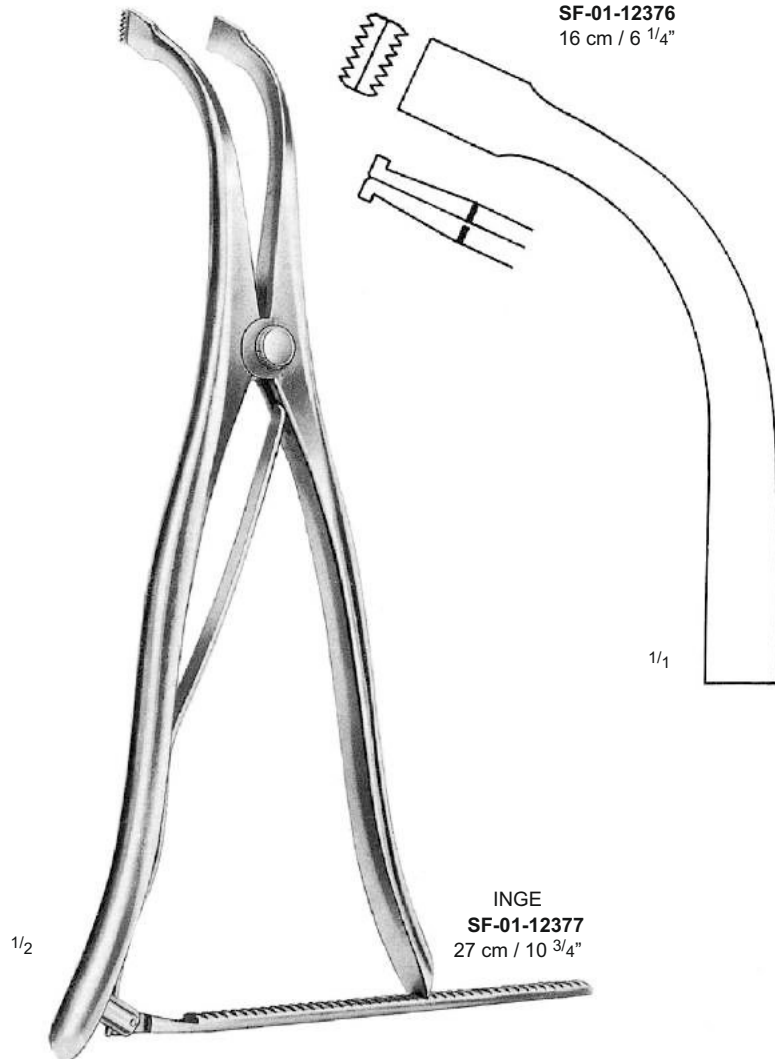

INGE
SF-01-12377
27 cm / 10 3/4"

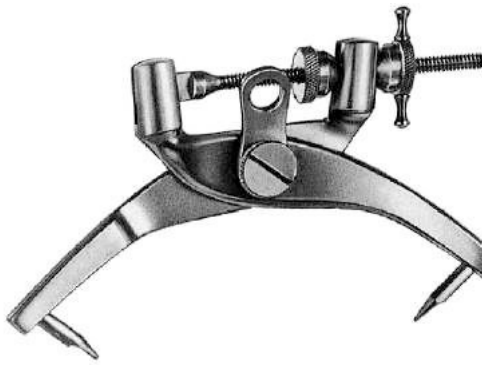

CRUTCHFIELD
SF-01-12378

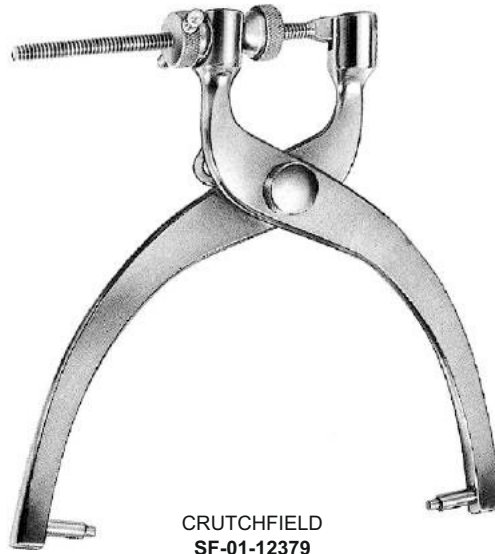

CRUTCHFIELD
SF-01-12379



SF-01-12380
ø 3.5 mm



SF-01-12381
ø 5 mm



EXTENSION PIECE
ONLY
SF-01-12382



SF-01-12383
ø 9 mm



SF-01-12384
ø 14 mm



SF-01-12385
ø 16 mm



SF-01-12386
ø 22 mm



BRACE ONLY
SF-01-12387

HUDSON
Cranial Drill
Complete with 4
burs No.,



CUSHING
SF-01-12388
ø 13 mm



McKENZIE
SF-01-12389
ø 13 mm



D'ERRICO
SF-01-12390
ø 16 mm

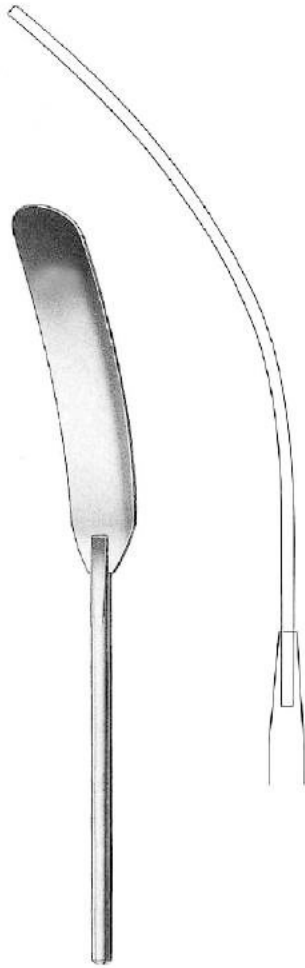

HEIFETZ
20 cm / 8"

- SF-01-12391 8 mm
- SF-01-12392 11 mm
- SF-01-12393 14 mm
- SF-01-12394 17 mm
- SF-01-12395 20 mm

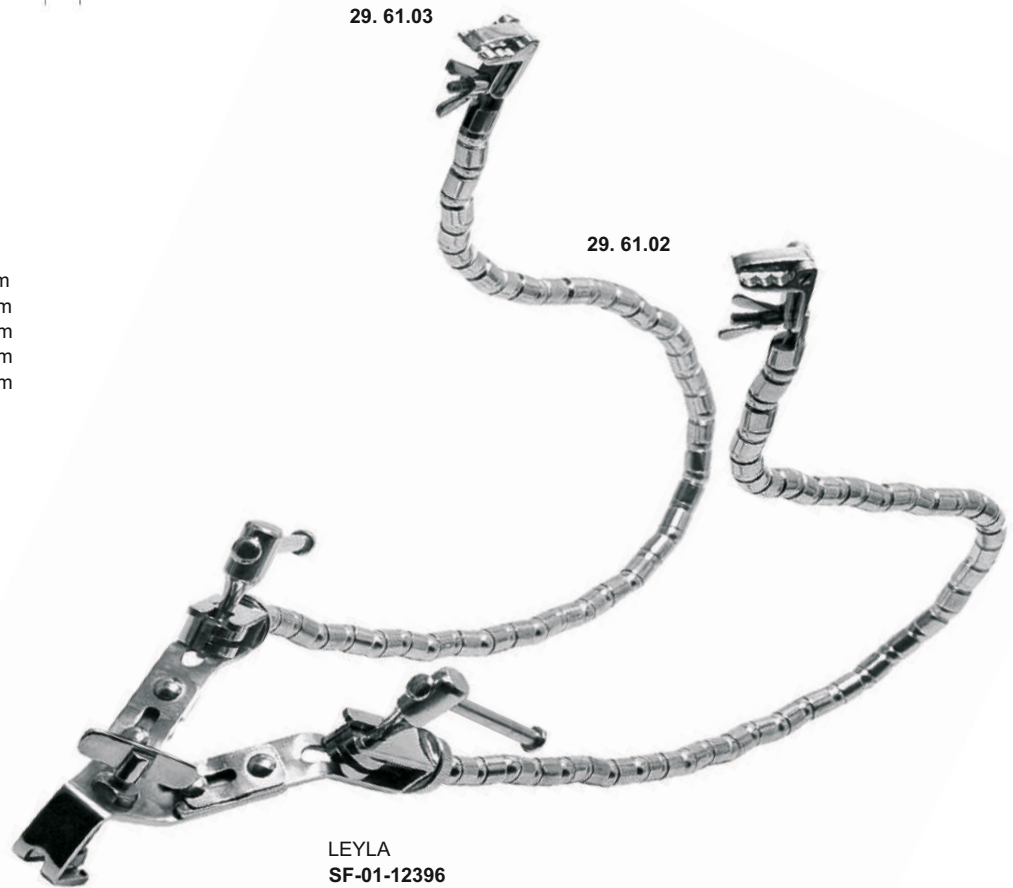

LEYLA

SF-01-12396

Complete with two flexible arms
one fixation base and two clamps
for holding brain spatulas

UROLOGY Instruments





VAN BUREN
27.5 cm / 11"
Charrier (French)
No. (8-30)

CHARRIERE
(French)

VAN BUREN	GUYON
SF-01-12397 8	-
SF-01-12398 10	SF-01-12410
	11 SF-01-12411
SF-01-12399 12	SF-01-12412
	13 SF-01-12413
SF-01-12400 14	SF-01-12414
	15 SF-01-12415
SF-01-12401 16	SF-01-12416
	17 SF-01-12417
SF-01-12402 18	SF-01-12418
	19 SF-01-12419
SF-01-12403 20	SF-01-12420
	21 SF-01-12421
SF-01-12404 22	SF-01-12422
	23 SF-01-12423
SF-01-12405 24	SF-01-12424
	25 SF-01-12425
SF-01-12406 26	SF-01-12426
	27 SF-01-12427
SF-01-12407 28	SF-01-12428
	29 SF-01-12429
SF-01-12408 30	SF-01-12430
SF-01-12409 (Set of 12, pcs)	SF-01-12431 (Set 21, pcs)

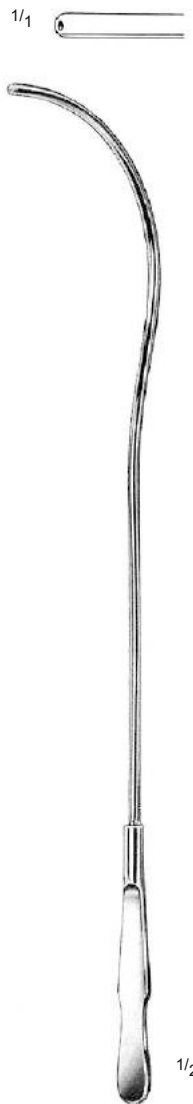

GUYON
27.5 cm / 11"
Charrier (French)
No. (14. 30)



Charriere
(French)
SF-01-12432 - 6
SF-01-12433 - 8
SF-01-12434 - 10
SF-01-12435 - 12
SF-01-12436 - 13
SF-01-12437 - 14
SF-01-12438 - 15
SF-01-12439 - 16
Charrier (French)
No. 6-16,
16 cm / 6 1/4"



GUYON
SF-01-12440
36 cm / 14 1/4"



GUYON
SF-01-12441
36 cm / 14 1/4"



DITTEL
SF-01-12442
39 cm / 15 1/2"



SF-01-12443
39 cm / 15 1/2"



35 mm

LEGUEU
SF-01-12444
27 cm / 10 1/2"

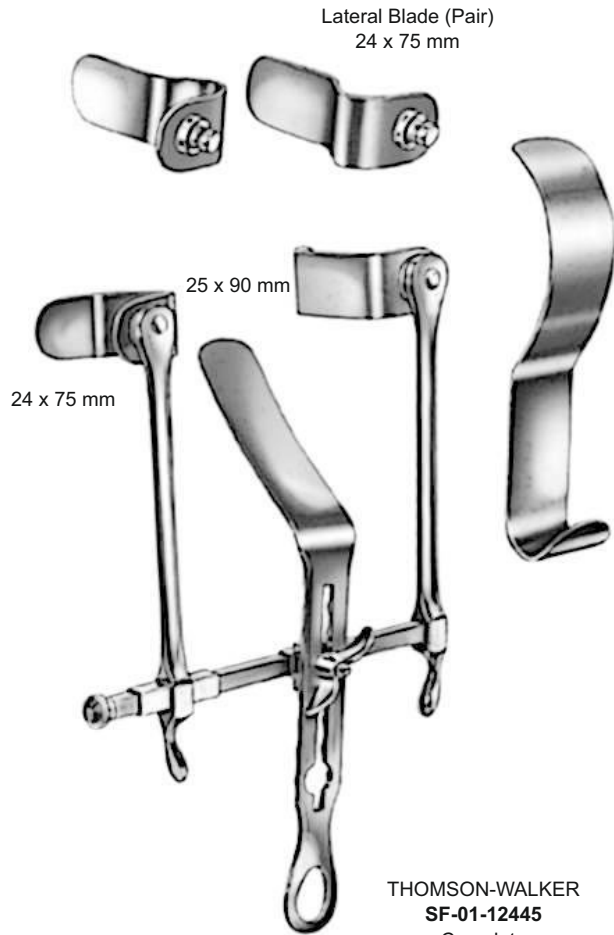

Lateral Blade (Pair)
24 x 75 mm

25 x 90 mm

24 x 75 mm

THOMSON-WALKER
SF-01-12445
Complete

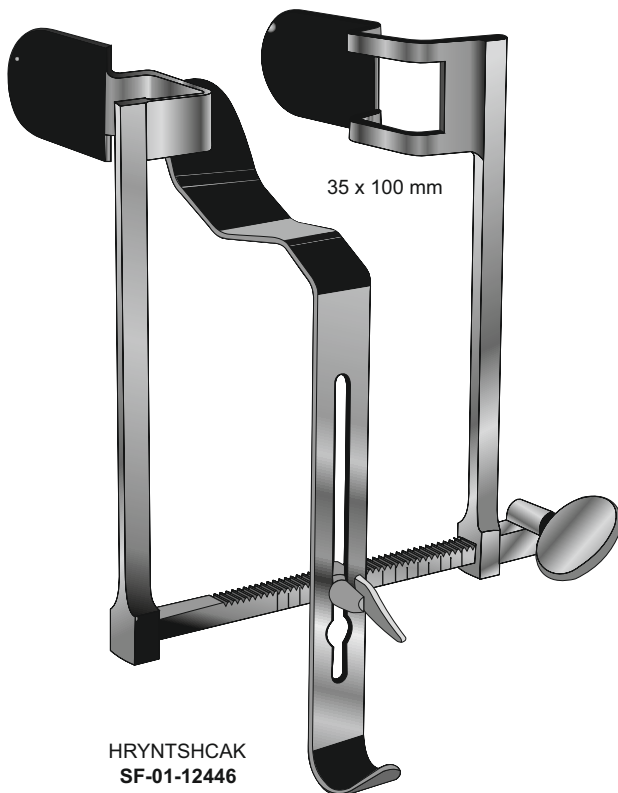

35 x 100 mm

HRYNTSHCAK
SF-01-12446

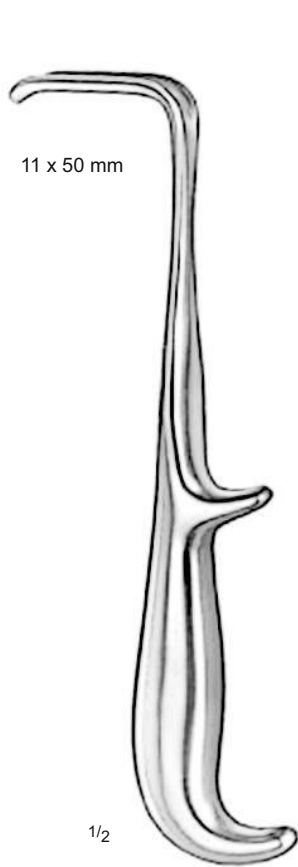

YOUNG
SF-01-12447
21 cm / 8 1/4"



YOUNG
SF-01-12448
22 cm / 8 3/4"



YOUNG
SF-01-12449
21 cm / 8 1/4"

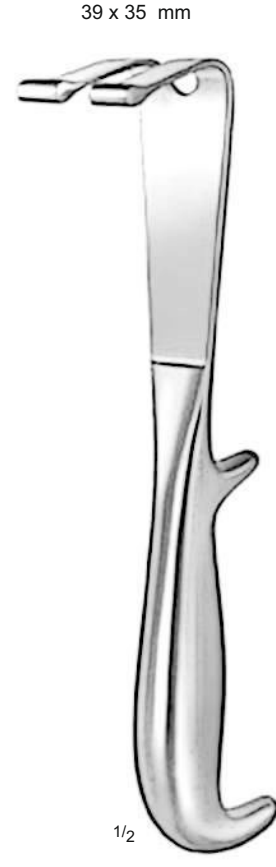

YOUNG
SF-01-12450
22 cm / 8 3/4"

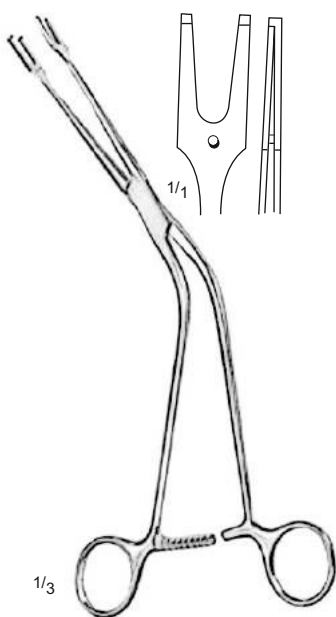

MILLIN
SF-01-12451
24 cm / 9 1/2"

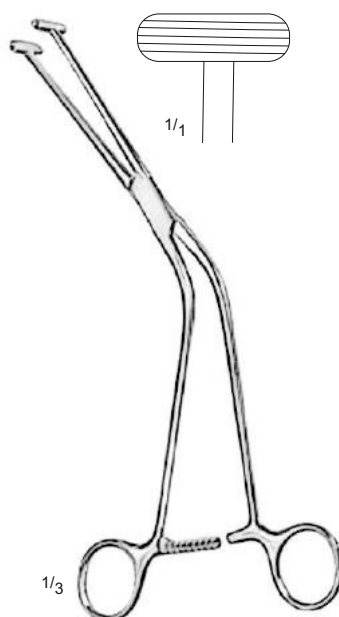

MILLIN
SF-01-12452
23 cm / 9"



MILLIN
SF-01-12453
23 cm / 9"

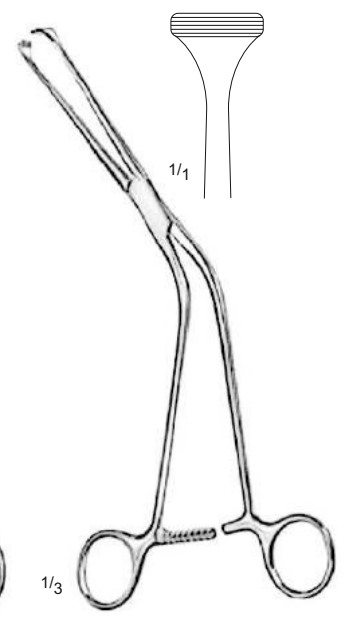

MILLIN
SF-01-12454
23 cm / 9"



1/2

MILLIN
SF-01-12455
28 cm / 11"



1/2

STRAUSS
SF-01-12456
12 cm / 4 3/4"



1/2

STOCKMANN
SF-01-12457
8 cm / 3 1/8"

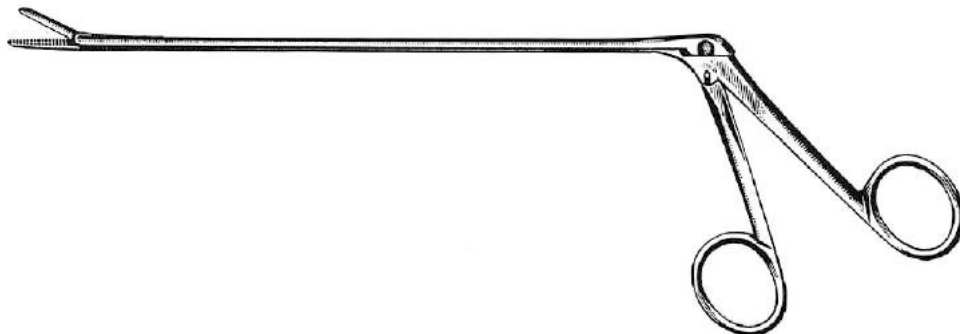

MATHIEU
SF-01-12458 – 20 cm / 8"
SF-01-12459 – 28 cm / 11"

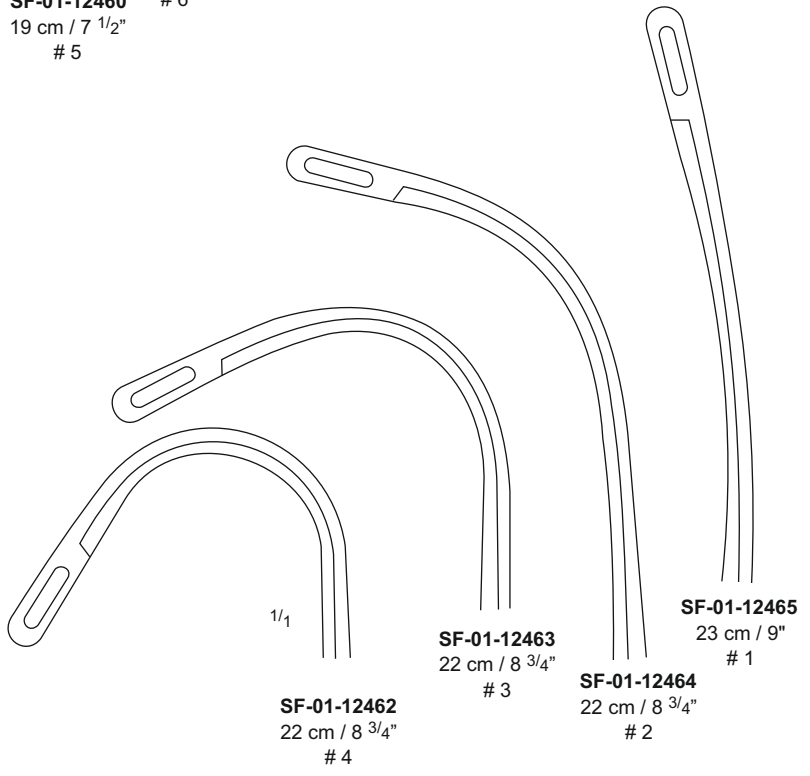
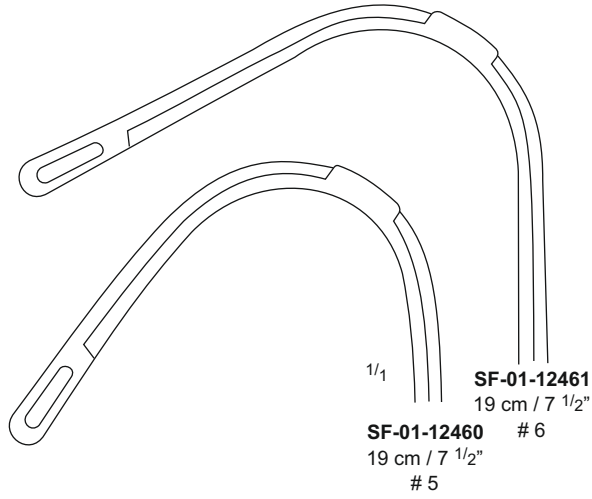

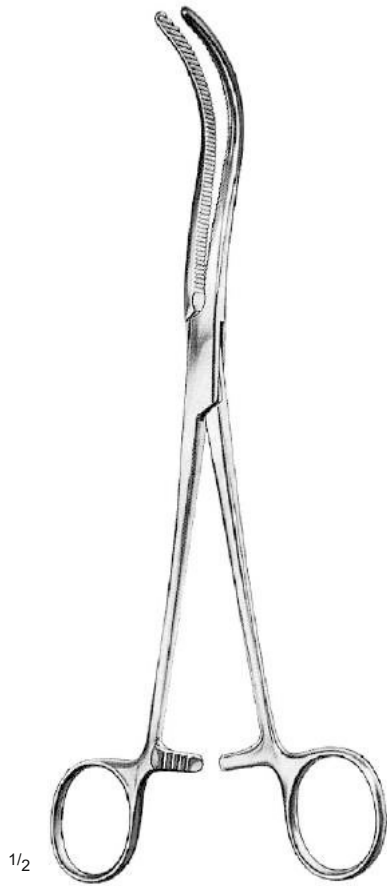

GUYON

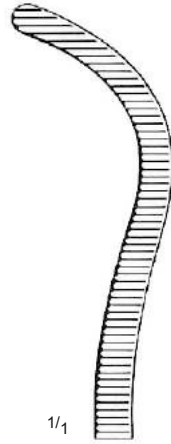

SF-01-12466
20 cm / 8"

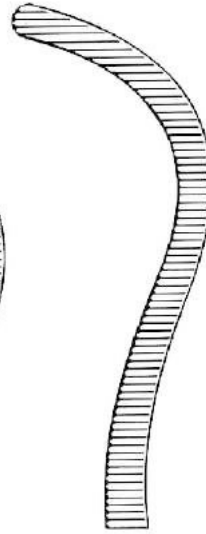

SF-01-12467
22 cm / 8 3/4"

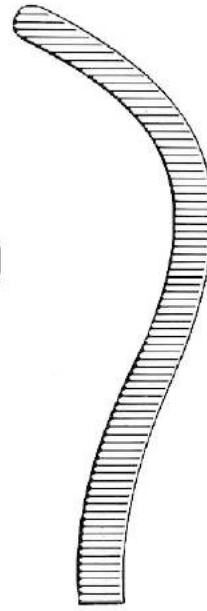

SF-01-12468
24 cm / 9 1/2"

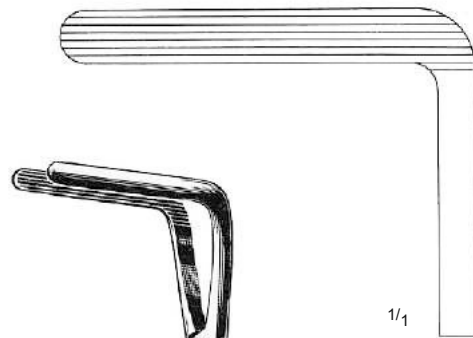

WERTHEIM-CULLEN
SF-01-12469
23 cm / 9"

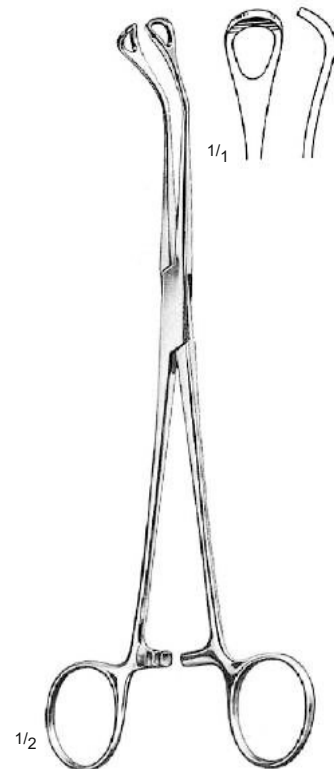
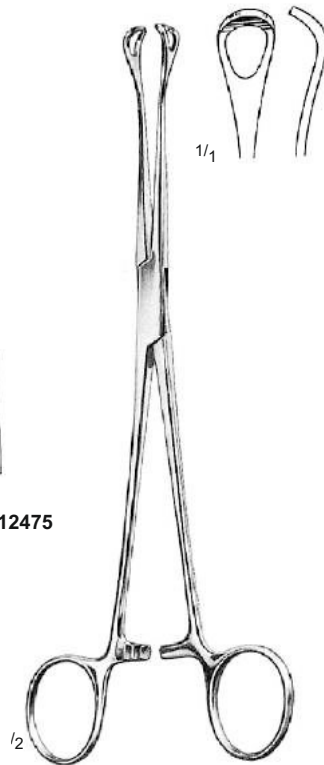
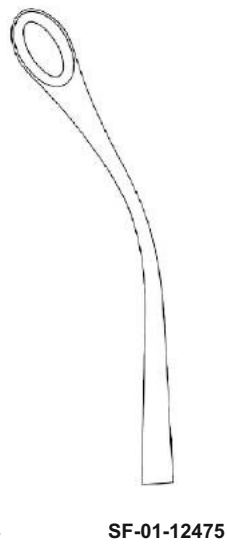
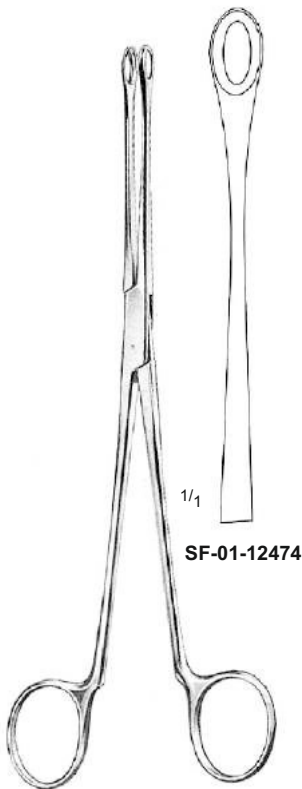
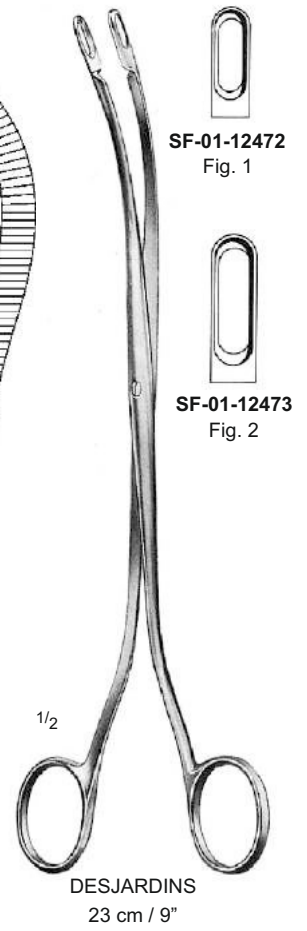
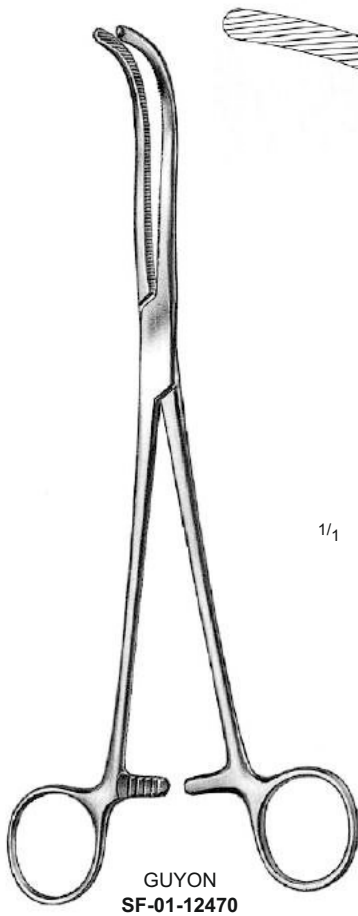

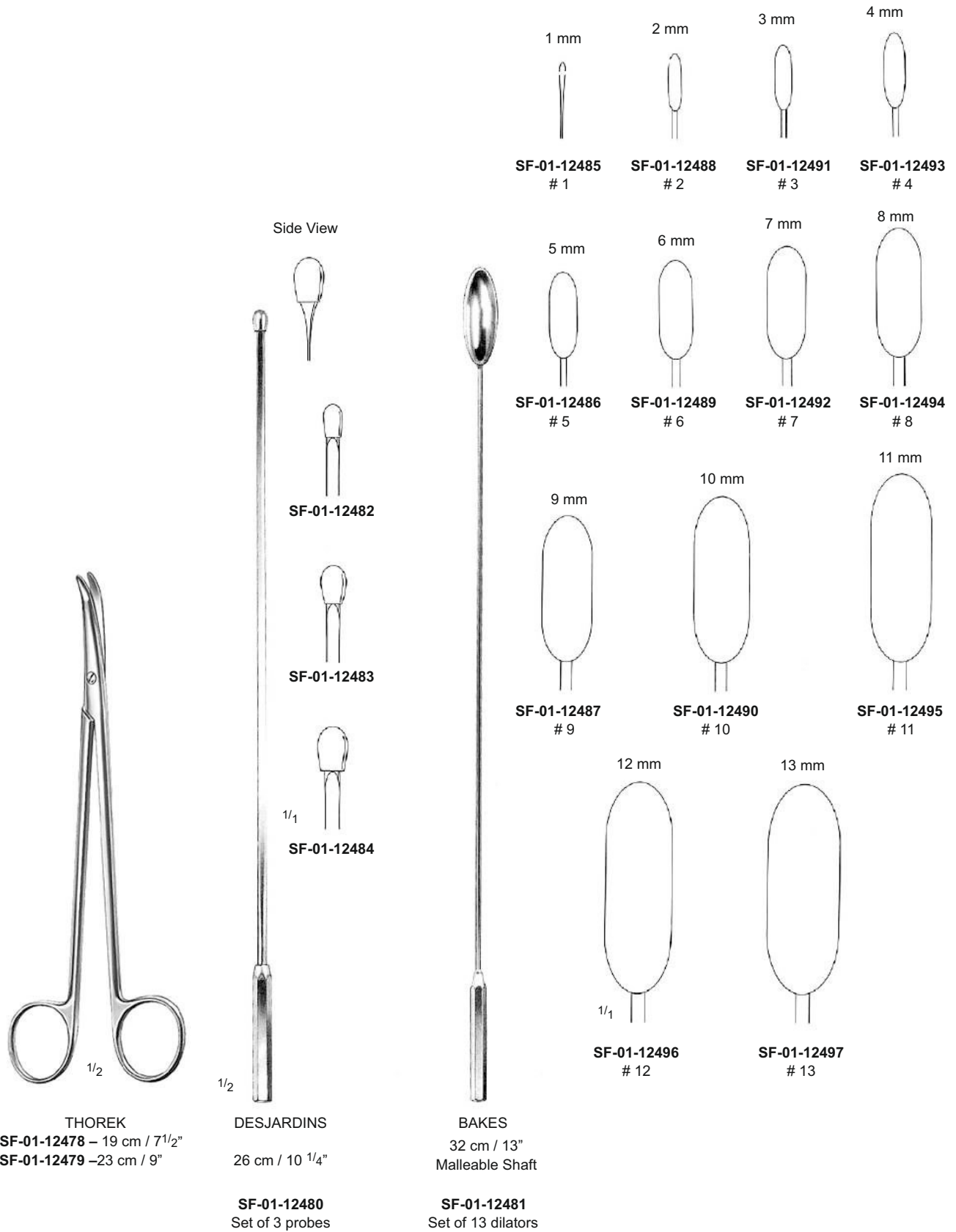

NASAL Instruments





KRAUS
SF-01-12498
26 cm / 10 1/4"

KRAUS VOSS
SF-01-12499
26 cm / 10 1/4"

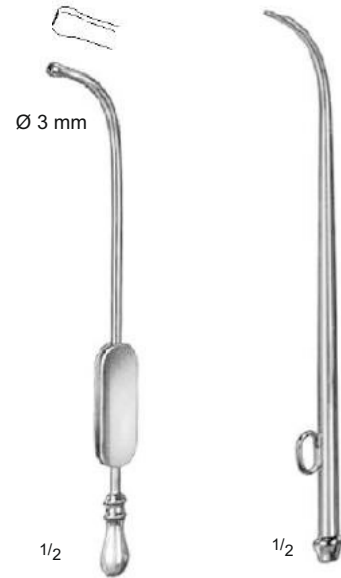

EICKEN-KILLIAN
SF-01-12503
14 cm / 5 1/2"

SIEBENMANN
SF-01-12504 = ø 1.5 mm
SF-01-12505 = ø 1.7 mm
SF-01-12506 = ø 2.0 mm
SF-01-12507 = ø 2.5 mm
SF-01-12508 = ø 3.0 mm



SF-01-12500 – 0.3 mm ø
SF-01-12501 – 0.4 mm ø
Coil / 10 metre



SF-01-12502
0.3 mm ø
Package / 100

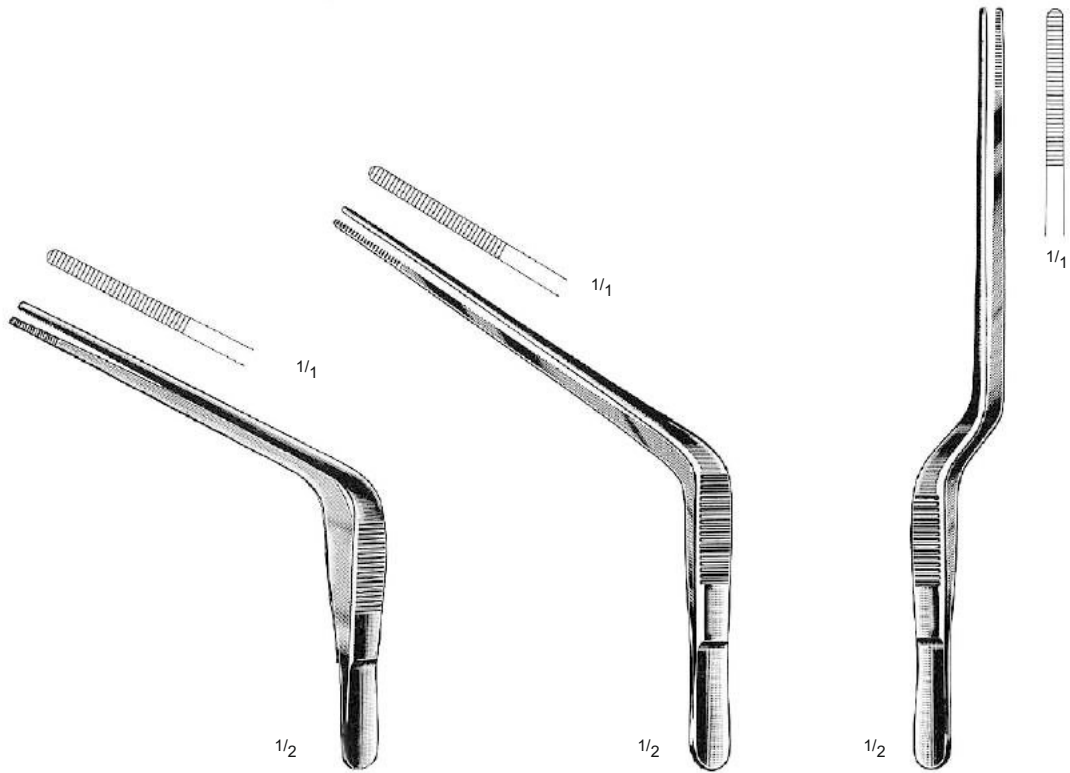

TROELTSCH
SF-01-12509
15 cm / 6"

TROELTSCH
SF-01-12510
18 cm / 7"

GRUENWALD (JANSEN)
SF-01-12511
20 cm / 8"

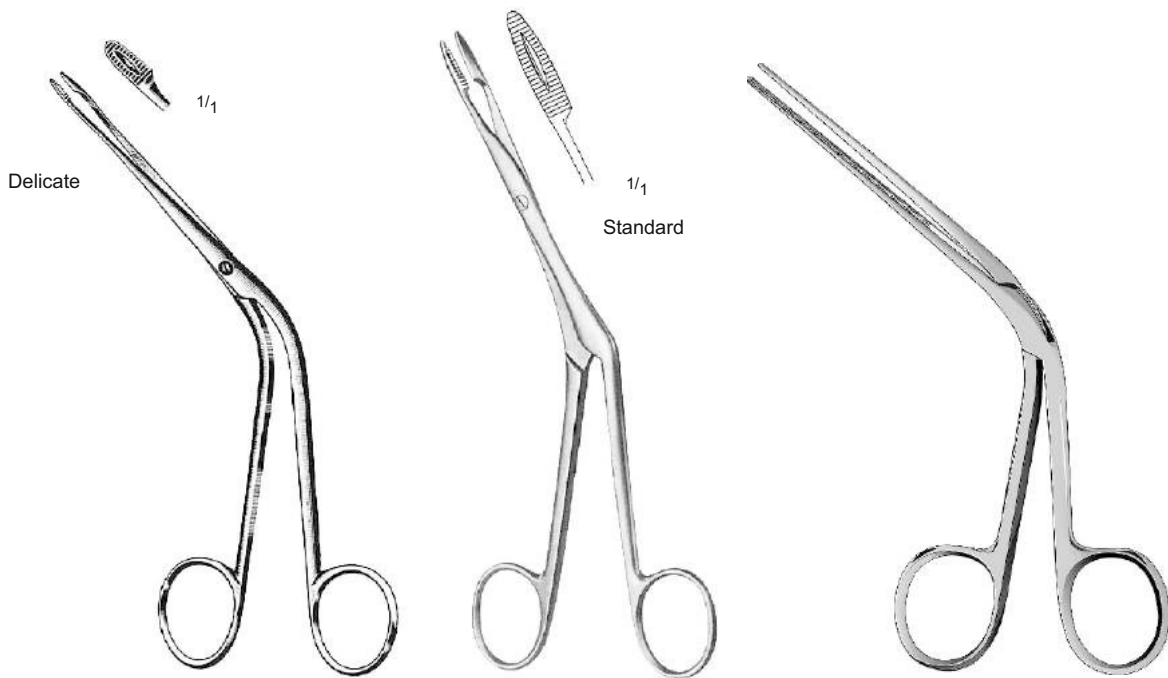

Delicate

Standard

HARTMANN
SF-01-12512
16 cm / 6 1/4"

HARTMANN
SF-01-12513
20 cm / 8"

TILLEY
SF-01-12514
17 cm / 6 3/4"



PROFESSIONAL
SF-01-12515
13 cm / 5"



Pediatric



PROFESSIONAL
SF-01-12516
13 cm / 5"



Pediatric



TIECK-HALLE
13.5 cm / 5 1/4"

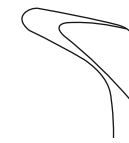

SF-01-12517



SF-01-12518

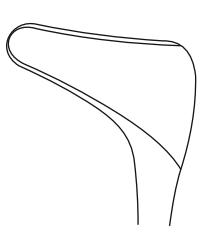

SF-01-12519

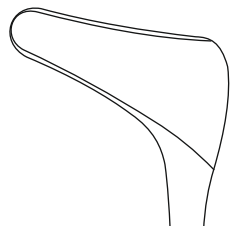

SF-01-12520

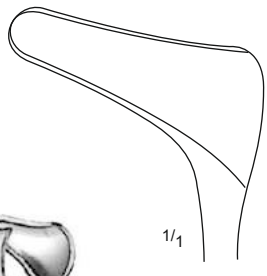

SF-01-12521



HARTMANN-HALLE
15 cm / 6"



SF-01-12525
4

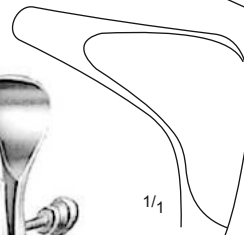

SF-01-12524
3

SF-01-12523
2

SF-01-12522
1



COTTLE
15 cm / 6"

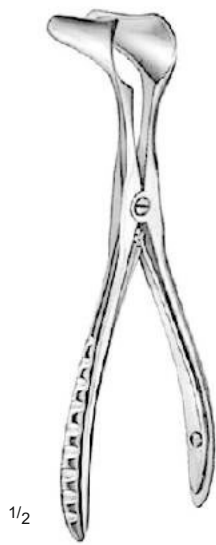

KILLIAN
14 cm / 5 1/2"

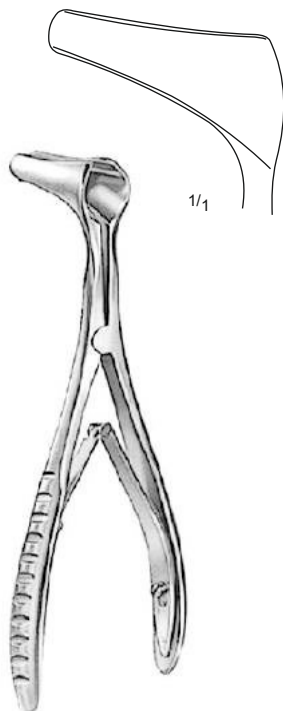
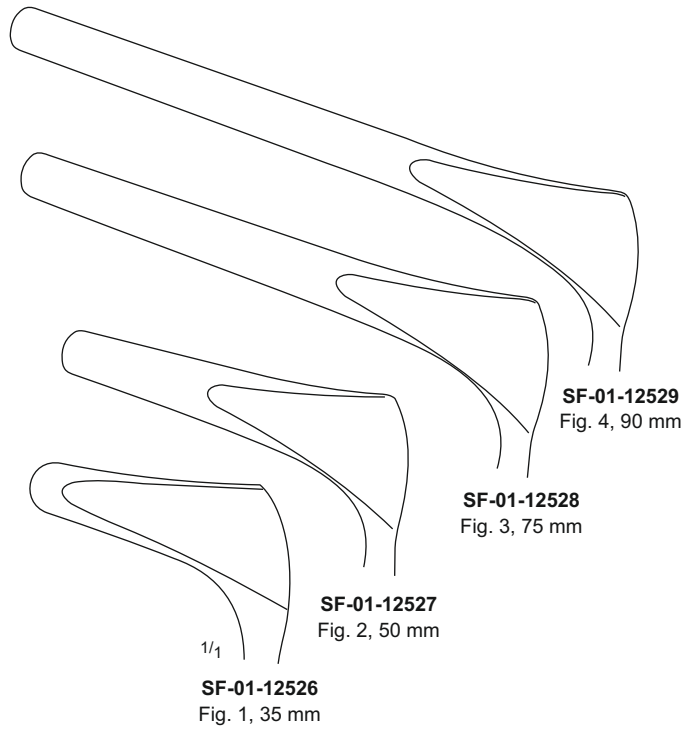

VIENNA PATTERN
SF-01-12533
15 cm / 6"

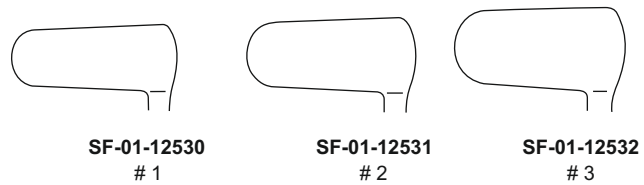

GOLDSMITH (THUDICUM)
6.5 cm / 2 1/2"

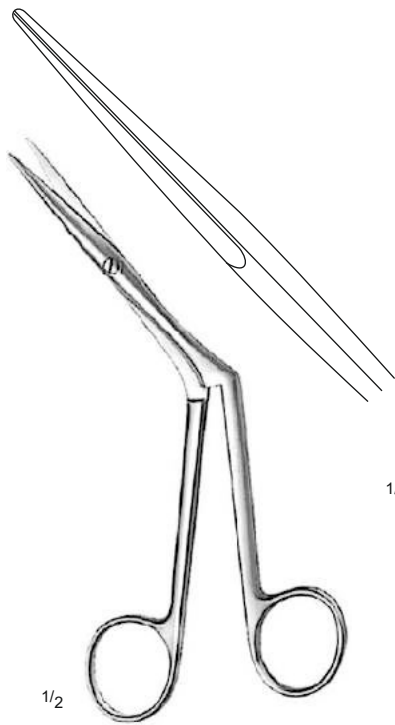

HEYMANN-KNIGHT
SF-01-12534
18 cm / 7"

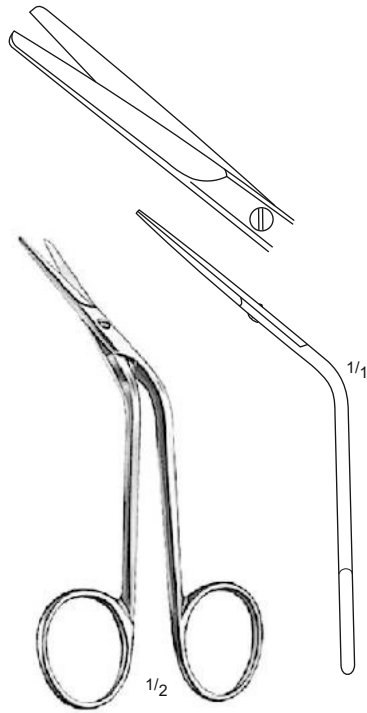

FOMON
SF-01-12535
15 cm / 6"

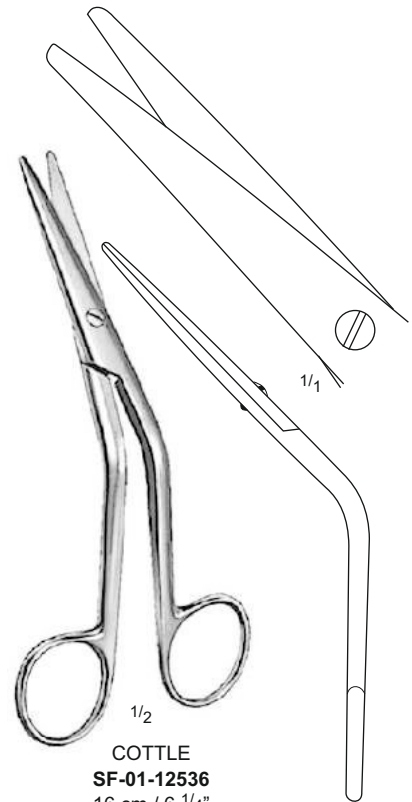

COTTLE
SF-01-12536
16 cm / 6 1/4"



BLALENGER
20 cm / 8"

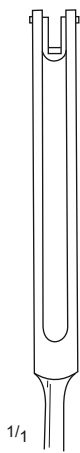

SF-01-12537
3.0 mm

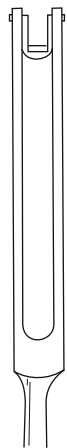

SF-01-12538
4.0 mm



SF-01-12539
5.0 mm

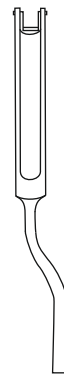

BLALENGER
Bayonet Shape
SF-01-12540
20 cm / 8"

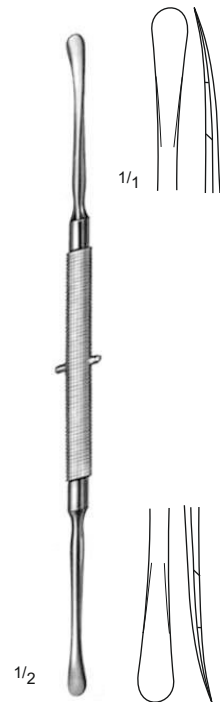

FREER
SF-01-12541
21 cm / 8 1/4"

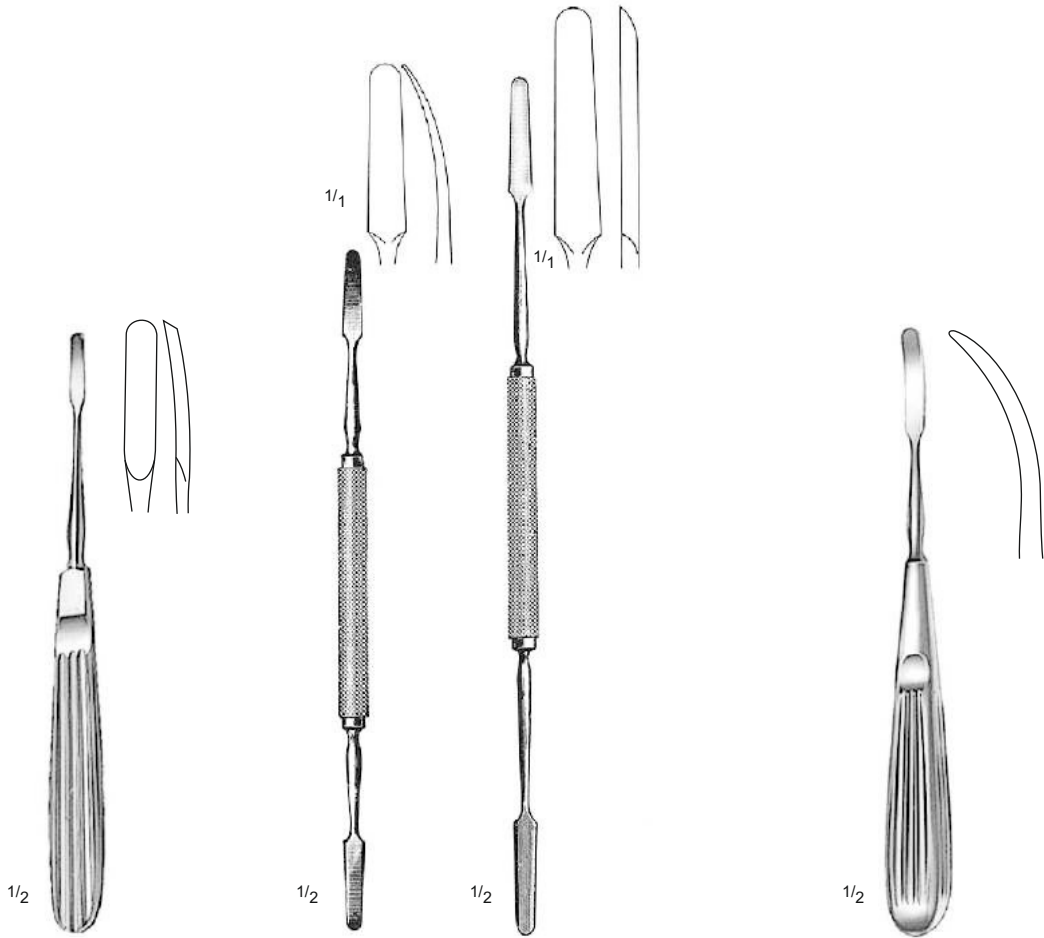

JOSEPH
SF-01-12542
16 cm / 6 1/4"

KILLIAN
SF-01-12543
18 cm / 7"

KILLIAN
SF-01-12544
22 cm / 8 3/4"

JOSEPH
SF-01-12545
16 cm / 6 1/4"

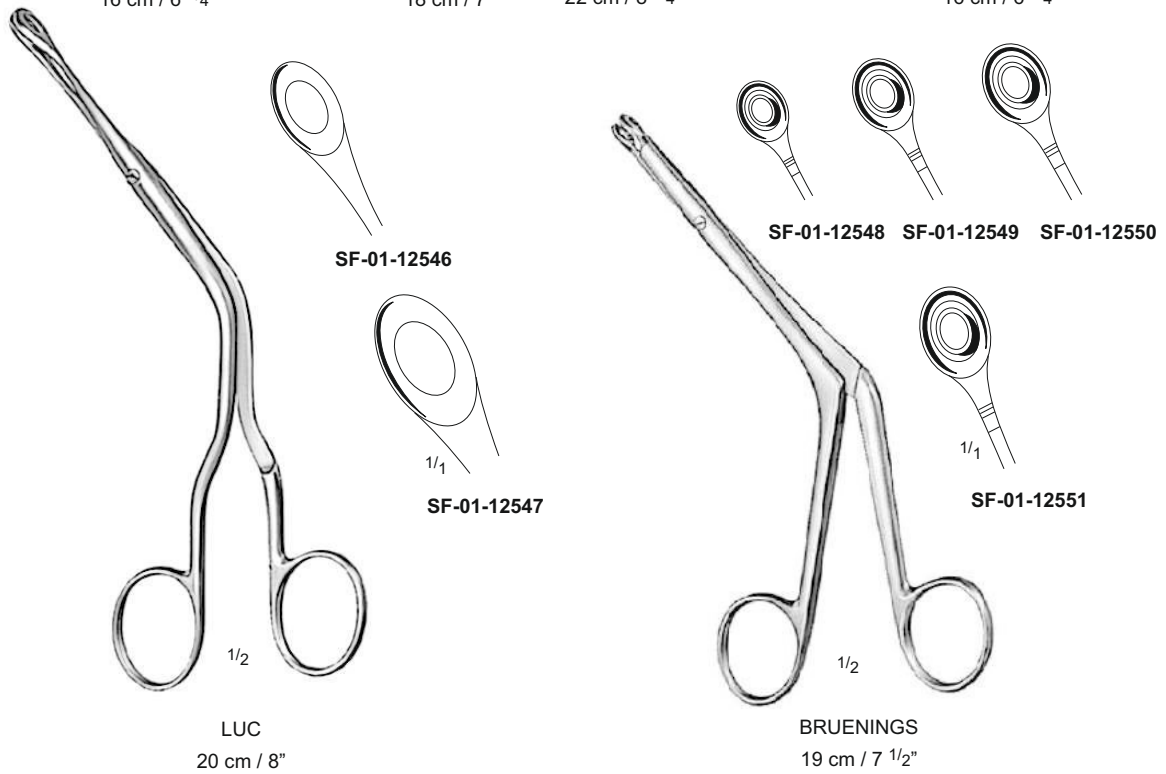

SF-01-12546

SF-01-12548 SF-01-12549 SF-01-12550

SF-01-12547

SF-01-12551

LUC
20 cm / 8"

BRUENINGS
19 cm / 7 1/2"



1/1



SF-01-12552



SF-01-12553



SF-01-12554



SF-01-12555



SF-01-12556



1/1



SF-01-12557



SF-01-12558



SF-01-12559



SF-01-12560



SF-01-12561

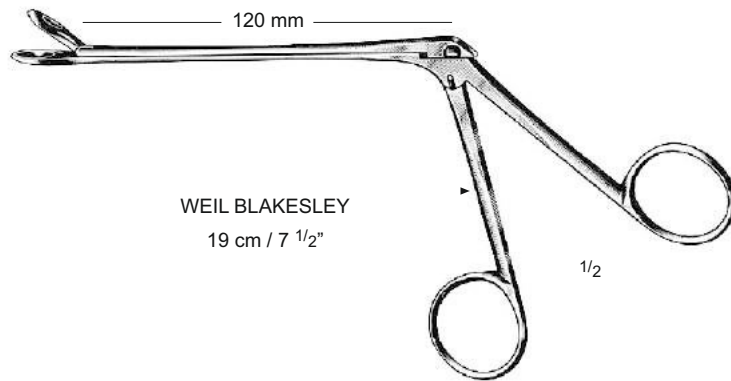

WEIL BLAKESLEY
19 cm / 7 1/2"

1/2

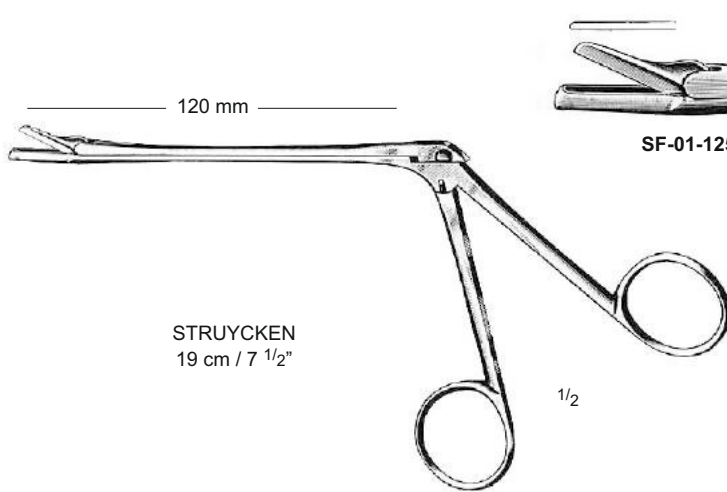

STRUYCKEN
19 cm / 7 1/2"



SF-01-12562

1/1

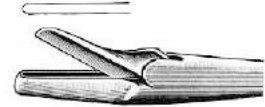

SF-01-12563

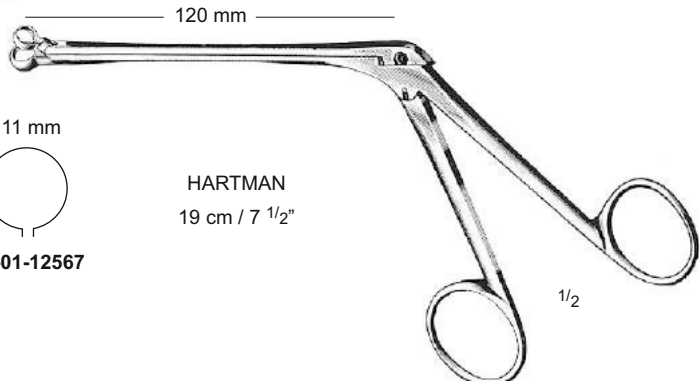

HARTMAN
19 cm / 7 1/2"

1/2



1/1

SF-01-12564

SF-01-12565

SF-01-12566

SF-01-12567

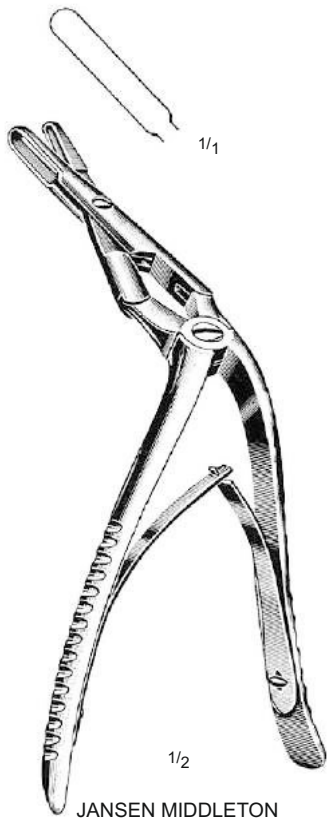

JANSEN MIDDLETON
SF-01-12568
19 cm / 7 1/2"

- 3 mm
SF-01-12569
- 4 mm
SF-01-12570
- 5 mm
SF-01-12571
- 6 mm
SF-01-12572



KERRISON
20 cm / 8"



FOMON
SF-01-12573
15 cm / 6"



JOSEPH
SF-01-12574
15 cm / 6"



CONVERSE
SF-01-12575
12 cm / 4 3/4"

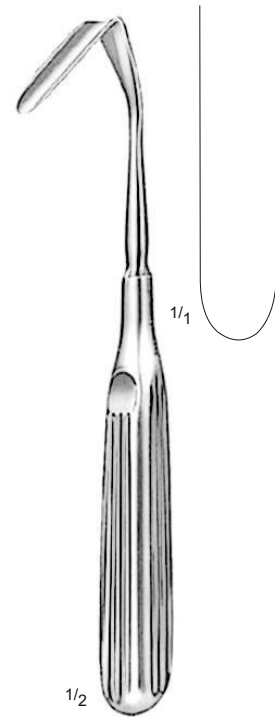

AUFRICHT
SF-01-12576
19 cm / 7 1/2"

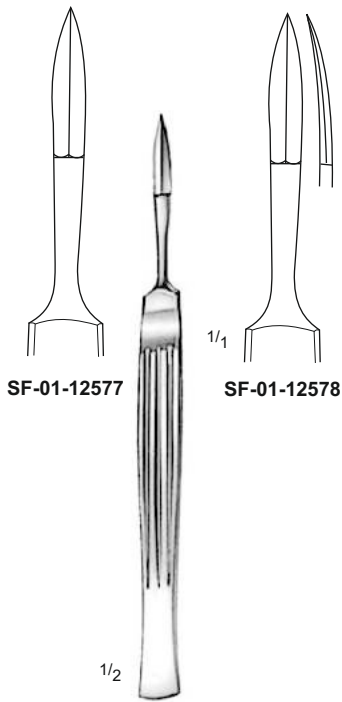

SF-01-12577

SF-01-12578

1/2

JOSEPH
16 cm / 6 1/4"

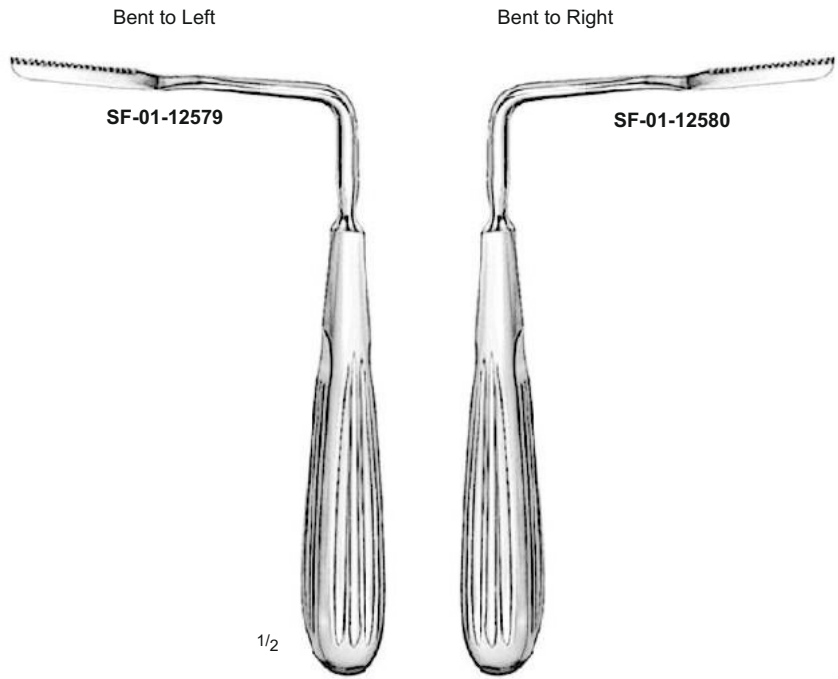

Bent to Left

SF-01-12579

Bent to Right

SF-01-12580

1/2

JOSEPH
17 cm / 6 3/4"

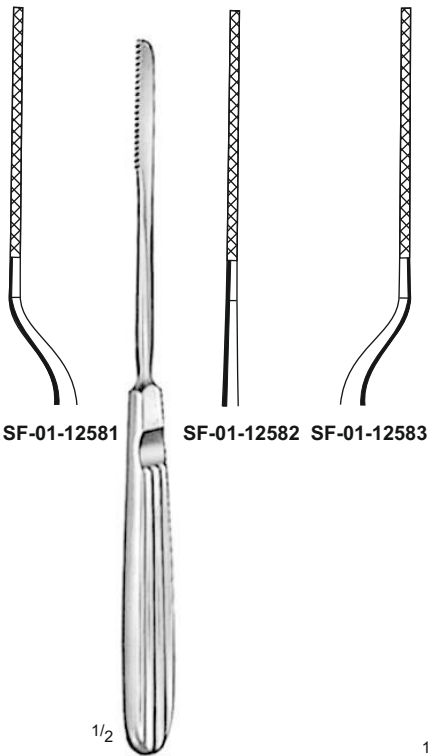

SF-01-12581

SF-01-12582

SF-01-12583

1/2

JOSEPH
19 cm / 7 1/2"

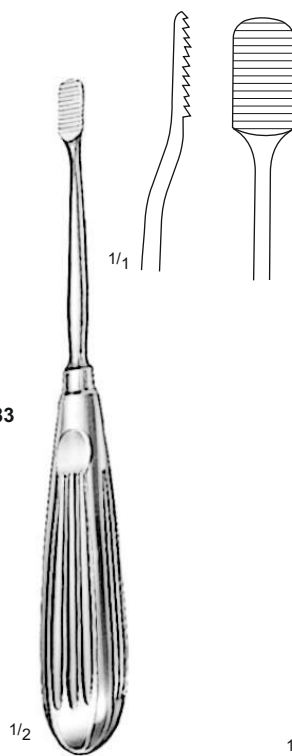

1/1

1/1

1/1

SF-01-12584

SF-01-12585

1/2

LEWIS
SF-01-12586
18 cm / 7"



1/2

AUFRICHT
21 cm / 8 1/4"

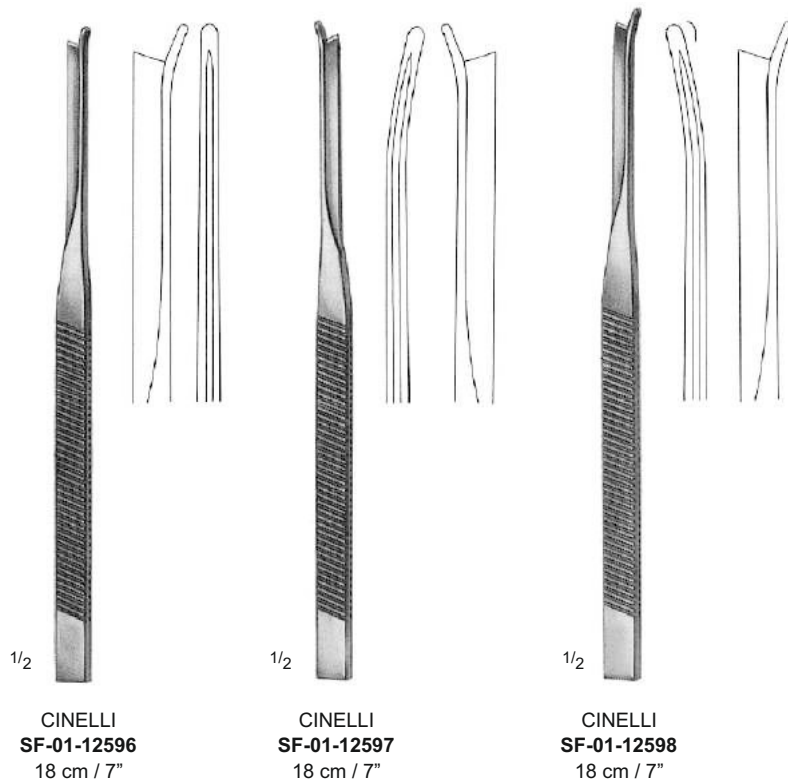
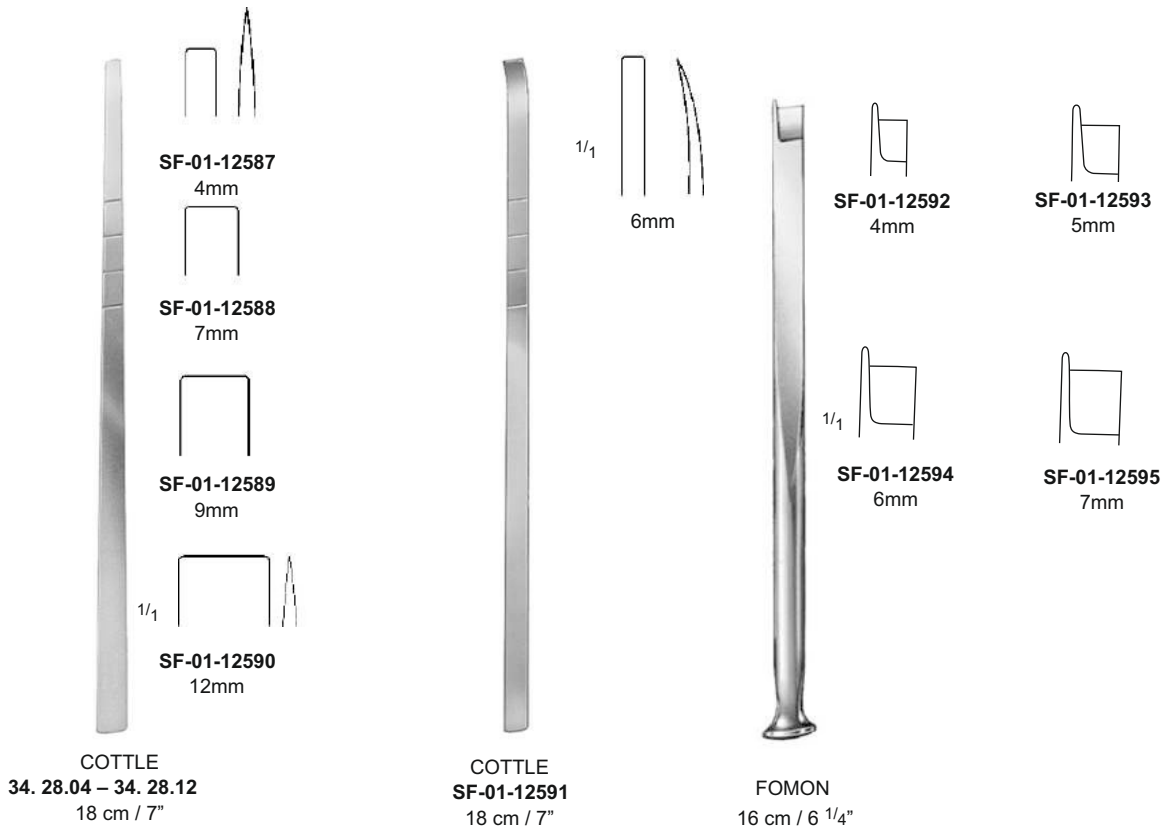

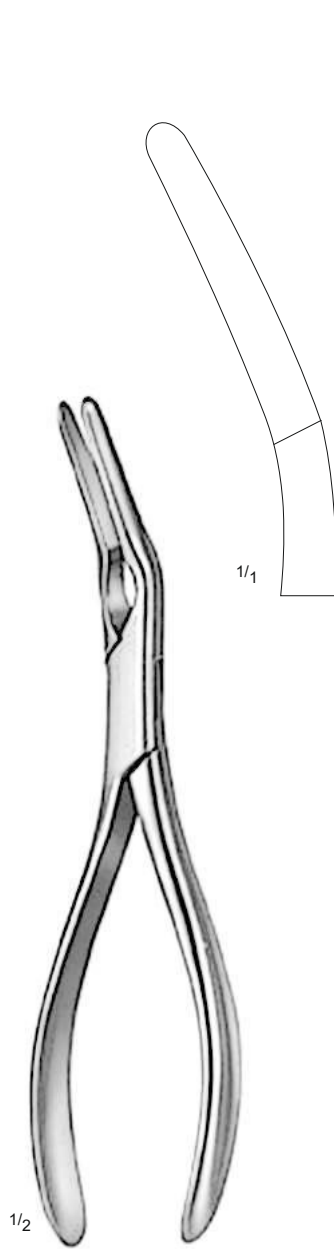

ASCH
SF-01-12602
21 cm / 8 1/4"

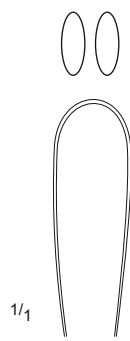

SF-01-12599



SF-01-12600
Left



SF-01-12601
Right



WALSHAM
23 cm / 9"

MOUTH & THROAT



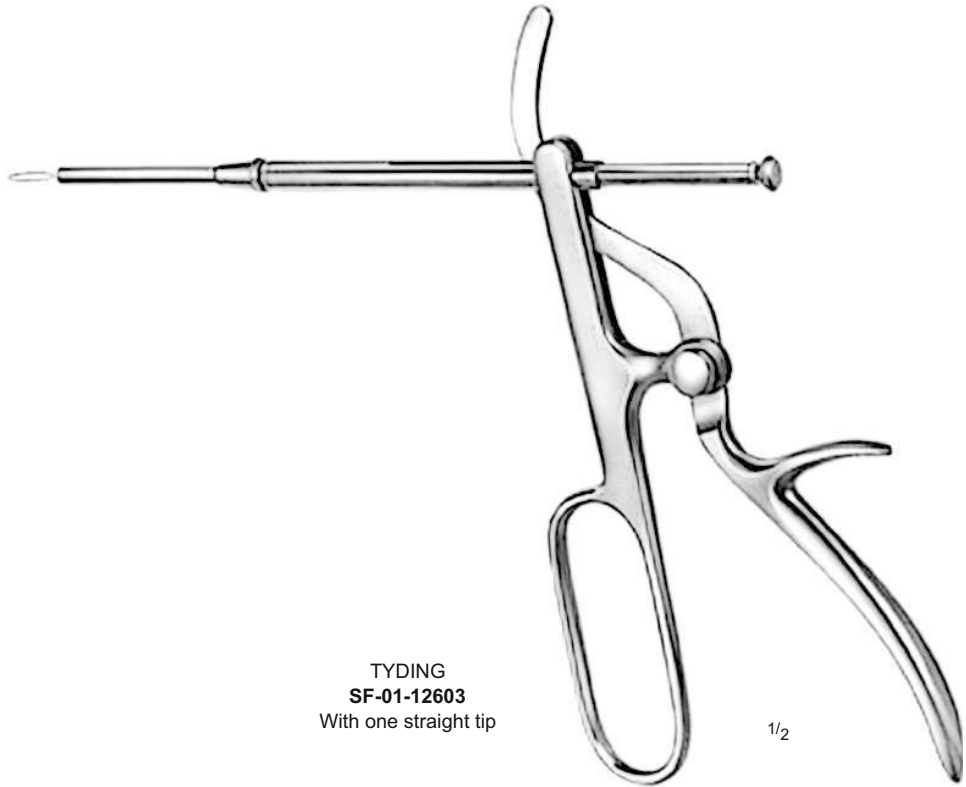

TYDING
SF-01-12603
With one straight tip

1/2



EVES
SF-01-12608
28 cm / 11"

1/2

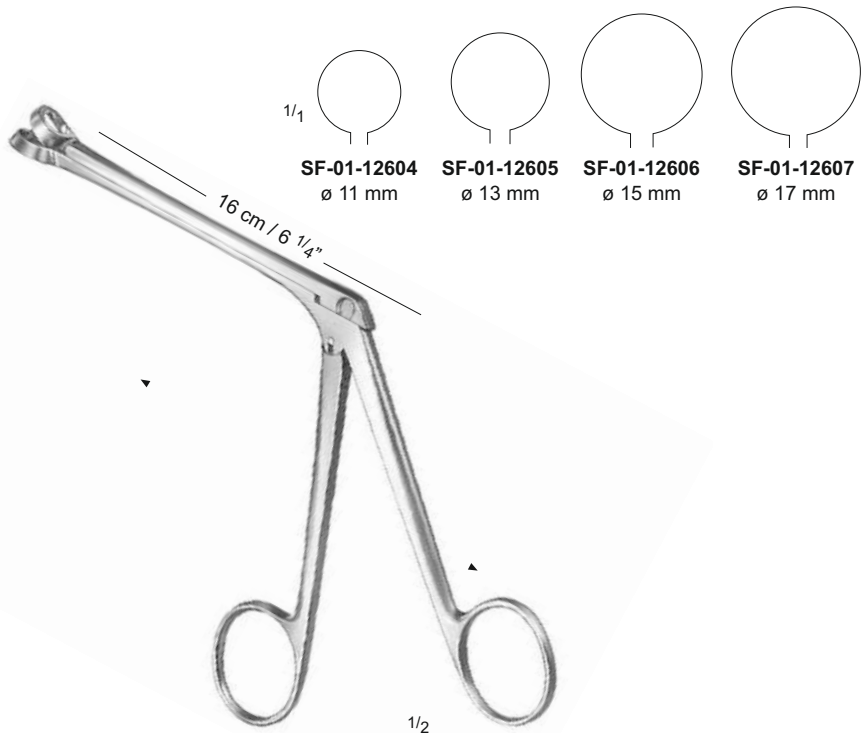

1/1	1/1	1/1	1/1
SF-01-12604	SF-01-12605	SF-01-12606	SF-01-12607
ø 11 mm	ø 13 mm	ø 15 mm	ø 17 mm

16 cm / 6 1/4"

HARTMANN

1/2

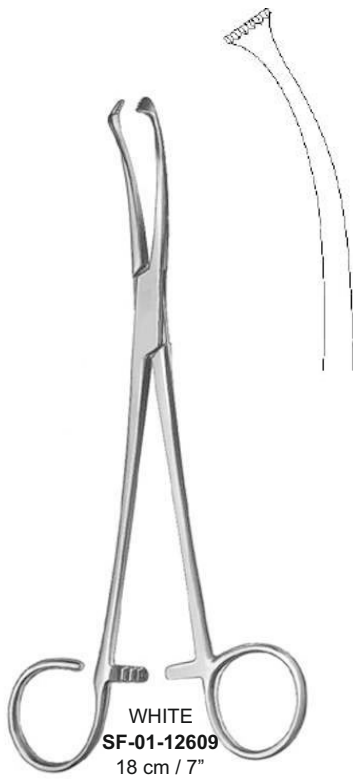

WHITE
SF-01-12609
18 cm / 7"

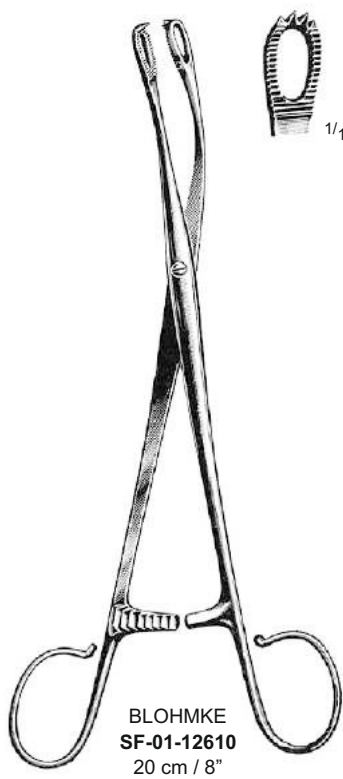

BLOHMKE
SF-01-12610
20 cm / 8"



DEAN
SF-01-12611
17 cm / 6 3/4"



DEAN TC
SF-01-12612
17 cm / 6 3/4"

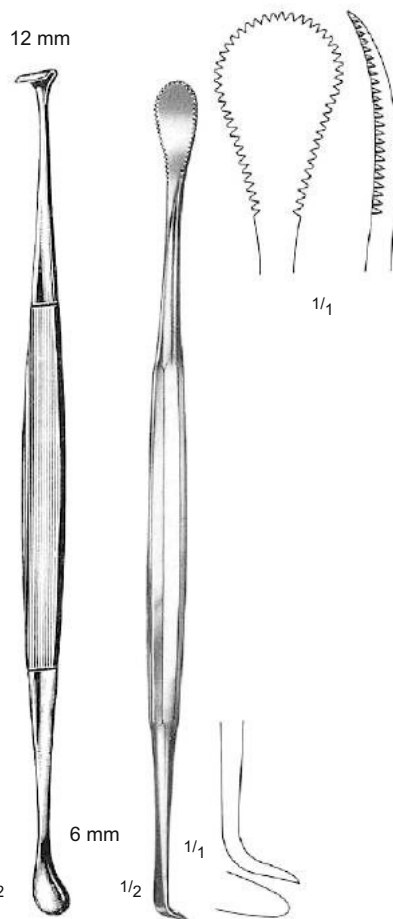

HURD **HENKE**
SF-01-12613 **SF-01-12614**
22.5 cm / 9" 23 cm / 9"

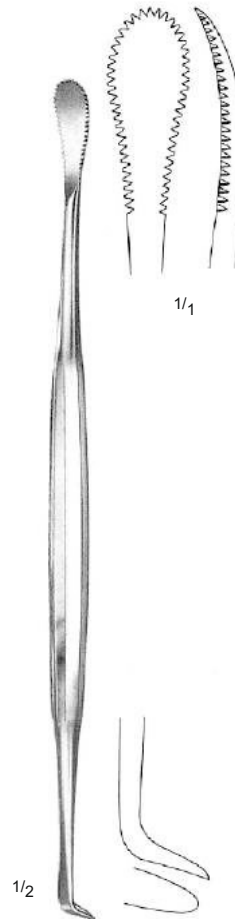

HENKE
SF-01-12615
23 cm / 9"

For Tonsil siezing
Forceps, please see
page no. 59

Fig. 1

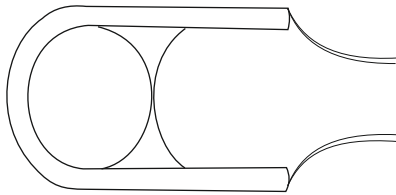

SF-01-12616 - Fig # 1

Fig. 2

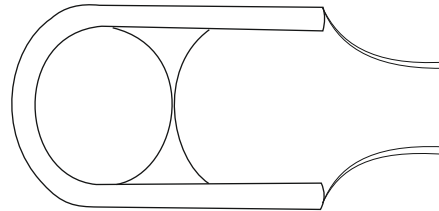

SF-01-12617 Fig # 2

Fig. 3

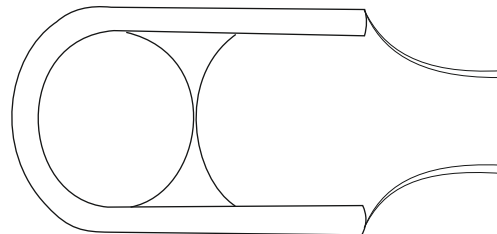

SF-01-12618 Fig # 3

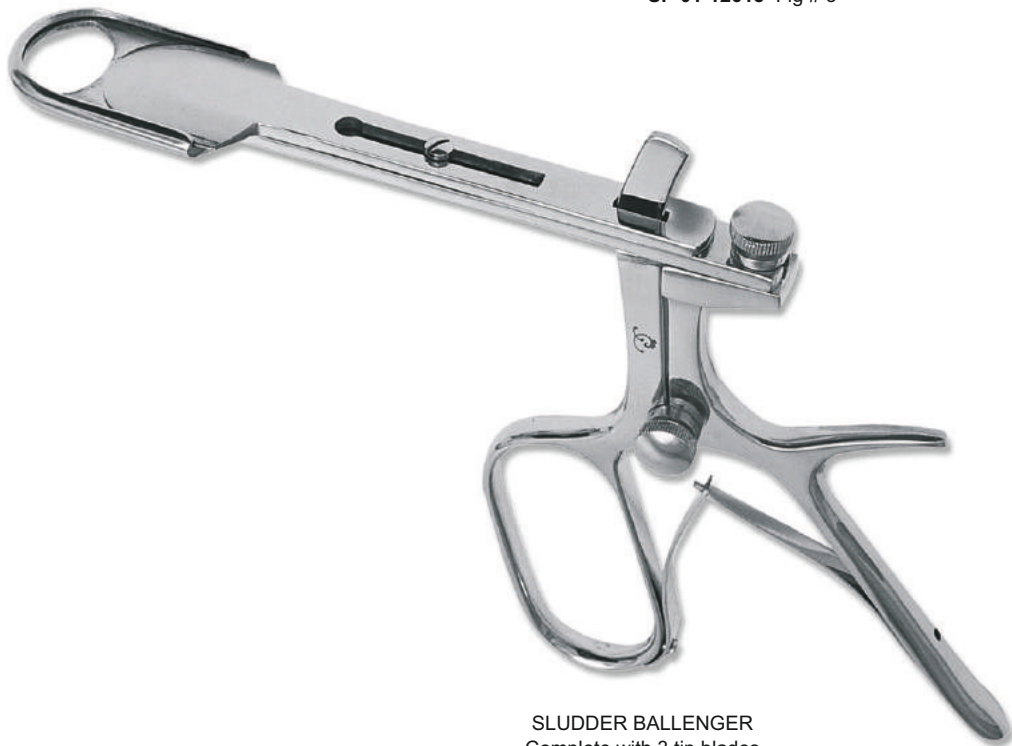

SLUDDER BALLENGER
Complete with 3 tip blades
SF-01-12619

1/2

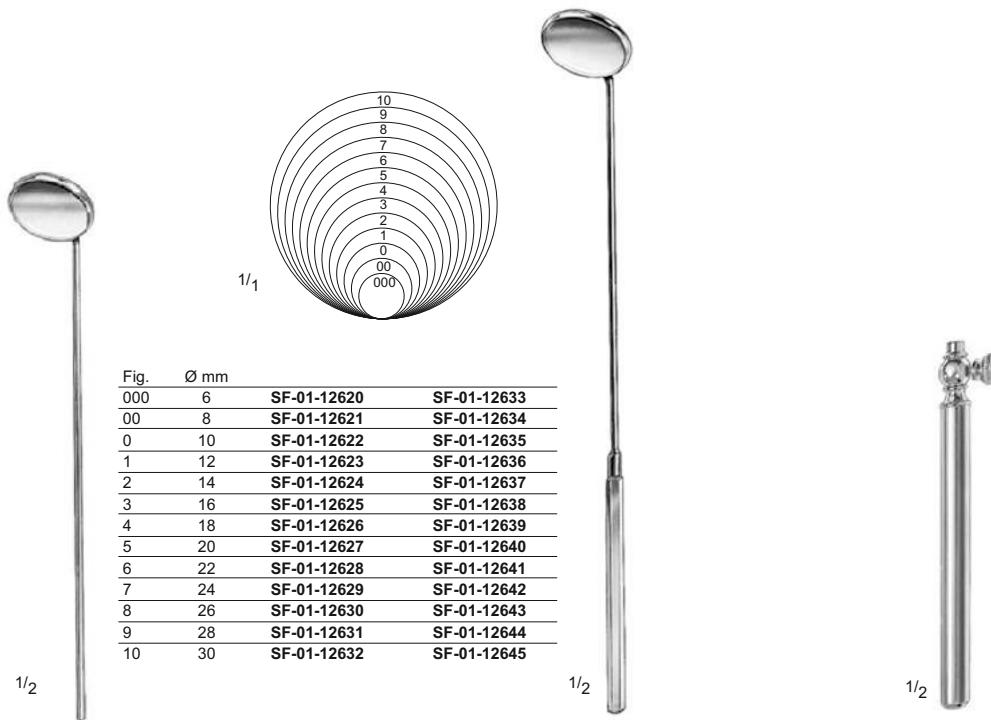

Fig.	Ø mm		
000	6	SF-01-12620	SF-01-12633
00	8	SF-01-12621	SF-01-12634
0	10	SF-01-12622	SF-01-12635
1	12	SF-01-12623	SF-01-12636
2	14	SF-01-12624	SF-01-12637
3	16	SF-01-12625	SF-01-12638
4	18	SF-01-12626	SF-01-12639
5	20	SF-01-12627	SF-01-12640
6	22	SF-01-12628	SF-01-12641
7	24	SF-01-12629	SF-01-12642
8	26	SF-01-12630	SF-01-12643
9	28	SF-01-12631	SF-01-12644
10	30	SF-01-12632	SF-01-12645

Laryngeal Mirror without Handle

12 cm / 4 3/4"

Laryngeal Mirror with Handle

22 cm / 8 3/4"

SF-01-12646
Handle for Laryngeal Mirror
with adjustable Screw

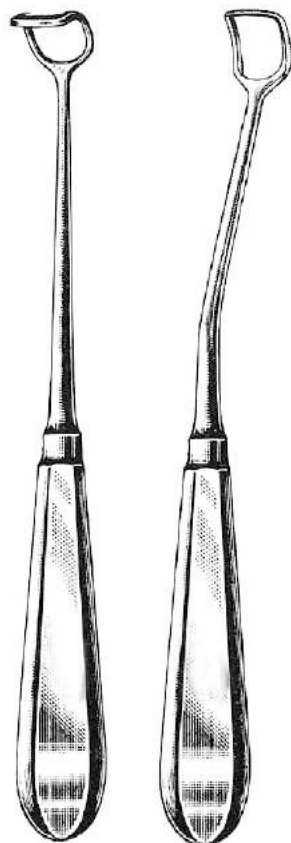

BECKMAN SF-01-12653 - SF-01-12654 22 cm / 8 3/4"
BECKMAN SF-01-12655 - SF-01-12656 22 cm / 8 3/4"

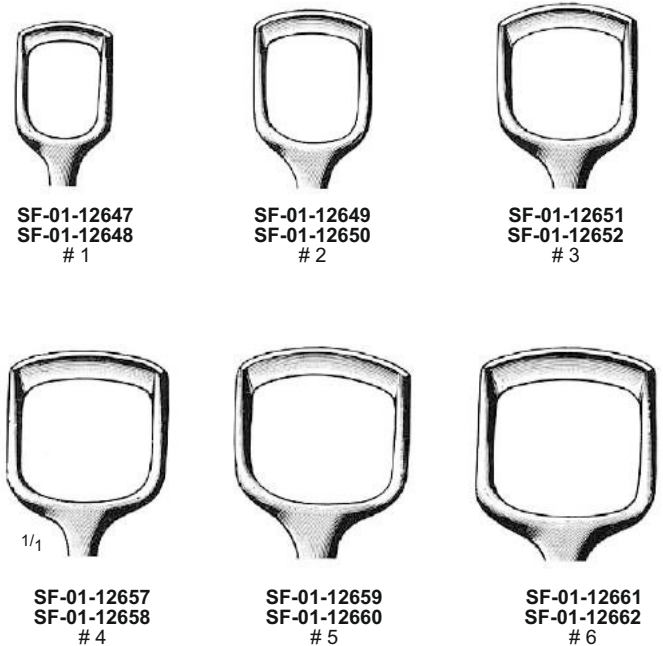

SF-01-12647
SF-01-12648
1

SF-01-12649
SF-01-12650
2

SF-01-12651
SF-01-12652
3

SF-01-12657
SF-01-12658
4

SF-01-12659
SF-01-12660
5

SF-01-12661
SF-01-12662
6

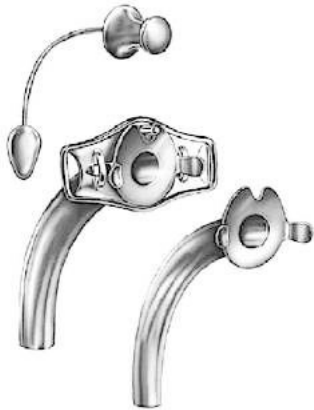

CHEVALIER-JACKSON
36. 33.50 – 36. 33.69



LUER
36. 33.80 – 36. 33.99

Fig	mm ø	German Silver	Silver Plated	German Silver	Silver Plated
0	4	SF-01-12663	SF-01-12673	SF-01-12683	SF-01-12693
1	5	SF-01-12664	SF-01-12674	SF-01-12684	SF-01-12694
2	6	SF-01-12665	SF-01-12675	SF-01-12685	SF-01-12695
3	7	SF-01-12666	SF-01-12676	SF-01-12686	SF-01-12696
4	8	SF-01-12667	SF-01-12677	SF-01-12687	SF-01-12697
5	9	SF-01-12668	SF-01-12678	SF-01-12688	SF-01-12698
6	10	SF-01-12669	SF-01-12679	SF-01-12689	SF-01-12699
7	11	SF-01-12670	SF-01-12680	SF-01-12690	SF-01-12700
8	12	SF-01-12671	SF-01-12681	SF-01-12691	SF-01-12701
9	13	SF-01-12672	SF-01-12682	SF-01-12692	SF-01-12702

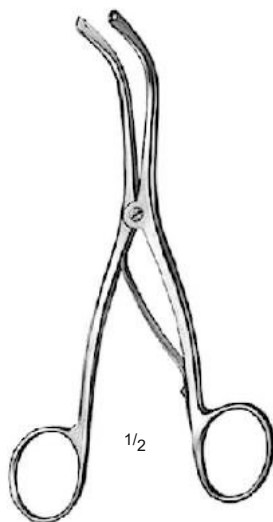

TROUSSEAU
SF-01-12703
14 cm / 5 1/2"



LABORDE
SF-01-12704
14 cm / 5 1/2"



LUKENS
SF-01-12705
17 cm / 6 3/4"



JACKSON
SF-01-12706
17 cm / 6 3/4"

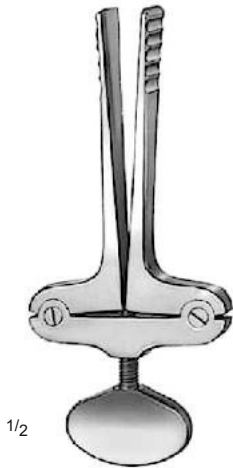

HEISTER
SF-01-12707
13 cm / 5"

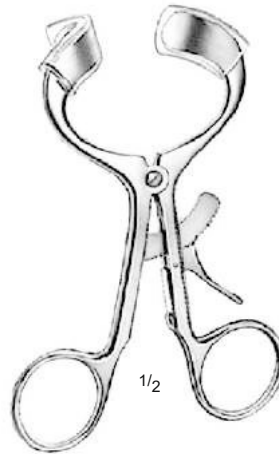

MOLT
SF-01-12708 – 10 cm / 4"
SF-01-12709 – 13 cm / 5"
SF-01-12710 – 15 cm / 6"

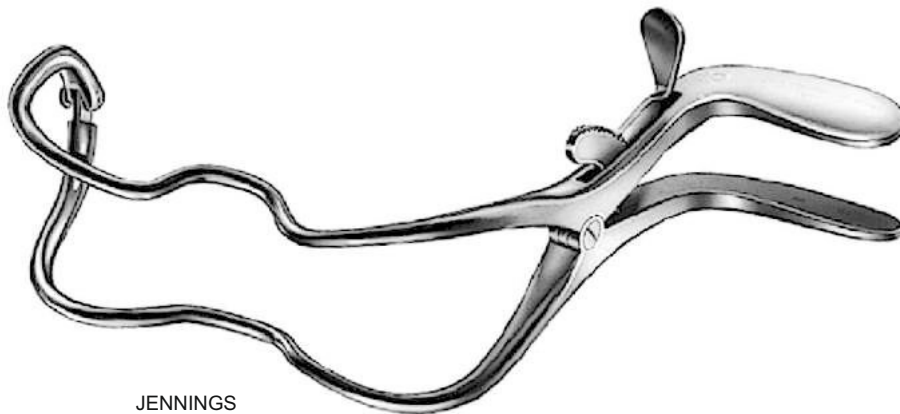

JENNINGS
SF-01-12711 – 9 cm / 3 1/2"
SF-01-12712 – 11 cm / 4 1/2"
SF-01-12713 – 13 cm / 5"
SF-01-12714 – 15 cm / 6"

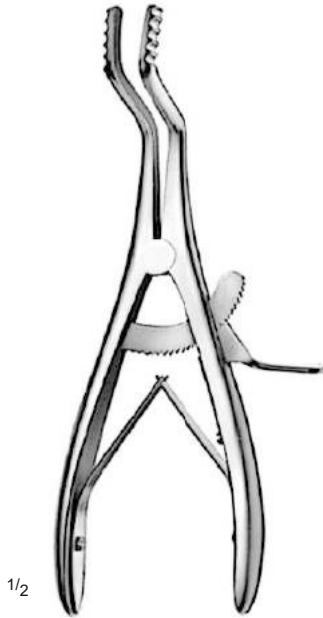

1/2

ROSER - KONIG
SF-01-12715 - 16 cm / 6¹/₄"
SF-01-12716 - 20 cm / 8"

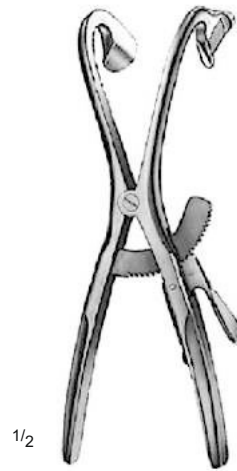

1/2

DENHART
SF-01-12717
13 cm / 5"

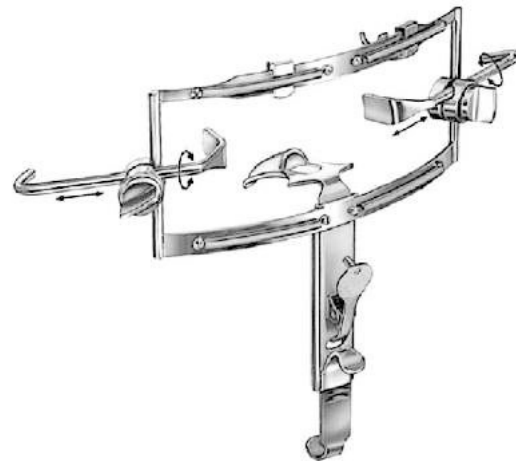

DINGMAN
SF-01-12721
(Complete)



1/2

TOBOLD
SF-01-12722
14 cm / 5 1/2"



1/2

HARTMANN
SF-01-12723
15 cm / 6"



1/2

WIEDER
38. 02.21 – 38. 02.22

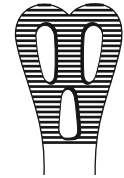

SF-01-12724
14 cm / 5 1/2"

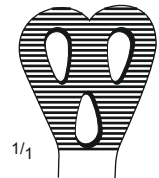

1/4

SF-01-12725
15 cm / 6"



20 mm

1/2

23 mm

SF-01-12726 – 14 cm / 5 1/2"
Stainless Steel

SF-01-12727 – 16 cm / 6 1/4"
Wood



1/2

STERNBERG
SF-01-12728
14.5 cm / 5 3/4"



14 mm

1/2

18 mm

BRUENING
SF-01-12729
19 cm / 7 1/2"

INDEX

DESCRIPTION

A

Abdominal Retractors.....185-190
 Abdominal Spatulas.....162
 Abdominal Scissors.....14
 Adenoid Curettes.....287
 Adson Artery Forceps.....56
 Adson Periosteal Elevators.....126
 Adson Retractors181-183
 Adson Tissue Forceps.....29
 Adson Tissue Forceps with TC Inserts29
 Adson-Baby Artery Forceps.....58
 Adson-Brown Tissue Forceps with TC Inserts.30
 Adson-Brown Tissue Forceps.....30
 Alar Retractors279
 Alderdyce Elevators.....126
 Alderkruetz Tissue Forceps.....28
 Alexander Chisels and Gouges143
 Alexander Uterine Biopsy Forceps.....113
 Allis Atrauma Intestinal Tissue Forceps.....85
 Allis Intestinal Tissue Forceps.....84
 Allis-Adair Intestinal Tissue Forceps84
 Allis-Baby Intestinal Tissue Forceps.....84
 Allison Lung Retractors.....246
 Alm Retractors.....180
 Amniotome.....118
 Amputating Knives.....24
 Amputating Saws.....139
 Aneroid Sphygmomanometer.....3
 Anoscopes.....92
 Antrum Punch Forceps.....252
 Antrum Rasps.....280
 Aorta Dilators.....204
 Aortic Aneurysm Clamps, Atrauma.....195, 197
 Aortic Aneurysm Clamps.....195
 Applicators, Cotton.....5
 Artery & Fistula Scissors.....19
 Artery Forceps.....47-56, 58, 59
 Asch Septum Straightening Forceps282
 Atrauma Aortic Aneurysm Clamps.....195,197
 Atrauma Bronchus Clamps.....197
 Atrauma Bulldog Clamps.....192,202
 Atrauma Cardiovascular Forceps.....193-202
 Atrauma Coarctation Clamps.....193, 198
 Atrauma Intestinal & Stomach
 Clamp Forceps.....85, 86, 88
 Atrauma Intestinal Tissue Forceps.....85
 Atrauma Peripheral Vascular Clamps.....194
 Atrauma Tissue Forceps.....33
 Aufrecht Nasal Raspatories.....280
 Aufrecht Nasal Retractor279
 Auvard Vaginal Specula and retractors96

B

Babcock Atrauma Intestinal Forceps.....85
 Babcock Intestinal Forceps with TC Inserts....85
 Babcock Intestinal Tissue Forceps.....85
 Babinski Percussion Hammer.....2
 Backhaus Towel Clamps.....61
 Backhaus-Roeder Towel Clamps.....61
 Bailey-Gibbon Rib Contractor.....246
 Bailey Rib Contractor.....246
 Bakes Common Duct Dilators.....270
 Balfour - Baby Abdominal Retractor.....188
 Balfour Abdominal Retractors.....188,189
 Ballanger Septum Knives.....276
 Bandage Scissors with TC Inserts.....80
 Bandage Scissors.....78, 80
 Barraquer Cilia Forceps.....39
 Barrett Tenaculum Forceps.....106
 Barth Mastoid Curette.....212
 Battery Handle, Fiber Optic.....230
 Baumgartner Needle Holder with TC Inserts...64

Baumgartner Needle Holder.....64
 Beacham Amniotome.....118
 Beck Vascular Clamps.....201
 Beckmann Adenoid Curettes.....287
 Beckmann Retractor.....183
 Beckmann-Adson Retractors.....184
 Beckmann-Eaton Retractor.....183
 Beebee Wire Cutting Scissors.....76
 Beer Cilia Forceps.....39
 Belluci Micro Ear Scissors.....218
 Bengolea Artery Forceps.....53
 Bergmann Bandage & Plaster Shear.....71
 Berliner Percussion Hammer.....2
 Beyer Bone Rongeur.....154
 Beyer Mastoid Rongeurs.....212
 Billeau Ear-Loops214
 Biopsy Forceps.....93, 115, 113
 Bishop Harmon Eye Forceps.....40
 Bladder Neck Spreaders.....266
 Bladder Retractors.....264, 265
 Bladder Spatula.....264
 Blake Gall Stone Forceps269
 Blohmke Tonsil Forceps.....285
 Blood Pressure Manometers.....3
 Blumenthal Bone Rongeurs.....153
 Bohler Bone Rongeurs.....154
 Bone and Rib Shears.....242
 Bone Chisels and Gouges.....142-149
 Bone Curettes.....150-152
 Bone Cutting Forceps.....131, 132
 Bone Files & Raspatories124
 Bone Files.....124, 280
 Bone Holding & Reposition Forceps.....134
 Bone Holding Clamps.....133
 Bone Holding Forceps.....134-138
 Bone Levers.....128-130
 Bone Rasps.....124
 Bone Rongeur Forceps.....153-156
 Bonney Forceps with TC Inserts.....35
 Bonney Tissue Forceps.....35
 Bowls, Kidney.....238
 Bowls, Round.....239
 Bowls, Solution.....238
 Bowls, Wash.....238, 239
 Boxes, Instrument240
 Boys-Allis Intestinal Tissue Forceps.....84
 Bozemann Dressing Forceps.....44
 Brain Knives.....24
 Brain Spatulas.....255, 260
 Braun Stadler Episiotomy Scissors.....119
 Braun Tenaculum Forceps.....106
 Braun Uterine Depressor.....105
 Breisky Vaginal Specula and Retractors.....100
 Bronchus & Gall Duct Clamps.....59, 197
 Brunchus Forceps.....248
 Bruenings Nasal Septum Forceps.....277
 Bruenings Tongue Depressor.....291
 Brunner Retractors.....174
 Brunner Rib Shears.....242
 Bruns (Volkman) Bone Curettes.....152
 Bruns Bandage & Plaster
 Shear with TC Inserts.....80
 Bruns Bandage & Plaster Shear.....78
 Bruns Bone Curettes.....150, 151
 Bryant Dressing and Sinus Forceps.....42
 Buck Ear Curettes.....213
 Buck Ear Forceps216
 Buck Neurological Hammer.....2
 Bulldog Clamps, Atrauma.....192, 202
 Bulldog Clamps.....46
 Bunt (Mayo) Instrument Holder.....236
 Bunt Safety Pins.....236
 Burford Finochietto Rib Spreaders.....245
 Burrs for Hand Drills.....259

Busch Umbilical Scissors.....119

C

Caliper.....4
 Canulated Probes.....5
 Cardiovascular Forceps, Atrauma.....33, 193-202
 Cardiovascular Forceps.....201
 Castroviejo Needle Holders with TC Inserts....71
 Castroviejo Needle Holders.....71
 Catheters, Eustachian.....213
 Catheter Forceps.....220
 Catheters, Metal.....262
 Catheters, Wash.....272
 Cervical Biopsy & Specimen Forceps.....115, 113
 Cervical Mallets.....123
 Cervical Traction Tongs.....259
 Chapat Artery Forceps.....48
 Charriere Amputating Saw.....139
 Cheatele Sterilising Forceps236
 Cheron Swab Forceps.....43
 Chevalier-Jackson Tracheal Tubes.....288
 Chisels, Bone and Gouges.....142-149
 Cilia Forceps.....39
 Citelli Mastoid Rongeurs.....212
 Clamps, Bulldog.....46
 Clamp Forceps (Atrauma),
 Stomach and Intestinal.....86, 88
 Clamp Forceps.....56-59
 Clamps, Atrauma Aortic Aneurysm.....195, 197
 Clamps, Atrauma Bronchus.....197
 Clamps, Atrauma Bulldog.....192, 202
 Clamps, Atrauma Coarctation.....193, 198
 Clamps, Atrauma Iliac Artery197
 Clamps, Atrauma Ligature.....196
 Clamps, Atrauma Peripheral Vascular.....194
 Clamps, Atrauma Tangential Occlusion.....196
 Clamps, Bone Holding.....133
 Clamps, Bronchus & Gall Duct.....59, 197
 Clamps, Kidney Pedicle.....268, 269
 Clamps, Meatus.....266
 Clamps, Multi-Purpose.....199
 Clamps, Peripheral Vascular.....194
 Clamps, Towel.....61
 Clamps, Tubing.....62
 Clamps, Umbilical Cord.....120
 Cleveland Bone Cutting Forceps.....131
 Cleveland Bone Rongeurs.....153
 Clip Applying and Removing Forceps.....75
 Cloward Lamina Spreader.....258
 Coarctation Clamps, Atrauma.....193, 198
 Collin Abdominal Retractors.....185
 Collin Artery & Tissue Forceps.....60
 Collin Baby Abdominal Retractor.....185
 Collin Clip Removing Forceps.....75
 Collin Duval Grasping Forceps.....36
 Collin Mallet122
 Collin Tissue Seizing Forceps.....60
 Collin Tongue Seizing Forceps220
 Collin Umbilical Cord Clamps.....120
 Collin Uterine Elevating Forceps.....110
 Collin Vaginal Specula.....100
 Comedo Extractors.....232
 Containers for Cotton Wool, Pellets.....238
 Contractors, Rib.....246
 Converse Alar Retractor279
 Cooley Aorta Dilators.....204
 Cooley Atrauma Vascular Forceps33,203
 Coryllos Retractors.....174
 Cottle Dorsal Scissors.....276
 Cottle Nasal Osteotomes.....281
 Cottle Nasal Specula.....274
 Cottle-Kazanjian Bone Cutting Forceps131
 Cotton Applicators.....5
 Cotton Swab Forceps.....43, 44

Cranial Hand Drills.....	259	Douglas Cilia Forceps.....	39	Fomon Chisels.....	281
Crile Artery Forceps.....	49	Doyen Abdominal Scissors.....	14	Fomon Nasal Hooks.....	279
Crile-Murray Needle Holder.....	67	Doyen Atrauma Intestinal Forceps.....	86	Fomon Nasal Scissors.....	276
Crile-Wood Needle Holder with TC Inserts.....	65, 67	Doyen Intestinal Clamp Forceps.....	86	Forceps Artery.....	47-56, 58, 59
Crile-Wood Needle Holder.....	65, 67	Doyen Mallets.....	122	Forceps for Tearing out Toe & Finger Nails.....	233
Crutchfield Cervical Traction Tongs.....	259	Doyen Ovary Seizing Forceps.....	109	Forceps Jars.....	239
Cups, Medicine.....	239	Doyen Retractors.....	173	Forceps, Atrauma Cardiovascular.....	33, 193-202
Cups, Sputum.....	239	Doyen Rib Raspatories.....	246	Forceps, Bone Cutting.....	131, 132
Curettes, Uterine.....	116, 117	Doyen Tumor Screws.....	114	Forceps, Bone Holding.....	133-138
Curettes.....	114, 150-152, 212	Doyen Vaginal Retractors.....	100	Forceps, Bone Rongeur.....	153-156
Cushing Brain Spatulas.....	255	Doyen-Baby Intestinal Clamps.....	86	Forceps, Bronchus.....	59, 248
Cusco Vaginal Specula.....	101	Dressing Forceps.....	26-36, 42-44	Forceps, Cardiovascular Atrauma.....	193-202
Cushing Dressing Forceps.....	34	Dressing Jars.....	238	Forceps, Catheter.....	220
Cushing Forceps with TC Inserts.....	34	Dressing Sterilizing Drums.....	236	Forceps, Cervical Biopsy & Specimen.....	115, 113
Cushing Intervertebral Disc Rongeurs.....	253	Drills Hand.....	259	Forceps, Cilia.....	39
Cushing Raspatories.....	126	Duplay Tenaculum Forceps.....	107	Forceps, Clip Applying and Removing.....	75
Cushing Vein Retractors.....	158	Dura Dissectors.....	255, 256	Forceps, Cotton Swab.....	43-44
Cuticle Nippers.....	234	Duval Collin Tissue Holding Forceps.....	60	Forceps, Cutting Nasal.....	278
Cutting Forceps, Nasal.....	278	Duval Grasping Forceps.....	36	Forceps, Dissecting & Ligature.....	54, 58, 59
D				Forceps, Dressing.....	26-36, 42, 44, 216
Dandy Artery Forceps.....	48	E		Forceps, Ear Dressing.....	37, 215
Dartigues Uterine Elevating Forceps.....	110	Ear Curettes.....	213	Forceps, Ear Polypus.....	216
Davidson Scapular Retractors.....	246	Ear Dressing Forceps.....	37, 216	Forceps, Eye, Micro.....	40
Davis Dura Dissectors.....	255	Ear Hooks.....	214	Forceps, Foreign Body.....	216, 266
Davis-Boyle Mouth Gag.....	221	Ear Knives.....	215	Forceps, Gall Stone.....	269
Day Ear Hook.....	214	Ear Loops.....	214	Forceps, Goitre Seizing.....	59
Dean Scissors with TC Inserts.....	285	Ear Polypus Forceps.....	216	Forceps, Grasping.....	265
Dean Tonsil Scissors.....	285	Ear Polypus Snares.....	208	Forceps, Holding, Tissue and Organ.....	60, 85
Deaver Operating Scissors.....	15	Ear Specula.....	210	Forceps, Hysterectomy.....	55, 111
Deaver Retractors.....	177-179	Ear Syringes.....	213	Forceps, Intestinal Clamps.....	87-90
De Bakey (Crile Wood)		Echlin Laminectomy Rongeurs.....	155	Forceps, Intestinal Tissue.....	84-86
Needle Holder with TC Inserts.....	65	Eicken-Killian Sinus Wash Canulae.....	272	Forceps, Kidney Stone.....	267
De Bakey Aortic Aneurysm Clamps.....	197	Elevating Spoon.....	120	Forceps, Lung Grasping.....	247
De Bakey Atraumatic Bulldog Clamps.....	192,202	Elevators, Periosteal.....	125	Forceps, Micro Ear.....	217
De Bakey Forceps with TC Inserts.....	33	Elevators, Septum.....	276, 277	Forceps, Midwifery.....	118
De Bakey Ligature Forceps.....	196	Elevators.....	125, 212	Forceps, Nasal Cutting.....	278
De Bakey Multipurpose Clamps.....	199	Endocervical Specula.....	105	Forceps, Nasal Polypus.....	37
De Bakey Peripheral Vascular Forceps.....	194	Engel Plaster Cast Knife.....	82	Forceps, Obstetrical (Midwifery).....	118
De Bakey Vascular Clamps.....	200	Enucleation Scissors.....	9	Forceps, Ovary & Polypus Seizing.....	109
De Bakey Vascular Dilators.....	203	Episiotomy Scissors.....	119	Forceps, Peritoneal.....	55, 57
De Bakey Vascular Forceps.....	33	Esmarch Bandage & Plaster Shears.....	78	Forceps, Placenta and Ovum.....	120
Dejerine Percussion Hammer.....	2	Esmarch Plaster Knife.....	82	Forceps, Plaster Cast Bending.....	81
Delicate Scissors.....	9	Eustachian Catheters.....	213	Forceps, Polypus and Dressing.....	215, 216, 273
Delle Obstetrical Forceps.....	118	Eve Tonsil Snare.....	284	Forceps, Rectal Biopsy Specimen.....	93
Denhart Mouth Gag.....	290	Eye Forceps.....	40	Forceps, Scalp Flap.....	118
Depressors, Tongue.....	291	F		Forceps, Septum Straightening.....	282
Depressors.....	105	Farabeuf Bone Holding Forceps.....	137	Forceps, Septum.....	277- 279, 282
Derf Needle Holder with TC Inserts.....	64	Farabeuf Raspatories.....	128	Forceps, Sinus.....	42
Derf Needle Holder.....	64	Farabeuf Retractors.....	163	Forceps, Splinter.....	38, 39
Derra Vascular Clamps.....	201	Farabeuf-Lambotte Bone Holding Forceps.....	137	Forceps, Sterilizing.....	236
Deschamps Ligature Needles.....	72,73	Farrel(Frohn)Cotton Applicators.....	5	Forceps, Swab.....	43, 44
Deschamps-Baby Ligature Needles.....	72	Farrior Ear Specula.....	210	Forceps, Tenaculum.....	107, 108
Desjardins Common Duct Probes.....	270	Faure Peritoneal Clamp Forceps.....	57	Forceps, Tissue.....	27-36, 60
Desjardins Gall Stone Forceps.....	269	Faure Uterine Biopsy Forceps.....	111	Forceps, Tongue Holding.....	220
Desmarres Chalazion Forceps.....	40	Feilchenfeld Splinter Forcep.....	38	Forceps, Tonsil Punch.....	284
Dieffenbach Bulldog Clamps.....	46	Ferguson Bone Holding Forceps.....	134	Forceps, Tonsil Seizing.....	285
Diethrich Vascular Scissors.....	206	Ferris-Smith-Cushing Rongeurs.....	252	Forceps, Towel Clamps.....	61
Diethrich Vascular Clamps.....	46	Ferris-Smith-Kerrison Rongeurs.....	251, 252	Forceps, Tumor Grasping.....	254
Dilators, Gall Duct.....	270	Fiber Optic Battery Handle.....	230	Forceps, Uterine Elevating.....	110
Dilators, Uterine Sets.....	102-104	Fiber Optic Laryngoscope Sets.....	222, 223	Forceps Uterine Polypus.....	109
Dilators, Vascular.....	203	Fiberoptic Laryngoscopes.....	222,224,226	Forceps, Vulsellum.....	108
Dingman Bone Holding Forceps.....	134	Files, Bone.....	124, 280	Foreign Body Levers.....	216
Dingman Mouth Gag.....	290	Fine Operating Scissors.....	20	Forks, Tuning.....	208, 209
Disectors.....	126	Finger Ring Saws.....	232	Fox Dermal Curettes.....	233
Dissecting and Ligature Forceps.....	54, 58, 59	Finocchio Needle Holder.....	69	Frazier Dura Dissectors.....	255
Dissecting Forceps with TC Inserts.....	29-35	Finocchio Rib Spreaders.....	244, 245	Frazier Suction Tubes.....	6
Dissecting Knives.....	23	Finocchio-Baby Rib Spreaders.....	244,245	Freer Nasal Elevator.....	276
Dissecting Knives.....	23	Finocchio-Haight Baby-Rib Spreader.....	244	Friedmann Bone Rongeur.....	153
Dissecting Scissors.....	8, 21, 15, 19	Finocchio Needle Holder with TC Inserts.....	69	Fritsch Retractors.....	171
Dissectors, Dura.....	255, 256	First Aid Dressing & Plaster Shear.....	71	Frykholm Bone Rongeur.....	155
Dissectors, Tonsil.....	285	Flat Nose Pliers with TC Inserts.....	140		
Dissectors.....	126	Flat Nose Pliers.....	140	G	
Dittel Mandrin and Catheter.....	263	Foerster Sponge Forceps.....	44		

Gags, Mouth.....	221	Hartmann-Hoffmann Ear Polypus Forceps.....	216	Kelly Retractor.....	172, 175
Gall Duct Clamps.....	268, 269	Hartmann-Noyes Ear Forceps.....	216	Kelly Scissors with TC Inserts.....	19
Gall Duct Dilators.....	270	Hartmann-Weingartner Ear Forceps.....	216	Kern Bone Holding Forceps.....	136
Gall Stone Forceps.....	269	Head Mirrors.....	4	Kerrison Laminectomy Rongeurs.....	251
Gall Stone Probes.....	270	Heany Hysterectomy Forceps.....	111	Kerrison Nasal Punch Forceps.....	279
Garret Vascular Dilators.....	203	Hegar Uterine Dilators.....	102, 103	Kerrison Rongeurs.....	212
Gauze Applicators.....	82	Hegebarth Clip Applying Forceps.....	75	Kevourkian Uterine Biopsy Forceps.....	113
Gelpi Abdominal Retractors.....	185	Heifetz Brain Spatulas.....	260	Kevourkian-Younger Biopsy Curette.....	114
Gemini Dissecting Forceps.....	59	Heiss Artery Forceps.....	58	Keys Skin Punches.....	233
Gerald Dressing Forceps.....	34	Heister Mouth Gag.....	289	Kidney Bowls.....	238
Gerald Forceps with TC Inserts.....	34	Henke Tonsil Elevator.....	285	Kidney Stone Forceps.....	267
Gerster-Lowmann Bone Holding Clamps.....	133	Hennig Plaster Spreader.....	81	Kielland Obstetrical Forceps.....	118
Gerzog Mallet.....	123	Heymann- Knight Nasal Scissors.....	276	Killian Nasal Specula.....	275
Giertz Rib Shears.....	242	Hibbs Chisels.....	146	Killian Septum Elevators.....	277
Gigli (OliveCrona) Bone Saw.....	139	Hirschmann Anoscopes.....	92	Kilner Skin Hooks.....	233
Gigli Wire Saw Handle.....	139	Hoehn Dissectors.....	255	Kilner Undermining Scissors with TC Inserts.....	19
Gillies Forceps with TC Inserts.....	31	Hoehn Elevators.....	125	Kilner Undermining Scissors.....	19
Gillies Needle Holder with TC Inserts.....	69	Hohmann Bone Levers.....	129, 130	Kirk Mallet.....	122
Gillies Needle Holder.....	69	Hoke Bone Chisels.....	146	Kirschner Abdominal Retractors.....	190
Gillies Skin Hooks.....	159, 233	Holsher Nerve Root Retractors.....	257	Knives Meniscotomy.....	149
Gillies Tissue Forceps.....	31	Hooks, Ear.....	214	Knives, Brain.....	24
Glover Atrauma Vascular Forceps.....	201	Hooks, Skin.....	159, 233	Knives, Nasal.....	276
Glover Atraumatic Bulldog Clamps.....	192	Hooks, Vein.....	158	Knives, Plaster.....	82
Gluck Bone and Rib Shear.....	242	Hopkins Plaster Knife.....	82	Knives.....	23, 24, 215
Goitre Seizing Forceps.....	59	Hryntschak Bladder Retractor.....	264	Kocher (Ochsner) Artery Forceps.....	52
Gorney Plastic Surgery Scissors.....	20	Hudson Cranial Drill.....	259	Kocher Artery Forceps.....	50
Gosset Abdominal Retractors.....	187	Hunter Splinter Forceps.....	38	Kocher Atrauma Intestinal Clamp Forceps.....	88
Gosset-Baby Abdominal Retractor.....	187	Hurd Tonsil Elevator.....	285	Kocher Intestinal Clamp Forceps.....	87
Gouges and Bone Chisels.....	142-149	Hysterectomy Forceps.....	111	Kocher Retractors.....	166
Graefe Retractors.....	159	I		Koerte Abdominal & Intestinal Spatula.....	179
Grasping Forceps.....	265	Iliac Artery Clamps, Atrauma.....	197	Kogan Endocervical Specula.....	105
Graves Vaginal Specula.....	100	Incision Scissors.....	15	Konrich Sterilizing Drums.....	236
Green Armytage Scalp Flap Forceps.....	118	Inge Lamina Spreaders.....	258	Kraus Nasal Snare.....	272
Grooved Directors.....	5	Instrument Boxes.....	240	Krause Ear Polypus Snare.....	208
Gross Ear Hook & Curette.....	214	Instrument Trays.....	237	Krause-Voss Ear Polypus Snare.....	208
Gross-Maier Dressing Forceps.....	42	Intervertebral Disc Rongeurs.....	250, 251	Kraus-Voss Nasal Polypus Snare.....	272
Gruber Ear Specula.....	210	Intestinal and Stomach		Kristeller Vaginal Specula and Retractors.....	97, 98
Gruenwald (Jansen) Dressing		Clamp Forceps Atrauma.....	86		
and Polypus Forceps.....	273	Intestinal and Stomach		L	
Gruenwald (Jansen)Bayonet Forceps.....	37	Clamps(Crushing Clamps).....	90	Laborde Tracheal Dilator.....	288
Guides, Catheter.....	263	Intestinal Clamps Forceps.....	87-89	Lahey Goitre Seizing Forceps.....	59
Guthrie Retractors.....	159	Intestinal Tissue Forceps.....	84-86	Lambert-Kay Vascular Forceps.....	197
Guyon Cathetr Guide.....	263	Iris Delicate Forceps.....	31	Lambotte Bone Chisels.....	142
Guyon Kidney Clamps.....	268, 269	Iris Scissors with TC Inserts.....	8	Lambotte Bone Holding Forceps.....	137
Guyon Urethral Sounds.....	262	Iris Scissors.....	8	Lambotte Raspatories.....	128
Guyon Vessel Clamps.....	268	Israel Retractors.....	168	Lamina Spreaders.....	258
Gynecological scissors.....	119			Laminectomy Rongeurs.....	253, 254
				Landolt Tumour Grasping Rongeurs.....	254
H				Lane Bone Holding Forceps.....	136
Haberer Abdominal Retractors.....	162	J		Lane Towel Clamps.....	61
Haight Rib Spreader.....	243	Jackson Tracheal Retractor.....	288	Lange Hohmann Bone Levers.....	130
Halle Bone Curettes.....	151, 152	Jacobs Vulsellum Forceps.....	108	Langenback Amputating Saw.....	139
Halsey Needle Holder with TC Inserts.....	64, 65	Jansen Ear Forceps.....	215	Langenbeck Bone Holding Forceps.....	134
Halsey Needle Holder.....	64, 65	Jansen Retractor.....	180	Langenbeck Ear Hooks.....	214
Halsted (Adson) Artery Forceps.....	56	Jansen-Middelton Nasal Cutting Forceps.....	279	Langenbeck Periosteal Elevators.....	125
Halsted-Mosquito Artery Forceps.....	47	Jars, Dressing.....	238	Langenbeck Periosteal Raspatories.....	128
Hammers, Orthopedic.....	122, 123	Jars, Forceps.....	239	Langenbeck Resection Knives.....	24
Hammers, Percussion.....	2	Jennings Mouth Gags.....	289	Langenbeck Retractors.....	167
Handle for Laryngeal Mirrors.....	287	Jeweler's Style Forceps.....	38	Langenbeck-Kocher Retractors.....	168
Hank Uterine Dilators.....	104	Johns-Hopkins Bulldog Clamps.....	46	Laryngeal Mirrors.....	287
Harrington Retractors.....	176	Jones Towel Clamps.....	61	Laryngoscope Battery Handles.....	229
Hartmann (Baby Mosquito) Artery Forceps.....	48	Joseph Fine Operating Scissors.....	20	Laryngoscope Sets, Fiber Optic.....	222, 223
Hartmann Bone Rongeur.....	153	Joseph Nasal Hook.....	279	Laryngoscope Sets.....	222, 223
Hartmann Ear Polypus Forceps.....	216	Joseph Nasal Knives.....	280	Laryngoscopes.....	222-230
Hartmann Ear Specula.....	210	Joseph Nasal Saws.....	280	Lebsche Sternal Knife.....	242
Hartmann Eustachian Catheters.....	213	Joseph Septum Elevators.....	277	Lees Bronchus Clamps.....	197
Hartman, Nasal Cutting Forceps.....	278			Legueu Bladder Retractor and Spatula.....	264
Hartmann Nasal Polypus Forceps.....	273	K		Leksell Laminectomy Rongeur.....	155
Hartmann Nasal Punch Forceps.....	278	Kader Retractors.....	179	Leland-Jones Peripheral Vascular Forceps.....	194
Hartmann Tongue Depressor.....	291	Kallmorgen Vaginal Specula and Retractors.....	99	Lempert Curettes.....	212
Hartmann Tonsil Punch Forceps.....	284	Kane Umbilical Cord Clamps.....	120	Lempert Raspatories.....	212
Hartmann Tuning Forks.....	208	Kelly Artery and Fistula Scissors.....	19	Lerche Tissue Forceps.....	28
Hartmann Ear Dressing Forceps.....	216	Kelly Artery Forceps.....	49	Leriche Artery Forceps.....	48
Hartmann-Halle Nasal Specula.....	274	Kelly Ovary Seizing Forceps.....	109	Levers, Bone.....	128-130
		Kelly Proctoscopes.....	92		

Levers, Foreign Body.....	216	Medicine Cups.....	239	Nose Pliers.....	140
Lewin Bone Holding Forceps.....	134	Mega-Cut Wire Cutting Pliers.....	141	Noto Ovary & Polypus Forceps.....	109
Lewis Nasal Raspatories.....	280	Meniscomy Knives.....	149	Novak Biopsy Suction Curette.....	114
Lexer Bone Chisels and Gouges.....	147, 149	Mercury Blood Pressure Manometer.....	3	O	
Lexer Operating Scissors.....	15	Metal Catheters.....	262	Obstetrical (Midwifery) Forceps.....	118
Lexer-Baby Dissecting and Strabismus Scissors.....	9	Metzenbaum Dissecting Scissors.....	16	Ochsner Ribbon Retractors.....	162
Leyla Brain Retractor.....	260	Metzenbaum Fine Scissors with TC Inserts.....	18	Ochsner (Rochester) Artery Forceps.....	52
Ligature Needles.....	72-74	Metzenbaum Scissors with TC Inserts.....	17	Oldberg Laminectomy Rongeurs.....	254
Ligature Scissors.....	75	Metzenbaum-Nelson Dissecting Scissors.....	16	Olivecrona Brain Spatulas.....	255
Lister Bandage Scissors with TC Inserts.....	80	Meyerding Retractors.....	161	Olsen-Hegar Needle Holder with TC Inserts.....	69
Lister Bandage Scissors.....	79	Michel Clip Applying & Removing Forceps.....	75	Olsen-Hegar Needle Holder.....	69
Lister Dressing and Sinus Forceps.....	42	Michel Clip Applying Forceps.....	75	O' Connor Skin Hook.....	159
Liston Amputating Knives.....	24	Micro Ear Forceps.....	217	Operating Scissors with TC Inserts.....	11
Liston Bone Cutting Forceps.....	131	Micro Ear Scissors.....	218	Operating Scissors.....	10
Liston-Mini Bone Cutting Forceps.....	132	Micro Mosquito Artery Forceps.....	47	Organ and Tissue Holding .Forceps.....	36, 60, 85
Littauer Ligature Scissors.....	75	Micro-Adson Forceps with TC Inserts.....	30	Osteotomes, Nasal.....	281
Lloyd-Davis (St.Marks) Pelvis Retractors.....	94	Micro-Ason Tissue Forceps.....	30	Otoscope Sets.....	211
Loops Ear.....	214	Micro-Kerrison Rongeurs.....	251	Ovary and Polypus Seizing Forceps.....	109
Love Nerve Root Retractors.....	257	Micro-Needle Holders.....	71	P	
Love-Gruenwald Disc Rongeurs.....	253	Micro-Needle Holders.....	71	Paracentesis Needles.....	215
Lovelace Tissue and Organ Holding Forceps.....	247	Middeldorpf Retractors.....	170	Parker Langenbeck Retractors.....	163
Luc Nasal Septum Forceps.....	277	Midwifery Forceps.....	118	Partsch Bone Chisels and Gouges.....	143
Lucae Bayonet Dressing Forceps.....	37, 215	Mikulicz Peritoneal Clamp Forceps.....	57	Payr-Baby Intestinal and Stomach Clamps.....	90
Lucae Ear Forceps.....	215	Mikulicz Retractor.....	175	Payr-Intestinal and Stomach Clamps.....	90
Lucae Ear Hooks.....	214	Miller Laryngoscopes.....	223, 227, 228	Pean (Rochester) Artery Forceps.....	51
Lucae Mallets.....	123	Millin Bladder Neck Spreader.....	266	Pean Artery Forceps.....	50
Lucae Tuning Forks.....	209	Millin Capsule Grasping Forceps.....	265	Pean Dressing Forceps.....	50
Luer Bone Rongeurs.....	153	Mini Ryder (Vascular) Needle Holder with TC Inserts.....	67	Pean Vaginal Specula.....	100
Luer Tracheal Tubes.....	288	Mini-Hohmann Bone Levers.....	128	Pederson Vaginal Specula.....	100
Lukens Tracheal Retractor.....	288	Mini-Lambotte Bone Chisels.....	142	Pelvimeters.....	118
Lung Grasping Froceps.....	247	Mini-Langenbeck Retractors.....	161	Pelvis Retractors.....	94
Lung Spatulas.....	246	Mini-Lexer Bone Chisels & Gouges.....	149	Penfield Dura Dissectors.....	256
Lupus Curettes.....	233	Mirrors, Head.....	4	Pennington Tissue Holding Forceps.....	60
M		Mirrors, Laryngeal.....	287	Percussion Hammers.....	2
MacDonald Dissectors.....	126	Mixer Artery Forceps.....	58	Periosteal Elevators.....	125
Magill Catheter Forceps.....	220	Mixer Clamp Forceps.....	59	Periosteal Raspatories.....	125-128
Mallets.....	122, 123	Mixer-Babay Dissecting Forceps.....	58	Peripheral Vascular Clamps, Atrauma.....	194
Mandrin and Catheter Guide.....	263	Moldenhauer Ear Hook.....	214	Peritoneal Forceps.....	55, 57
Manometers, Blood Pressure.....	3	Molt Mouth Gags.....	289	Phaneuf Peritoneal Clamp Forceps.....	57
Marquardt Bone Rongeur.....	155	Mouth Gags.....	221	Pinard Fetal Stethoscope.....	3
Martin Pelvimeter.....	118	Moynihan Clamps Forceps.....	56	Pins, Safety.....	236
Martin Uterine Sound.....	105	Moynihan Hysterectomy Clamps.....	56	Placenta and Ovum Forceps.....	120
Martin Vaginal Retractor.....	96	Multi Purpose Clamps, Atrauma.....	199	Plaster Cast Bending Forceps.....	81
Martyle Leaf Probe.....	5	Museux Vulsellum Forceps.....	108	Plaster Cast Instruments.....	78-82
Masson Needle Holder.....	68	Myoma Instruments.....	114	Plaster-of-Paris-Shears.....	79
Masson Needle Holder with TC Inserts.....	68	N		Pliers, Flat Nose.....	140
Mathieu Foreign Body Forceps.....	266	Naegele Obstetrical Forceps.....	118	Pliers, Wire Cutting with TC Inserts.....	140, 141
Mathieu Needle Holder with TC Inserts.....	70	Nail Cutters.....	234	Pliers, Wire Cutting.....	140, 141
Mathieu Needle Holders.....	70	Nail Instruments.....	232-234	Politzer Ear Knives.....	215
Mathieu Rectal Specula.....	91	Nail Nippers.....	234	Politzer Ear Specula.....	210
Mathieu Vaginal Specula and Retractors.....	97	Nail Scissors.....	234	Polloson Retractor.....	176
Mathieu-Kocher Needle Holder with TC Inserts.....	70	Nasal Chisels.....	281	Pomeroy Ear Syringes.....	213
Mathieu-Kocher Needle Holders.....	70	Nasal Cutting Forceps.....	278	Poole Scution Tubes.....	6
Mayo Hegar Needle Holder with TC Inserts.....	66	Nasal Dressing Forceps.....	37, 273	Potts Cardiovascular Forceps.....	193
Mayo Hegar Needle Holder.....	66	Nasal Knives.....	276	Potts-Smith Dressing Forceps.....	32
Mayo Operating and Dissecting Scissors.....	12	Nasal Osteotomes.....	281	Potts-Smith Forceps with TC Inserts.....	32
Mayo Scissors with TC Inserts.....	12	Nasal Polypus Forceps.....	37	Potts-Smith Scissors with TC Inserts.....	205, 206
Mayo-Blake Gall Stone Forceps.....	269	Nasal Rasps.....	280	Potts-Smith Tissue Forceps.....	32
Mayo-Harrington Dissecting Scissors.....	15	Nasal Retractors.....	279	Potts-Smith Vascular Scissors.....	205, 206
Mayo-Robson Intestinal Clamp Forceps.....	89	Nasal Saws.....	280	Pozzi Tenaculum Forceps.....	106
Mayo-Stille Operating and Dissecting Scissors.....	13	Nasal Scissors.....	276	Presbyterian Hospital Tubing Clamps.....	62
Mayo-Stille Scissors with TC Inserts.....	13	Nasal Snares.....	272	Price-Thomas Bronchus Clamps.....	248
Mcldone Plastic Surgery Scissors.....	20	Nasal Specula.....	274, 275	Probes, Gall Stone.....	270
McIndoe Dressing Forceps.....	31	Needle Holders with TC Inserts.....	64-71	Probes.....	5
McIndoe Forceps with TC Inserts.....	31	Needle Holders, Micro.....	71	Proctoscopes.....	92
McIntosh Laryngoscopes.....	222-225	Needle Holders.....	64-71	Professional Cotton Applicators.....	5
McIvor Mouth Gag.....	221	Needles, Paracentesis.....	215	Professional Nasal Specula.....	274
Mead Bone Rongeurs.....	153	Needles, Reverdin.....	74	Professional Nerve Root Retractors.....	257
Mead Mallet.....	123	Nelaton Grooved Director.....	5	Professional Neurological Pin Wheel.....	3
		Nelson Tissue Forceps.....	36	Professional Ribbon Retractors.....	162
		Nerve Root Retractors.....	257	Professor Medina Forceps.....	112
		Neurological Pin Wheel.....	3	Prostatectomy Instruments.....	265, 266
		Newman Sphincteroscopes.....	92	Prostatic Retractors.....	265, 266

TC Bandage Scissors.....	80	Uterine Curettes.....	116, 117	Z	Zaufal Ear Hook.....	214	
TC Dissecting Forceps.....	29-35	Uterine Dilators.....	102-104	Zaufal-Jansen Bone Rongeur.....	154	Zenker Dissecting Forces.....	54
TC Flat Nose Pliers.....	140	Uterine Elevating Forceps.....	110	Zenker Retractors	169	Ziegler Head Mirror.....	4
TC Intestinal Tissue Forceps.....	85	Uterine Polypus Forceps.....	109				
TC Needle Holders.....	64-71	Uterine Scoops.....	115				
TC Plaster-of-Paris Shears.....	80	Uterine Sounds.....	105				
TC Scissors.....	8						
TC Wire Cutting Pliers.....	140-141	V					
Teale Vulsellum Forceps	108	Vaginal Forceps.....	268				
Tenaculum Forceps.....	107, 108	Vaginal Specula and Retractors.....	96-101				
Tenotomy Scissors.....	9	Vaginal Specula.....	96-101, 105				
Thoms Gaylor Uterine Biopsy Forceps.....	112	Valleix Uterine Sound	105				
Thoms-Aliss Intestinal Tissue Forceps.....	84	Van-Buren Urethral Sounds.....	262				
Thomson-Walker Bladder Retractor.....	264	Van-Doren Uterine Biopsy Forceps.....	111				
Thorek Gall Bladder Scissors.....	270	Vascular Clamps Peripheral.....	194				
Thudicum (Goldsmith) Nasal Specula.....	275	Vascular Dilators.....	203				
Tieck-Halle Nasal Specula.....	274	Vascular Scissors.....	205, 206				
Tilley Nasal Polypus Forceps	273	Verbrugge Bone Holding Forceps	138				
Tissue and Organ		Vienna Pattern Nasal Specula.....	275				
Holding Forceps (Atrauma).....	85	Virchow Amputating and Brain Knives.....	24				
Tissue and Organ		Volkman Bone Curettes.....	151, 152				
Holding Forceps.....	60, 84, 85, 244-247	Volkman Retractors.....	164, 165				
Tissue Forceps.....	27-36	Volkman Scoops	152				
Tissue Holding Forceps.....	36, 60						
Tobold Tongue Depressor.....	291	W					
Toennis-Adson Dissecting Scissors.....	19	Wagener Ear Hooks.....	214				
Toennis-Adson Scissors with TC Inserts	19	Walsham Septum Straightening Forceps	282				
Tongue Depressors.....	291	Wangensteen Needle Holder with TC Inserts..	68				
Tongue Holding Forceps.....	220	Wangensteen Needle Holder.....	68				
Tonsil Scissors.....	285	Wartenberg Neurological Pin Wheel.....	3				
Tonsil Dissectors.....	285	Wash Bowls.....	238, 239				
Tonsil Punch Forceps.....	284	Wash Cannulae, Antrum and Frontal Sinus..	272				
Tonsil Seizing Forceps.....	285	Wash Catheters.....	272				
Tonsil Snares.....	284	Waugh Dressing Forceps	32				
Tonsillectomes.....	286	Waugh Forceps with TC Inserts.....	32				
Towel Clamp Ball and Socket	61	Webster Needle Holder with TC Inserts.....	64				
Towel Forceps.....	61	Webster Needle Holder.....	64				
Toynbee Ear Specula	210	Weil-Blakesley Nasal Cutting Forceps.....	278				
Trachea Retractors.....	288	Weitlaner Retractors.....	180				
Trachea Tubes.....	288	Weitlaner-Beckmann Retractors	182				
Tracheal Retractors.....	160	Wertheim Clamp Forceps.....	56				
Trays, Instrument.....	237	Wertheim-Cullen Kidney Clamp.....	268				
Trocars.....	6	White Tonsil Seizing Forceps.....	285				
Troeltsch (Wilde) Ear Dressing Forceps..	37, 215	Wickstrom Artery Forceps.....	58				
Troeltsch Dressing and polypus Forceps	273	Wieder Tongue Depressors.....	291				
Troemner Percussion Hammer.....	2	Williams Intestinal Tissue Forceps.....	84				
Trousseau Tracheal Dilator.....	288	Williger Bone Curette.....	152				
Tubbs Aorta Dilators.....	204	Williger Mallets.....	122				
Tubes, Suction.....	6	Williger Periosteal Elevators.....	125				
Tubes, Trachea.....	288	Williger Raspatories	126				
Tubing Clamps.....	62	Winter Placenta & Ovum Forceps	120				
Tuffier Artery Forceps.....	48	Wire Cutting Pliers with TC Inserts.....	140, 141				
Tuffier Rib Spreader.....	243	Wire Cutting Pliers.....	140, 141				
Tumor Grasping Forceps.....	254	Wire Cutting Scissors With TC Inserts.....	76				
Tuning Forks.....	208, 209	Wire Extracting Forceps.. ..	140, 141				
Tuttle (Singley) Tissue Forceps.....	36	Wire Saws.....	139				
Tyding Tonsil Snare.....	284	Wire Scissors.....	76				
Tympanum Knives.....	215	Wis-Foregger Laryngoscopes.....	225, 226				
Tympanum Needles.....	215	Wolf Dermal Curettes.....	233				
		Wolff-Boehler Plaster Cast Spreader.....	81				
U		Wright (Derf) Needle Holder with TC Inserts..	65				
Ulrich Bone Holding Forceps.....	135	Wright (Derf) Needle Holder.....	65				
Umbilical Bush Umbilical Cord Scissors	119	Wullstein Ear Forceps	216				
Umbilical Cord Clamps.....	120	Wullstein Micro Ear Scissors	218				
Umbilical Cord Scissors.....	119						
Universal Bandage Scissors.....	71	Y					
Universal Scissors with TC Inserts.....	76	Yankauer Suction Tubes.....	6				
Universal Trocars.....	6	Yasargil Pituitary Ronguers.....	254				
Universal Wire Cutting		Yeoman Rectal Biopsy Forceps.....	93				
Scissors with TC Inserts.....	76	Young Prostatic Retractors.....	265				
Universal Wire Cutting Scissors.....	76, 78	Young Tongue Seizing Forceps	220				
Unna Comedo Extractor	232						
Unna-Vidal Comedo Extractor	232						

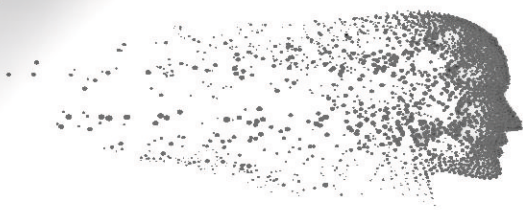

Thank you for your interesting of
SURGI FACT[®] products



☎ +91-98155-11065, +91-98154-11065

✉ vaishanavsurgical@gmail.com

📷 Vaishanav Surgical Co. (@vaishanavsurgical)

🌐 www.surgifact.in



1382 / 1046, VSCO House, Raja Garden, Near Water Tank,
Basti Danishmandan, Jalandhar - 144002